

Nikon

Inverted Microscope

ECLIPSE TE2000-E

ECLIPSE TE2000-U

ECLIPSE TE2000-S

Instructions

Thank you for purchasing the Nikon products.

This instruction manual is written for the users of the Nikon's inverted microscopes "ECLIPSE TE2000-E, ECLIPSE TE2000-U, ECLIPSE TE2000-S" and describes the basic operations of the microscope.



To ensure correct usage, read this manual carefully before operating the instrument.

- It is prohibited to reproduce or transmit this manual in part or whole without Nikon's expressed permission.
- The contents of this manual are subject to change without notice.
- Although every effort has been made to ensure the accuracy of this manual, if you note any points that are unclear or incorrect, contact your nearest Nikon representative.
- Some of the products described in this manual may not be included in the set you have purchased.
- Be sure to read the instruction manual for any other products used in combination with the microscope.
- If you purchased the TE2000-E model, be sure to read the instruction manual supplied with the T-HUBC HUB controller.
- If you are using the TE2000-U/S together with the T-HUBC HUB controller, be sure to read the instruction manual supplied with the T-HUBC HUB controller.

Warning / Caution symbols used in this manual

Although Nikon products are designed to provide you with the utmost safety during use, incorrect usage or disregard of the instructions can cause personal injury or property damage. For your safety, read the instruction manual carefully and thoroughly before using the instrument. Do not discard this manual but keep it near the product for easy reference.

In this manual, safety instructions are indicated with the symbols shown below. Be sure to follow the instructions indicated with these symbols to ensure correct and safe operation.

Symbol	Meaning
 WARNING	Disregarding instructions marked with this symbol may lead to death or serious injury.
 CAUTION	Disregarding instructions marked with this symbol may lead to injury or property damage.

Meaning of symbols used on the equipment

Symbol	Meaning
	Caution for heat. This marking at the top part of the Dia-illuminator and the 12V100W lamphouse calls your attention on the following; <ul style="list-style-type: none">• Lamphouse becomes very hot during and immediately after the illumination.• Risk of burns. Do not touch the lamphouse during and immediately after the illumination.• Make sure that the lamphouse is sufficiently cool before the lamp replacement.



WARNING

1. Intended product use.

This microscope should only be used for microscopic observation. Do not use it for any other purpose.

2. Do not disassemble.

Disassembly may cause malfunction and / or electrical shock. Do not disassemble any part other than those described in this manual. If you experience any problem with the microscope, notify your nearest Nikon representative.

3. Check the Input Voltage.

This microscope uses a power supply for the lamp.

When using the power supply TE-PS30 or TE-PSE30:

Make sure that the input voltage indication on the rear panel matches your regional voltage supply. If the voltages do not match, do not use the microscope; instead, notify your nearest Nikon representative.

Using the power supply with the wrong input voltage may cause a short circuit or fire. It may also cause damage to the microscope.

When using the power supply TE2-PS100W:

If you are using the power supply TE2-PS100W, there is no need to check the input voltage since the input voltage of this power supply is AC 100-240V and can be used at any place in the world.

4. Check the AC adapter of the HUB controller (when using the T-HUBC HUB controller).

The HUB controller is powered by the AC adapter. Be sure to use the specified adapter model meeting the requirements given below. Use of any other type of adapter can result in malfunction, excessive heating, and/or fire.

- To prevent malfunction and/or fire, be sure to use the AC adapter in a well-ventilated location. To ensure that it radiates heat properly and does not overheat, never cover or place any object on the adapter.
- To prevent malfunction, always turn off the power switch (switch to "O") of the HUB controller before attaching the AC adapter.
- Specified AC adapter
 - Manufacturer: Tamura Corp.
 - Model: EXA1230N
 - Rated input voltage: AC 100-240 V, 0.9 A, 50/60 Hz
 - Rated output voltage: DC 12 V
 - Rated output current: 3 A
 - Others: UL Recognized product, GS approved, CE satisfied

5. Power cord

■ Power cord for power supply

To prevent electric shock, always turn off the power switch (switch to "O") for the power supply before attaching or detaching the power cord. Use one of the power cords specified below. Use of an improper power cord can result in fire or other hazard. Also note that the power supply is classified as subject to protection class I against electric shock. Therefore, be sure to connect it to a protective ground terminal.

- Using units in areas where the supply voltage is 100 to 120 V
 - UL Listed detachable power cord set, 3 conductor grounding Type SVT, No. 18 AWG, 3 m long maximum, rated at 125 V AC minimum.
- Using units in areas where the supply voltage is 220 to 240 V
 - Approved according to EU/EN standards, 3 conductor grounding Type HO5VV-F, 3 m long maximum, rated at 250 V AC minimum.

■ Power cord for AC adapter of the HUB controller

To prevent electric shock, always turn off the power switch (switch to "O") of the HUB controller before attaching or detaching the power cord. Always connect one of the power cords specified below. Use of an improper power cord can result in fire or other hazard.

- Using units in areas where the supply voltage is 100 to 120 V
 - UL Listed detachable power cord set, 2 conductor Type SPT-1, No.18 AWG, 3 m long maximum, rated at 125 V AC minimum.
- Using units in areas where the supply voltage is 220 to 240 V
 - Approved according to EU/EN standards, 2 conductor Type HO3VVH2-F, 3 m long maximum, rated at 250 V AC minimum.

6. Heat from the light source.

- The lamp and the lamphouse become extremely hot by the lamp illumination. To avoid burns, do not touch the lamphouse while the lamp is lit or for thirty minutes after it has been turned off.

- To avoid the risk of fire, do not place fabric, paper or highly flammable volatile materials such as gasoline, petroleum benzine, paint thinner or alcohol near the lamphouse while the lamp is lit or for about thirty minutes after it has been turned off.
- The bottom plate of the power supply becomes hot during use. Do not cover up the ventilation holes on the side of the power supply.

CAUTION

- 1. Check the combination of the lamp, dia-illuminator and power supply.**
The dia-illuminator and the power supply must be used in correct combination against the ratings of the lamp and the regional voltage supply. See page 37 to find out the correct combination of these items. Using the equipment in wrong combination will lead to fire, electric shocks or malfunction of the equipment.
- 2. Turn off the power during assembly, connection/disconnection of the cords, and lamp replacement.**
To prevent electric shocks and/or malfunction, always turn off the power switch of the power supply and the T-HUBC HUB controller (flip it to the O side) and unplug the power cord from the wall outlet before assembly, connecting or disconnecting of the cords, and the lamp replacement.
- 3. Cautions on lamp replacement.**
To avoid burns, wait at least 30 minutes after the lamp is turned off so that the lamp can cool sufficiently. To avoid electric shocks and malfunction, always turn off the power switch (flip it to the O side) and unplug the power cord from the wall outlet before lamp replacement.
Securely attach the lamphouse cover to the lamphouse after replacing the lamp. Never light the lamp while the lamphouse cover is open.
- 4. Do not wet the microscope.**
If the instrument gets wet, a short circuit may result that may cause malfunction or abnormal heating. If you accidentally spill a liquid on the instrument, immediately turn off the power switch (flip to the O side) and unplug the power cord from the wall outlet. Then use a dry cloth to wipe away the moisture. If any liquid gets inside the instrument, do not use it; instead, notify your nearest Nikon representative.
- 5. Weak electromagnetic waves.**
This microscope emits weak electromagnetic waves. The accuracy of any precision electronic equipment may be adversely affected if positioned too close. If the microscope affects TV or radio reception, move the radio or TV further away from the microscope.
- 6. Cautions on assembling and installing the microscope.**
 - Be careful not to pinch your fingers or hands during the assembly.
 - The scratches and dirt such as fingerprints on the optical parts (such as lens and filters) will adversely affect the microscope image. Be careful not to scratch or directly touch the lens and filters.
 - This product is a precision optical instrument. Using or storing it under unsuitable conditions may damage it or may have an adverse effect on its accuracy. See the installation conditions on page 4 and use the product in an adequate environment.
- 7. Cautions on moving the microscope.**
When moving the microscope, do not hold it by the focusing knobs, eyepiece tube, stage, dia-illuminator etc., since these parts can be damaged, or they could come off. Hold the microscope by the bottom front and bottom rear.
- 8. Be careful of the protruding rack of the T-SR rectangular stage.**
The rack of the T-SR rectangular stage will protrude by the stage movement. Be careful not to strike your hands against the rack when reaching the focusing knobs or revolving nosepiece. You may get yourself hurt by the edge of the rack.

Notes on handling the microscope

1. Handle the microscope gently.

This product is a precision optical instrument. Handle it carefully, and do not subject it to strong shocks. The precision of the objectives in particular can be adversely affected even by weak shocks.

2. Dirt on the lens.

The scratches and dirt such as fingerprints on the optical parts (such as lens and filters) will adversely affect the microscope image. If these parts get dirty, clean them following the instructions described on "Care and maintenance" at the end of this manual.

3. Dirt on the lamps.

Do not touch the lamp by bare hands. Dirt or fingerprints on the lamp will cause uneven illumination and shortens the life of the lamp. When handling lamps, wear gloves.

4. Installation location.

Using or storing the microscope under unsuitable conditions may damage it or may have an adverse effect on its accuracy. The following conditions should be kept in mind when selecting the installation location.

- Choose a flat surface with little vibration.
- Avoid a brightly lit location such as a room that receives direct sunlight.
- Choose a location that is free from dust or dirt.
- Do not install the microscope in a warm (60°C or more), humid (85% or more) location. (Mold or condensation will form on the lenses and filters.)
- Leave enough space against the nearby wall since the lamphouse will become hot by lamp illumination.
- When using the "T-DH dia-illuminator 100W", leave a certain space between the microscope and the nearby wall to allow the user to look at the caution symbols on the dia-illuminator and the lamphouse. If you are planning to use the tilting function of the "T-DH dia-illuminator 100W", even more space is needed for the illuminator to tilt backward.
- The room light just above the microscope may come into the objective as an extraneous light. (Especially when using a condenser lens with longer working distance such as SLWD, ELWD and LWD lenses.) To avoid this, we recommend to turn off the room light above the microscope when observing the image.

5. Focusing knobs.

- Never turn the focus knobs on the left and right sides of the microscope in opposite directions at the same time, as doing so can result in damage to the microscope.
- Turning the coarse focus knob as far as it will go and then attempting to turn it further will result in damage to the microscope. Never use undue force to turn the knob.

6. Protect the ports.

When not using any of the ports, be sure to attach the supplied cap to it. If not, extraneous light and dusts will enter the microscope.

Contents

Warning / Caution symbols used in this manual	1
Meaning of symbols used on the equipment.....	1
⚠ WARNING	2
⚠ CAUTION	3
Notes on handling the microscope.....	4
I. Parts of the microscope and their names	6
1. Eyepiece tubes and eyepieces	7
2. Microscope base	8
3. Dia-illuminators	12
4. Condensers.....	13
5. Stages, focusing module.....	14
6. Microscope rear	15
7. Power supplies	16
II. Microscopy	17
1. Microscope system consisting of TE2000-U, dia-illuminator 100W, system condenser, and T-TD eyepiece tube D.....	19
2. Microscope system consisting of TE2000-S, dia-illuminator 30W, SLWD condenser, and T-TS eyepiece tube S	24
3. Microscope system consisting of TE2000-E, dia-illuminator 30W, SLWD condenser, and T-TS eyepiece tube S	28
4. Photomicrography (using a 35-mm camera mounted on the front port)	33
III. Operation of each part	36
1. Power ON/OFF.....	37
2. Brightness adjustment.....	38
3. Optical path switching	39
4. Using filters.....	40
5. Using field diaphragm.....	40
6. Using condenser aperture diaphragm	41
7. Eyepiece tube turret.....	42
8. System condenser	42
9. Objectives.....	43
10. Diopter adjustment	45
11. Focusing module.....	45
12. T-DH dia-illuminator 100W.....	47
13. T-SR rectangular stage.....	48
14. Photomicrography.....	49
IV. Assembly	52
V. Troubleshooting	59
VI. Care and maintenance	62
VII. Electrical specifications.....	63

I. Parts of the microscope and their names

Parts of the microscope can be selected according to your purpose.

Exceptionally, the combination of the lamp, dia-illuminator and the power supply is fixed. Never use these parts in combination other than specified.

(Refer to page 37 for the correct combination of the lamp, dia-illuminator and the power supply.)

The T-HUBC HUB controller, which mounts on the rear side of the microscope, allows the user to control attached motorized units. For details, refer to the instruction manual provided with the T-HUBC HUB controller.

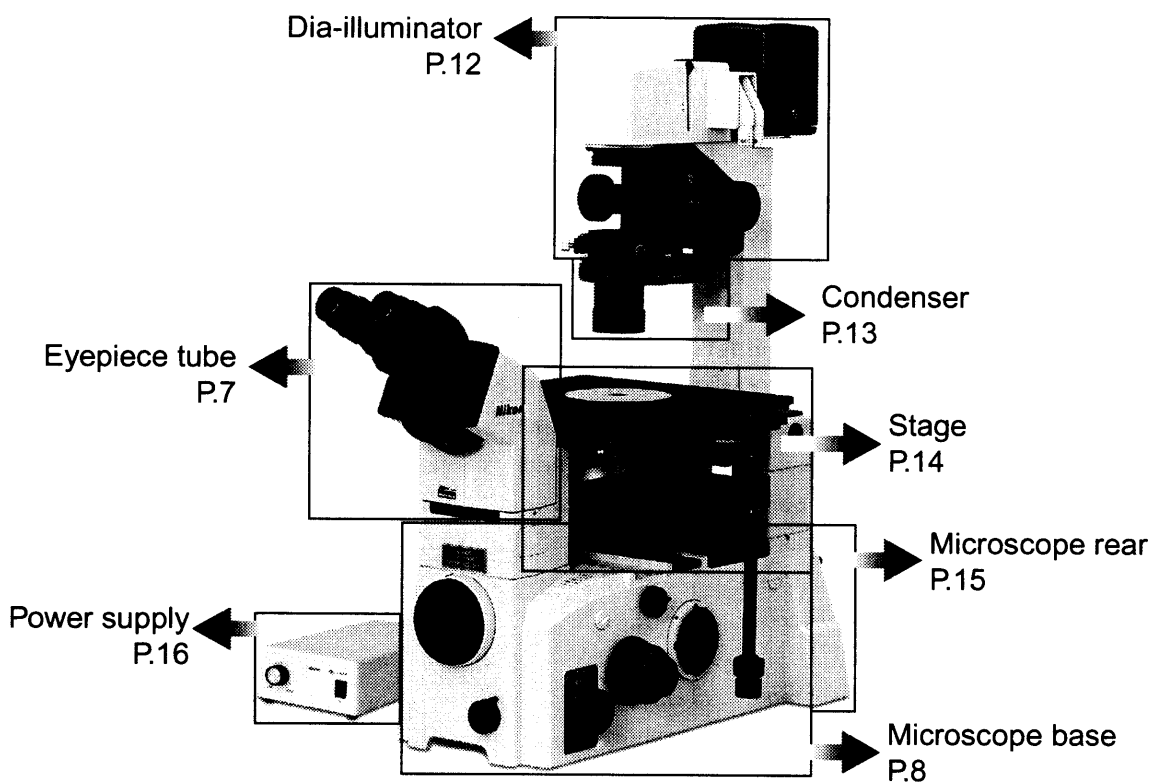

This is a photograph of TE2000-U microscope with T-DH dia-illuminator 100W, LHS-H100P-1 12V100W lamphouse, 12V100W halogen lamp, TE2-PS100W power supply, T-SR rectangular stage, T-TD binocular eyepiece tube D, CFI 10X eyepieces, T-N6 sextuple nosepiece, system condenser, objectives, power cord, etc.

1. Eyepiece tubes and eyepieces

The following eyepiece tubes can be mounted on the observation port of the microscope.

T-TD eyepiece tube D

- A: Diopter adjustment ring
- B: Eyepiece
- C: Eyepiece tube turret
 - O: Open
 - B: Bertrand lens (with focusing screw)
 - C: Close (Shutter)
 - M: 2.5X magnifier

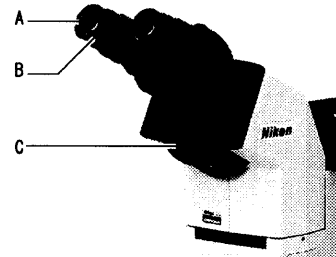

T-TS eyepiece tube S

- A: Diopter adjustment ring
- B: Eyepiece

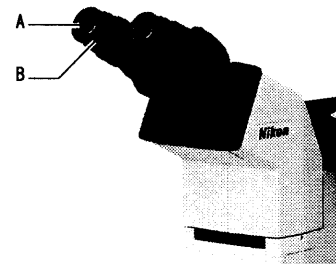

T-TERG ergonomic eyepiece tube

- A: Diopter adjustment ring
- B: Eyepiece
- C: Eyepiece tube turret
 - O: Open
 - B: Bertrand lens (with focusing screw)
 - C: Close (Shutter)

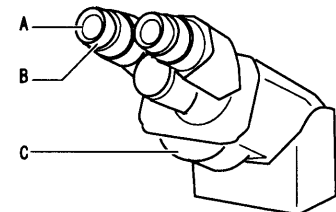

T-TI intermediate tube

- A: Clamp screw for holding various devices
- B: Mount for various devices
 - such as
 - Trinocular eyepiece tube for upright microscopes
 - Teaching head

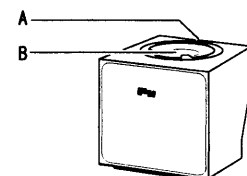

2. Microscope base

Note: Be sure to cover unused ports with supplied caps to prevent the entry of external light and dust.

TE2000-E, right side

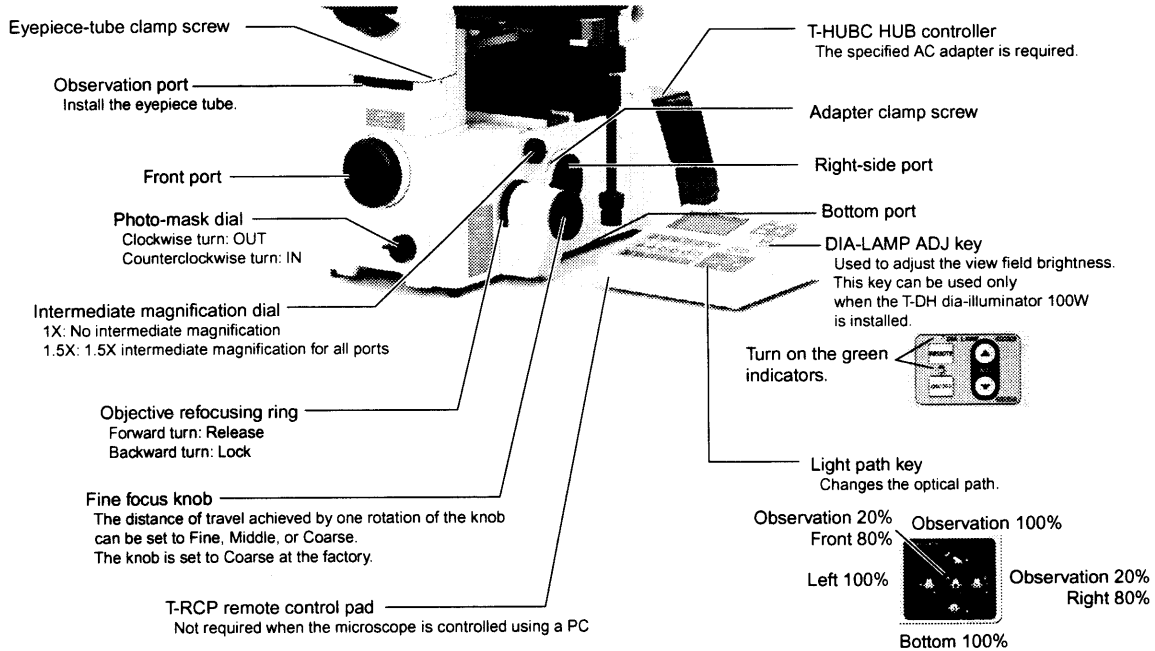

TE-2000E, left side

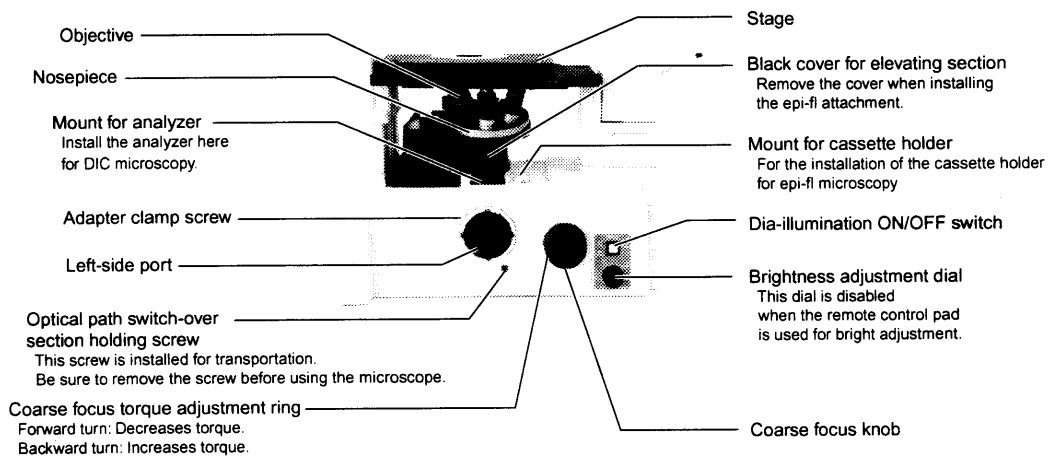

Note: Be sure to cover unused ports with supplied caps to prevent the entry of external light and dust.

TE2000-U, right side

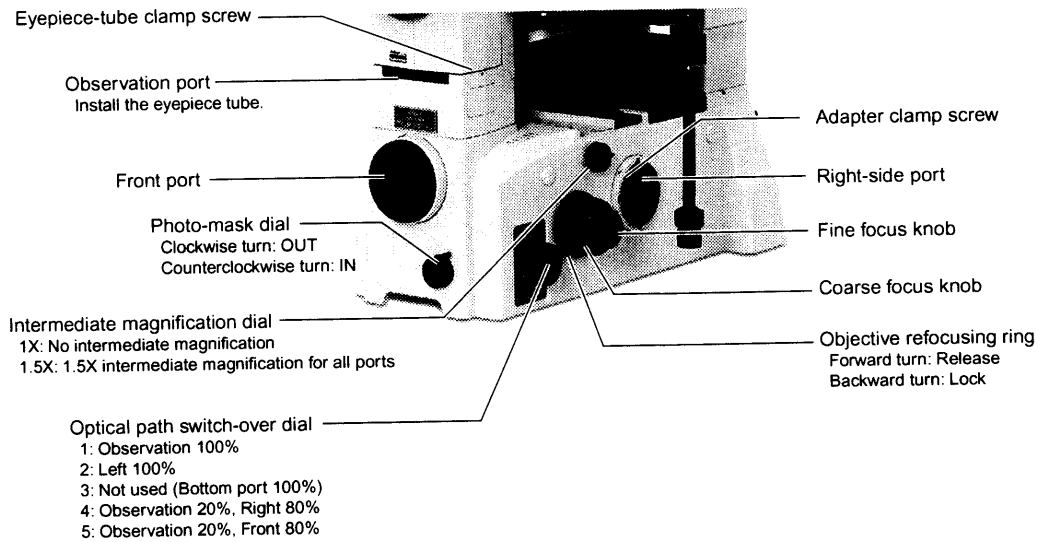

TE2000-U, left side

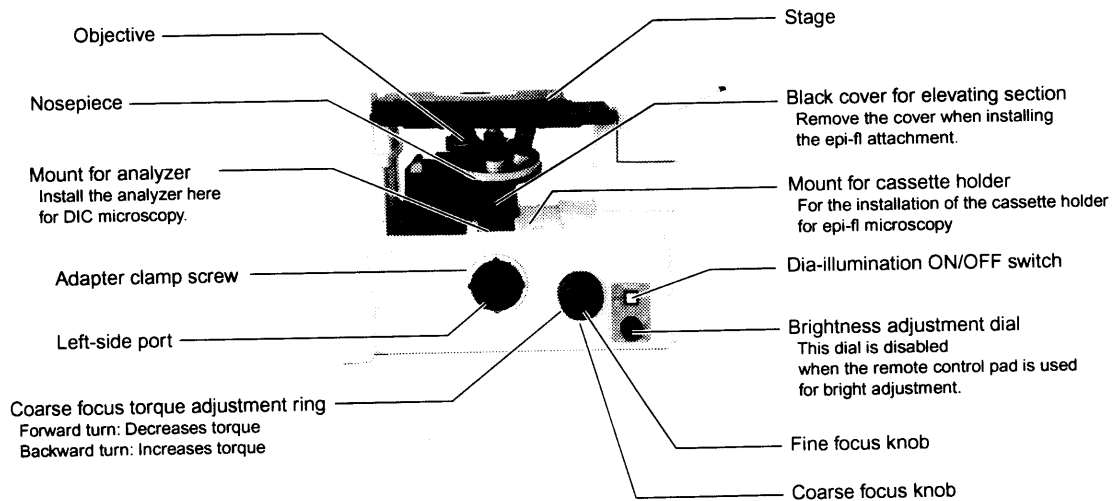

Note: Be sure to cover unused ports with provided caps to prevent the entry of external light and dust.

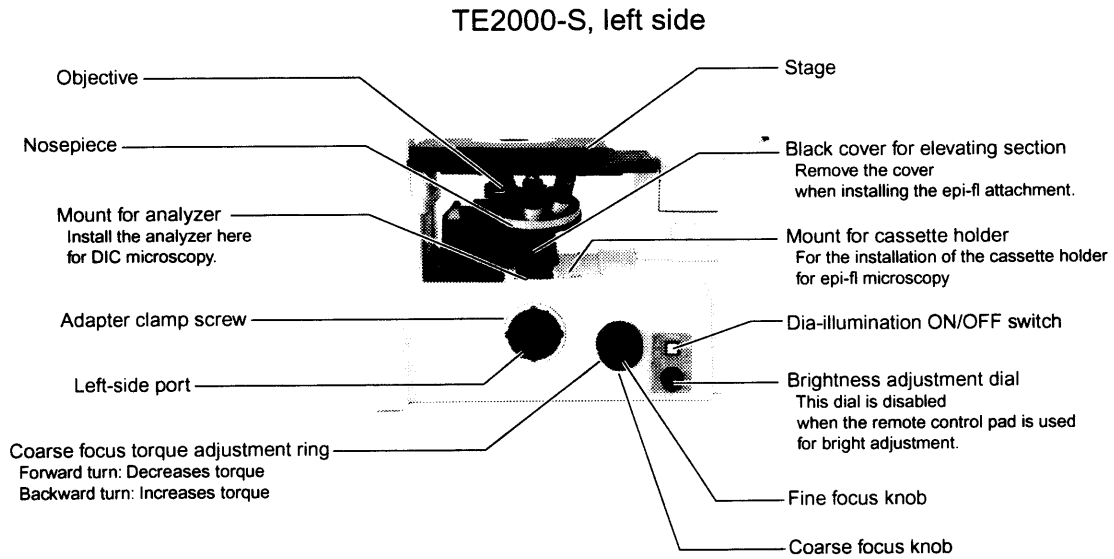
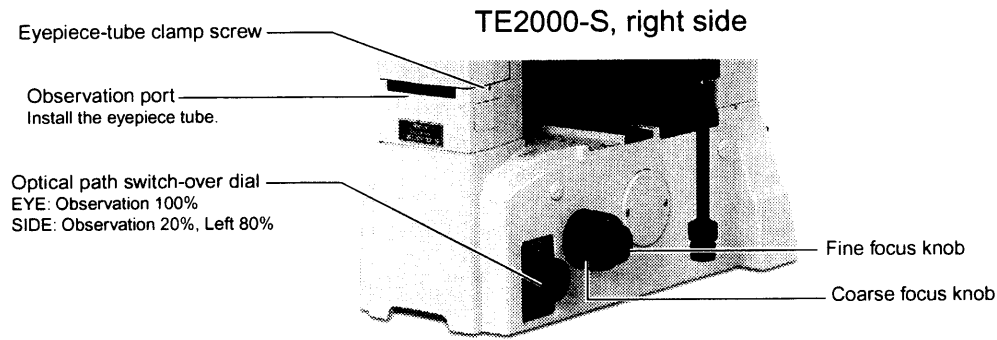

Various adapters for the front port (TE2000-S is not equipped with front port.)

T-BFA F-mount adapter

Digital still camera with F-mount such as D1 can be mounted.

T-BSLR SLR camera adapter

Single-lens reflex camera such as FE10, F70, F90 and F5 can be mounted.

T-BDCA direct C-mount adapter

Digital still camera for the microscopes such as DXM1200, can be mounted here.

Various adapters for side port

Side port adapter

This adapter is supplied with the microscope.

T-BPA photo adapter

Double port adapter

Various TV adapters

Various adapters for bottom port (TE2000-U and TE2000-S are not equipped with bottom port)

Bottom port adapter

This adapter is supplied with the microscope.

Various TV adapters

3. Dia-illuminators

Dia-illuminators should be used in specified pairs with the lamp (12V100W or 6V30W). A lamphouse is needed for the T-DH dia-illuminator 100W.

T-DH dia-illuminator 100W and LHS-H100P-1 12V100W lamphouse

- A: Field aperture diaphragm lever
- B: Filter sliders
- C: Condenser refocusing clamp
(Works only when LWD condenser lens is attached.)
- D: Condenser focus knob
- E: Condenser clamp screw
- F: Condenser mount positioning pin
- G: Condenser mount positioning groove
- H: Condenser mount rotation clamp screw
- I: Condenser centering screw
- J: Condenser mount (rotatable)
- K: LHS-H100P-1 12V100W lamphouse
- L: Lamphouse clamp screw
- M: Lamphouse cover clamp screw
- N: Condenser holder (removable)
- O: Condensr holder clamp screw
- P: Lamp cable
- Q: Condenser holder fall-stop screw

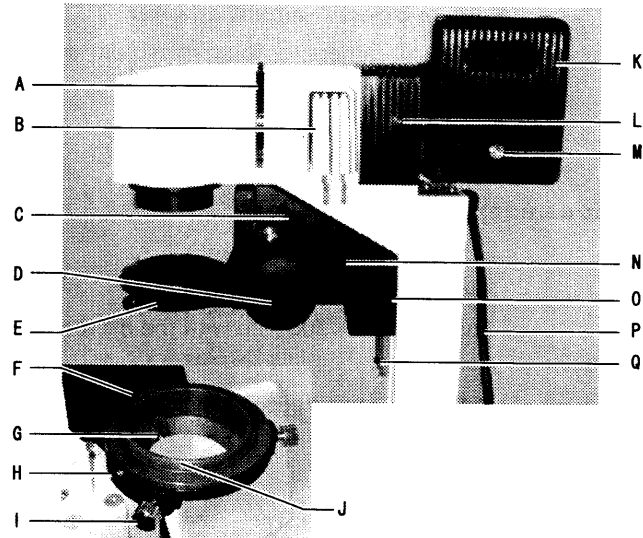

T-DS dia-illuminator 30W

- A: Dustproof slider (removable)
- B: F stop slider (removable)
- C: Condenser mount
- D: 6V30W lamp housing
- E: Filter slider
- F: M4 screw holes for additional device mounting

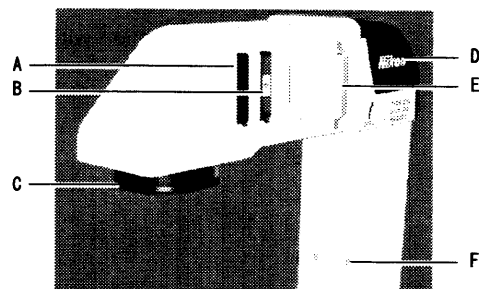

4. Condensers

System condenser

When mounted on
T-DH dia-illuminator 100W

- A: Condenser aperture diaphragm
- B: Condenser module
- C: Condenser module clamp screw
- D: Condenser lens
(3 types available; ELWD, LWD, HMC)
- E: Annular diaphragm centering screw
(on Ph modules only)

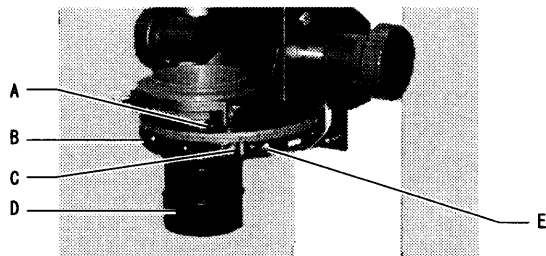

When mounted on T-DS dia-illuminator 30W
(Only for HMC observation.)

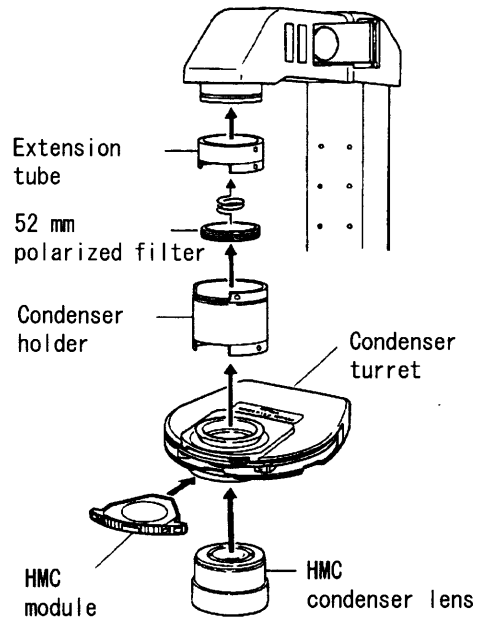

ELWD-S condenser

- A: Centering handle clamp screw
- B: Centering handle
- C: Turret

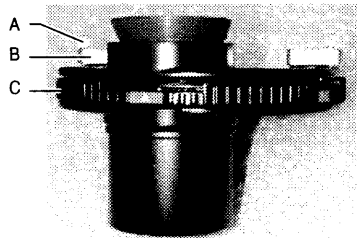

SLWD condenser

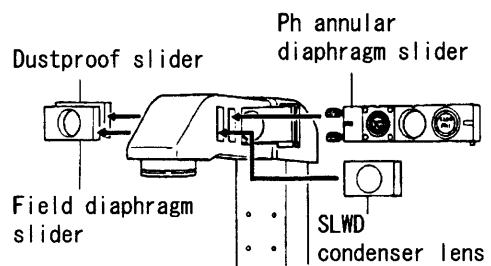

SLWD condenser can only be mounted on
T-DS dia-illuminator 30W.

5. Stages, focusing module

T-SR rectangular stage

- A: Stage ring
- B: Y-axis stage movement knob
- C: X-axis stage movement knob

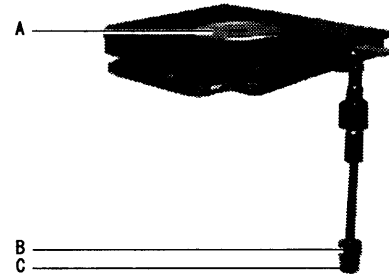

T-SP plain stage

- A: Stage ring

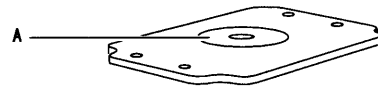

6. Microscope rear

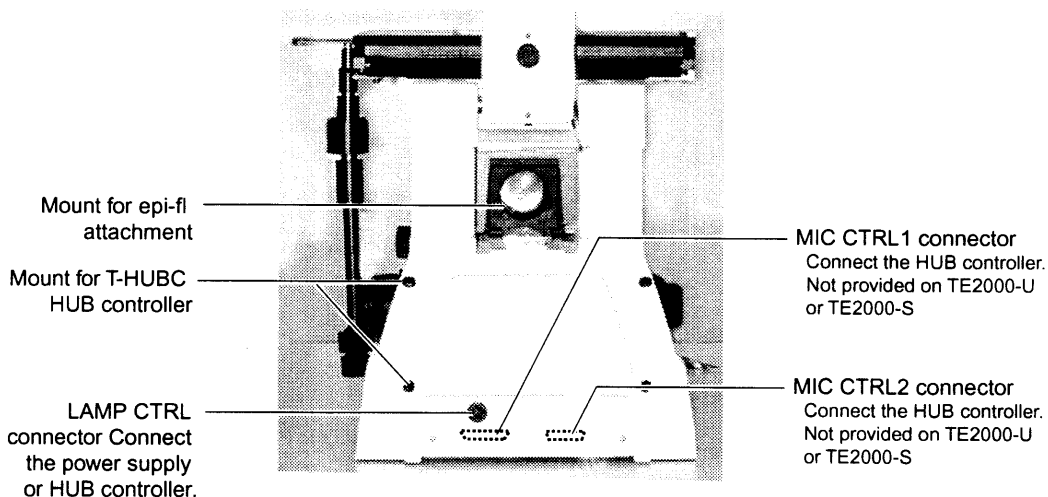

The photo shows the T-HUBC HUB controller and epi-fl attachment installed to the rear side of the microscope. (The HUB controller's connectors are attached with various motorized units.)

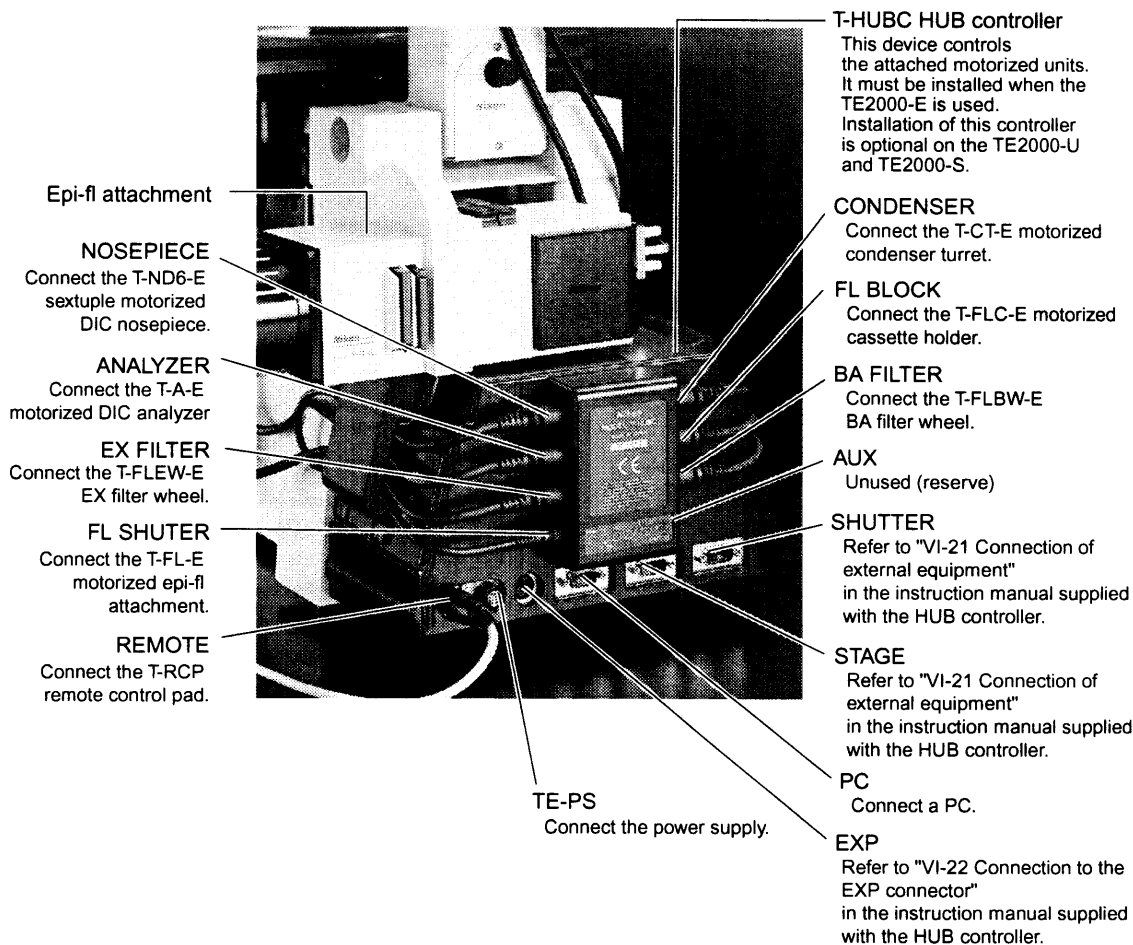

7. Power supplies



WARNING The bottom of the power supply becomes hot while it is in use. Do not obstruct the air vents on the sides of the power supply.

TE2-PS100W power supply

Power switch
Flip the switch to the "I" side to turn on the power; the switch lamp or the pilot lamp should light when the power is on. Flip the switch to the "O" side to turn off the power.

Pilot lamp
Turns on when the power is on.

Brightness adjustment dial
This dial adjusts the lamp brightness when the EXTERNAL switch is off.

AC input connector
Connect the power cord specified in the "Electrical Specifications".

EXTERNAL switch
Turning the switch ON activates the brightness adjustment dial on the microscope or the DIA-LAMP adjustment key on the T-RCP remote control pad (when the T-DH dia-illuminator 100W is used).

Turning this switch OFF activates the brightness adjustment dial on the power supply.

EXTERNAL connector
Connect a control cable between this connector and the LAMP CTRL connector on the rear of the microscope.

OUTPUT connector
This is the lamp output connector. Connect the lamp cable from the dia-illuminator to this connector.

Connector Pin Assignments

OUTPUT connector



Pin 1 : Output +
Pin 2 : Output -
Pin 3 : Unused

Sanwa Electric
SNS-1603-R5Fb

EXTERNAL connector



Pin 1 : Light intensity volume (10k Ω) : Input
Pin 2 : ditto
Pin 3 : Lamp ON/OFF : Input (Open: ON, 0V: OFF)
Pin 4 : 0 V
Pin 5 : Brightness control voltage input : Input
Pin 6 : External control: Output (Open: control disabled, 0V: control enabled)
Pin 7 : 0 V
Pin 8 : Output Monitor : Output

Hirose Electric
HR12-10R-8SC

TE-PS30 power supply (for 100–120 V area) TE-PSE30 power supply (for 220–240 V area)

Power switch
Before turning on the power, confirm that the input voltage shown on the rear panel matches the voltage that you will be using. If not the same, do not use this power supply. Flip the switch to the "I" side to turn on the power; the switch should light when the power is on. Flip the switch to the "O" side to turn off the power.

Input voltage label
Before turning on the power, confirm that the input voltage shown here matches the voltage that you will be using. If not the same, notify your nearest Nikon representative. (If you use the instrument with the wrong input voltage, it may be damaged.)

CTRL switch
Turning this switch ON disables the brightness adjustment dial on the power supply. The brightness adjustment dial on the left side of the microscope can then be used to adjust the brightness. Turning this switch OFF disables the brightness adjustment dial on the microscope. The brightness control dial on the power supply can then be used to adjust the brightness.

Brightness adjustment dial
This dial adjusts the lamp brightness when the CTRL switch is off.

AC input connector
Connect the power cord specified in the "Electrical Specifications".

CTRL connector
Connect the LAMP CTRL connector on the rear of the microscope using a control cable. This device cannot be used to connect the T-HUBC HUB controller.

OUTPUT connector
This is the lamp output connector. Connect the lamp cable from the dia-illuminator to this connector.

Connector Pin Assignments

OUTPUT connector



Output -
Output +

Sato Parts
CN3520J

CTRL connector



Pin 1 : Light intensity volume (10k Ω) : Input
Pin 2 : ditto
Pin 3 : Lamp ON/OFF : Input (Open: ON, 0 V: OFF)
Pin 4 : 0 V
Pin 5 : Unused
Pin 6 : Unused
Pin 7 : Unused
Pin 8 : Unused

Hirose Electric
HR12-10R-8SC

II. Microscopy

When using the TE2000-E



For the microscopy procedure, refer to the instruction manual supplied with the T-HUBC HUB controller.

The T-HUBC HUB controller, which mounts on the rear of the microscope, controls the operations of all attached motorized units. Note that when the T-HUBC HUB controller is mounted on the rear of the microscope, the microscope cannot be operated in the same way as when manual operation is used. Be sure to read the instruction manuals supplied with the T-HUBC HUB controller and T-RCP remote control pad to ensure proper preparation and operation of the microscope.

Note that the following two operations cannot be controlled using the T-HUBC HUB controller.

- 6V30W lamp ON/OFF: Use the dia-illumination ON/OFF switch on the microscope main body.
- 6V30W lamp voltage adjustment: Use the brightness adjustment dial on the microscope main body or power supply.

When using the TE2000-U or TE2000-S
with the T-HUBC HUB controller mounted on the rear



For the microscopy procedure, refer to the instruction manual supplied with the T-HUBC HUB controller.

The T-HUBC HUB controller, which is mounted on the rear of the microscope, controls the operations of all attached motorized units. Note that when the T-HUBC HUB controller is mounted on the rear of the microscope, the microscope cannot be operated in the same way as when manual operation is used. Be sure to read the instruction manuals supplied with the T-HUBC HUB controller and T-RCP remote control pad to ensure proper preparation and operation of the microscope.

Note that the following five operations cannot be controlled using the T-HUBC HUB controller.

- Optical path switchover: Use the optical path switchover dial on the microscope main body.
- Vertical focus motion control from PC: Use the fine/coarse focus knob on the microscope main body.
- Z-axis display: The Z-axis position data cannot be obtained.
- 6V30W lamp ON/OFF: Use the dia-illumination ON/OFF switch on the microscope main body.
- 6V30W lamp voltage adjustment: Use the brightness adjustment dial on the microscope main body or power supply.

The TE2000 series is the system microscopes that can be flexibly configured to meet specific applications. There are three main body types, two types of dia-illuminators, four types of eyepiece tubes, and various other parts variations. The following section describes the basic microscopy procedure based on three standard system configurations.

- Refer to "III. Operation of each part" for details on each operation.
- If your microscope is configured differently from the system described in the manual, refer to the applicable explanations in "III. Operation of each part."
- If your microscope is not pre-assembled, see "IV. Assembly" first.
- If your microscope is mounted with the epi-fl, DIC, or other attachments, refer to the instruction manuals supplied with the respective attachments.

1. Microscope system consisting of TE2000-U, dia-illuminator 100W, system condenser, and T-TD eyepiece tube D

- 1-1. Bright-field microscopy
- 1-2. Phase-contrast microscopy

2. Microscope system consisting of TE2000-S, dia-illuminator 30W, SLWD condenser, and T-TS eyepiece tube S

- 2-1. Bright-field microscopy
- 2-2. Phase-contrast microscopy

3. Microscope system consisting of TE2000-E, dia-illuminator 30W, SLWD condenser, and T-TS eyepiece tube S

- 3-1. Bright-field microscopy
- 3-2. Phase-contrast microscopy

4. Photomicrography (using a 35-mm camera mounted on the front port)

Microscope system consisting of TE2000-U, dia-illuminator 100W, system condenser, and T-TD eyepiece tube D

■ **Supplementary information**

When conducting bright-field or phase-contrast microscopy with a microscope system consisting of the TE2000-E, dia-illuminator 100W, system condenser, and T-TD eyepiece tube D, refer to the instruction manual supplied with the T-HUBC HUB controller since it provides detailed information.



WARNING

Before using the instrument, read the "WARNING," "CAUTION," and "Notes on handling the microscope" sections at the beginning of this manual and be sure to follow the instructions therein.

Also refer to the instruction manuals supplied with other products (such as the epi-fl and DIC attachments) used in combination with the microscope, and follow the instructions written.

1. Microscope system consisting of TE2000-U, dia-illuminator 100W, system condenser, and T-TD eyepiece tube D

The following instructions are based on a microscope equipped with the parts listed below.

TE2000-U microscope
 T-TD eyepiece tube D
 CFI 10X eyepiece
 T-DH dia-illuminator 100W
 LHS-H100P-1 12V100W lamphouse
 12V100W halogen lamp
 TE2-PS100W power supply
 System condenser
 LWD condenser lens
 Condenser module for bright-field microscopy
 Condenser module for phase-contrast microscopy
 T-SR rectangular stage
 T-N6 sextuple nosepiece
 Objectives for bright-field microscopy
 Objectives for phase-contrast microscopy
 Others

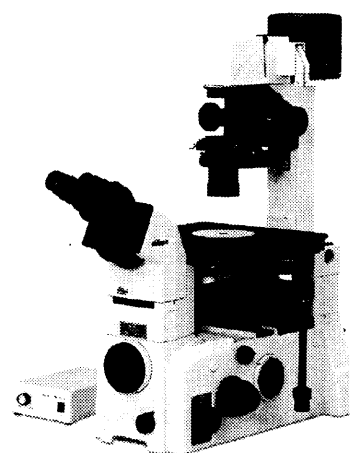

1-1. Bright-field (BF) microscopy

Key point: Detach all optical elements required for other types of observation from the optical path. Position the condenser correctly (adjust the focus and centering), and adjust the clarity of the image by moving the "aperture diaphragm".

1. Reset the convenient functions.

- 1) Turn the "condenser refocusing clamp" on the dia-illuminator counterclockwise to release.
- 2) Set the "eyepiece tube turret" to position < 0 >.
- 3) Set the "intermediate magnification dial" on the right side of the microscope to position < 1X >.
- 4) Turn the "objective refocusing ring" behind the fine/coarse focus knob on the right side of the microscope counterclockwise to release.

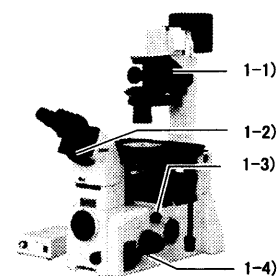

2. Turn on the dia-illumination.

- 1) Set the "EXTERNAL switch" on the rear side of the power supply to ON.
- 2) Turn on the "power switch" of the power supply. (Flip the switch to |.)
- 3) Press the "dia-illumination ON/OFF switch" on the left side of the microscope to turn on the lamp.

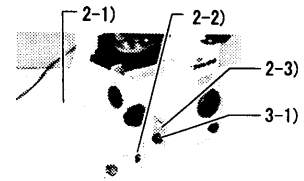

3. Adjust the lamp to ensure color fidelity.

- 1) Set the "brightness adjustment dial" on the left side of the microscope to the < 12V100W > indication.
- 2) Move the "NCB11 filter" on the dia-illuminator into the optical path.
- 3) Move the "ND4 filter" on the dia-illuminator into the optical path.

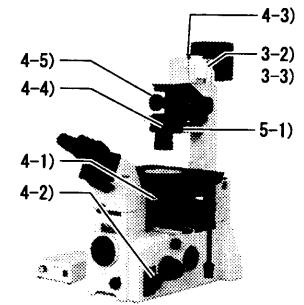

4. Adjust the optical path.

- 1) Move the < 10X > objective into the optical path.
- 2) Set the "optical path switchover dial" on the right side of the microscope to position < 1 >. (-> Direct 100% light to the observation port.)
- 3) Raise the "field diaphragm lever" on the dia-illuminator completely to open the field diaphragm fully.
- 4) Turn the "aperture diaphragm lever" on the system condenser to the right limit to open the "aperture diaphragm" fully.
- 5) Turn the condenser focus knob to lower the condenser mount to the lowest position.

■ Supplementary information

When the system condenser is mounted with the "ELWD condenser lens", position the condenser mount at the location about 1 cm below the uppermost position.

When using the "ELWD-S condenser", position the condenser mount at the location about 2 cm below the uppermost position.

5. Set the microscope for bright-field microscopy.

- 1) Set the "condenser turret" to position < A >.

6. Adjust the diopter and interpupillary distance.

- 1) Turn the "photo-mask dial" on the front side of the microscope counterclockwise to move the photo-mask into the optical path.
- 2) Look into the left eyepiece with your left eye. Turn the "diopter adjustment ring" of the left eyepiece to bring the double crosshairs of the photo-mask into focus.
- 3) Look into the right eyepiece with your right eye. Turn the "diopter adjustment ring" of the right eyepiece to bring the double crosshairs of the photo-mask into focus.

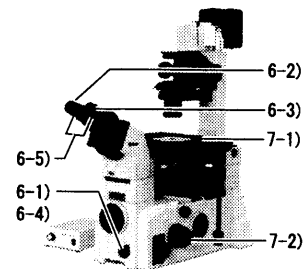

Turn the diopter adjustment ring so that the double crosshairs come into focus.

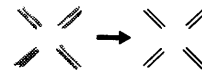

Adjust the interpupillary distance to consolidate the view fields of both eyepieces.

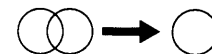

- 4) Turn the "photo-mask dial" on the front side of the microscope clockwise to remove the photo-mask from the optical path.
- 5) Adjust the distance between the eyepieces to consolidate the view fields of both eyepieces.

7. Adjust the focus.

- 1) Place a specimen on the stage.
- 2) While looking into the eyepieces, turn the "fine/coarse focus knob" to bring the specimen into focus.

8. Center the condenser.

- 1) Make sure that the < 10X > objective is in the optical path.
- 2) Lower the "field diaphragm lever" on the dia-illuminator until the field diaphragm image appears in the field of view.
- 3) Turn the "condenser focus knob" to bring the field diaphragm image into focus.
- 4) Turn the two "condenser centering screws" to move the field diaphragm image to the center of the view field.
- 5) Select the < 40X > objective.
- 6) Adjust the position of the "field diaphragm lever" on the dia-illuminator until the size of the field diaphragm image is about the same as that of the view field.
- 7) Turn the two "condenser centering screws" on the dia-illuminator to move the field diaphragm image to the center of the view field.

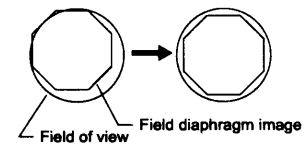
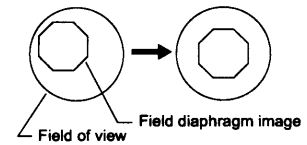
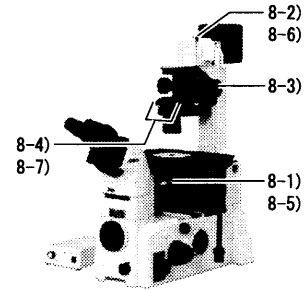

9. Conduct observation.

- 1) Select an objective of desired magnification.
- 2) Move the "aperture diaphragm lever" on the system condenser to set the opening to 70 to 80% of the N.A. (numerical aperture) of the objective. (-> Set the "eyepiece tube turret" to position < B >, turn the Bertrand lens focusing screw to perform focusing, and adjust the size of the image while viewing the exit pupil of objective and aperture diaphragm image.)
- 3) Move the "field diaphragm lever" on the dia-illuminator until the size of the field diaphragm image is about the same as that of the view field.
- 4) Move the "ND filter" on the dia-illuminator in and out of the optical path to adjust the brightness of the view field.

■ Supplementary information

If precise color fidelity is not required, the brightness can be adjusted by varying the lamp voltage using the "brightness adjustment dial" on the left side of the microscope.

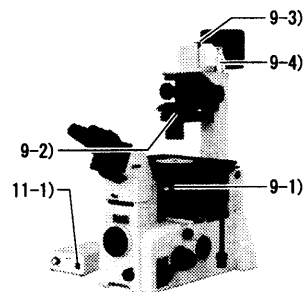

10. Change the specimen.

Use the "objective refocusing ring" on the microscope main body, the "tilting" of the dia-illuminator, and the "condenser refocusing clamp" to facilitate specimen replacement.

11. After the completion of microscopic procedures

- 1) Turn off the "power switch" of the power supply. (Flip the switch to O.)
- 2) After the lamphouse section cools, place the vinyl cover on the microscope.

1-2. Phase-contrast (Ph) microscopy

Key point: Move Ph objective and condenser module with the same Ph code into the optical path, and align (center) the phase plate in the objective and the annular diaphragm in the condenser module before conducting microscopy.

1. Focus on the specimen using bright-field (BF) microscopy.

2. Set the microscope for phase-contrast microscopy.

- 1) Move a Ph objective into the optical path.
- 2) Turn the "condenser turret" and set it to the same Ph code as that of the objective placed in the optical path in step 1).
- 3) Turn the "aperture diaphragm lever" on the condenser to the right limit to open the "aperture diaphragm" fully.

■ Supplementary information

If the "aperture diaphragm" is not fully open, the optical path of the annular diaphragm will be restricted, preventing the realization of the appropriate phase contrast effect.

- 4) Raise the "field diaphragm lever" on the dia-illuminator to the limit to open the field diaphragm fully.

■ Supplementary information

When "ELWD-S condenser" is used:

The "aperture diaphragm" of the "ELWD-S condenser" works only with the bright-field optical path, and it does not affect the phase-contrast optical path. Therefore, there is no need to open the "aperture diaphragm" fully in step 3).

All the annular diaphragms of the "ELWD-S condenser" will be simultaneously centered when the PhL diaphragm is centered. Therefore, move a PhL objective in the optical path, set the "condenser turret" to the "PhL" indication, and proceed to the next step.

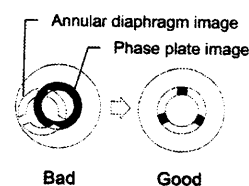
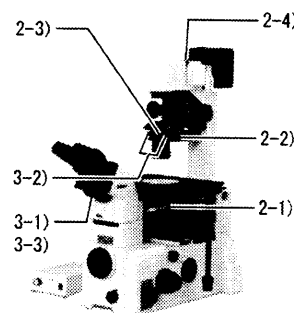

3. Center the annular diaphragm.

- 1) Set the "eyepiece tube turret" to position < B >, and turn the Bertrand lens focusing screw to bring the annular diaphragm image into focus.
- 2) Using a hexagon screwdriver, turn the two "annular diaphragm centering screws" on the condenser module so that the annular diaphragm image coincides with the phase plate image in the objective.
- 3) Return the eyepiece tube turret to position < 0 >.

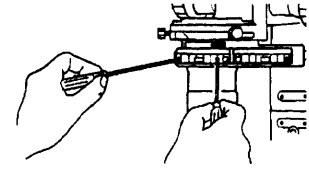
**4. Conduct observation.**

- 1) Fully open the "aperture diaphragm" of the condenser.
- 2) Move the "field diaphragm lever" on the dia-illuminator so that the size of the field diaphragm image is about the same as that of the view field.
- 3) Remove the "NCB11 filter" on the dia-illuminator from the optical path, and move the "GIF filter" into the optical path. (-> To improve the contrast)
- 4) Move the "ND filter" on the dia-illuminator in and out of the optical path to adjust the brightness of the view field.
 - Supplementary information

If precise color fidelity is not required, the brightness can be adjusted by varying the lamp voltage using the "brightness adjustment dial" on the left side of the microscope.

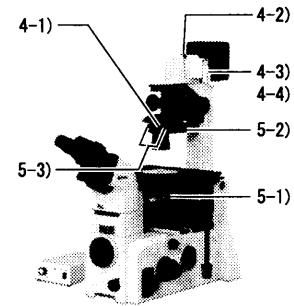
**5. Conduct observations using an objective with a different magnification value.**

- 1) Move a different Ph objective of desired magnification into the optical path.
- 2) Turn the "condenser turret" and set it to the same Ph code as that of the objective placed in the optical path in step 1).
- 3) Center the annular diaphragm placed in the optical path. (-> See the procedure 3.)
 - Supplementary information

When the system condenser is installed with the Ph condenser module, it is necessary to center all Ph modules.

When the "ELWD-S condenser" is used, centering the PhL diaphragm results in the centering of all annular diaphragms.

6. Change the specimen.

Use the "objective refocusing ring" on the microscope main body, the "tilting" of the dia-illuminator, and the "condenser refocusing clamp" to facilitate specimen replacement.

7. Upon the completion of microscopy

Follow the same procedure as for bright-field (BF) microscopy.

2. Microscope system consisting of TE2000-S, dia-illuminator 30W, SLWD condenser, and T-TS eyepiece tube S

The following instructions are based on a microscope equipped with the parts listed below.

TE2000-S microscope
 T-TS eyepiece tube S
 CFI 10X eyepiece
 T-DS dia-illuminator 30W
 6V30W halogen lamp
 TE-PS30 power supply
 SLWD condenser
 T-SR rectangular stage
 T-N6 sextuple nosepiece
 Objectives for bright-field microscopy
 Objectives for phase-contrast microscopy
 Others

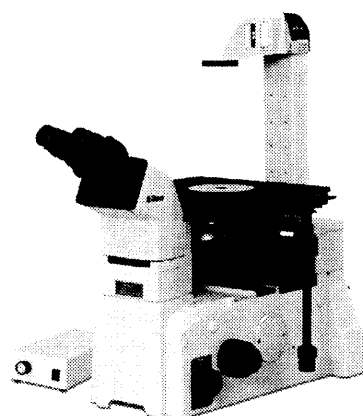

2-1. Bright-field (BF) microscopy

Key point: Detach all optical elements required for other types of observation from the optical path. The size of the field diaphragm of the SLWD condenser is fixed. There is no "aperture diaphragm".

1. Turn on the dia-illumination.

- 1) Make sure that the input voltage indication on the rear side of the power supply corresponds with the voltage of the commercial power source in the area. (-> If different, do not turn on the switch. Contact your nearest Nikon representative immediately.)
- 2) Turn on the "CTRL switch" on the rear side of the power supply.
- 3) Turn on the "power switch" of the power supply. (Flip the switch to |.)
- 4) Press the "dia-illumination ON/OFF switch" on the left side of the microscope to turn on the lamp.

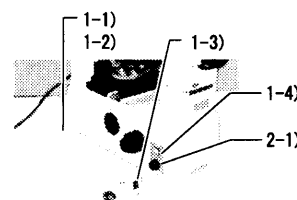

2. Adjust the lamp to ensure color fidelity.

- 1) Set the "brightness adjustment dial" on the left side of the microscope to the < 6V30W > indication.
- 2) Move the "NCB11 filter" on the dia-illuminator into the optical path.
- 3) Move the "ND4 filter" on the dia-illuminator into the optical path.

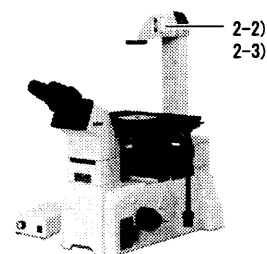

3. Adjust the optical path.

- 1) Move the < 10X > objective into the optical path.
- 2) Set the "optical path switchover dial" on the right side of the microscope to position < EYE >. (-> Direct 100% of the light to the observation port.)
- 3) Place a specimen on the stage.

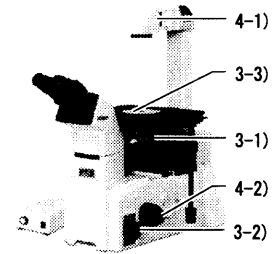
**4. Set the microscope for bright-field microscopy.**

- 1) Slide the Ph annular diaphragm slider to move the < Open > position into the optical path.
- 2) While looking into the eyepieces, turn the fine/coarse focus knob to bring the specimen into focus.

5. Adjust the diopter and interpupillary distance.

- 1) Turn the "diopter adjustment rings" of both right and left eyepieces so that the engraved line of each diopter adjustment ring aligns with the outer ring rim of the eyepiece. (This sets the diopter adjustment to the "0" position.)
- 2) Move the < 40X > objective into the optical path.
- 3) While looking into the left eyepiece with your left eye, turn the "fine/coarse focus knob" of the microscope to bring the specimen into focus.
- 4) Move the < 10X > objective into the optical path.
- 5) While looking into the left eyepiece with your left eye, turn the "diopter adjustment ring" of the left eyepiece to bring the specimen into focus. (Do not touch the fine/coarse focus knob on the microscope main body in this step.)
- 6) Repeat steps 2) through 5) two more times.
- 7) Adjust the right side by following the same procedure. (Substitute "right" for "left" in steps 2) through 5), and repeat these steps three times.)
- 8) Adjust the interpupillary distance to consolidate the view fields of both eyepieces.

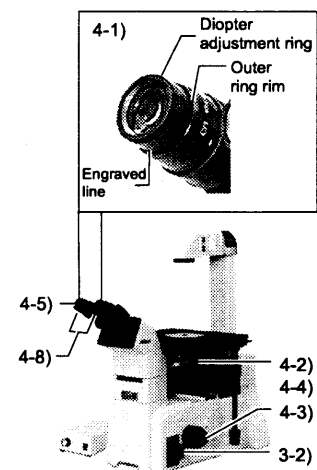
**6. Conduct observation.**

- 1) Select an objective of desired magnification.
- 2) Move the "ND filter" on the dia-illuminator in and out of the optical path to adjust the brightness of the view field.
 - Supplementary information

If precise color fidelity is not required, the brightness can be adjusted by varying the lamp voltage using the "brightness adjustment dial" on the left side of the microscope.

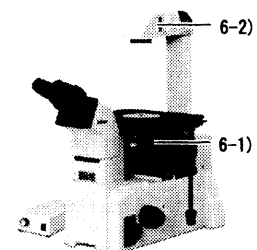
**7. Upon the completion of microscopy**

- 1) Turn off the power switch of the power supply. (Flip the switch to O.)
- 2) After the lamp mounting section cools, place the vinyl cover on the microscope.

2-2. Phase-contrast (Ph) microscopy

Key point: Slide the Ph annular diaphragm slider to move the annular diaphragm with the same Ph code as the objective into the optical path, then conduct microscopy. Note that the PhL diaphragm must be centered.

1. Focus on the specimen using bright-field microscopy.

2. Set the microscope for phase-contrast microscopy.

- 1) Move a Ph objective into the optical path.
- 2) Slide the Ph annular diaphragm slider to move the annular diaphragm < with the same Ph code > as the objective placed in the optical path in step 1) into the optical path.

3. Center the PhL diaphragm.

- 1) Move the < PhL > objective into the optical path.
- 2) Slide the Ph annular diaphragm slider to move the < PhL > diaphragm into the optical path.
- 3) Remove one eyepiece, and insert the centering telescope using the adapter.
- 4) Turn the eyepiece of the "centering telescope" to bring the annular diaphragm image into focus.
- 5) Turn the two "annular diaphragm centering screws" on the condenser so that the annular diaphragm image coincides with the phase plate image in the objective.
- 6) Reinstall the eyepiece to the original position.

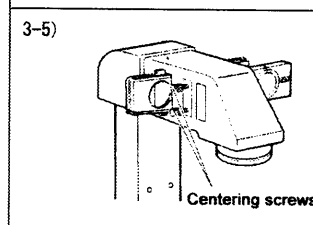
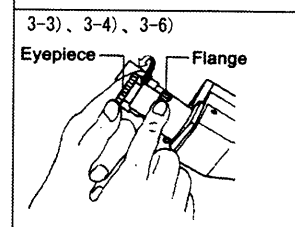
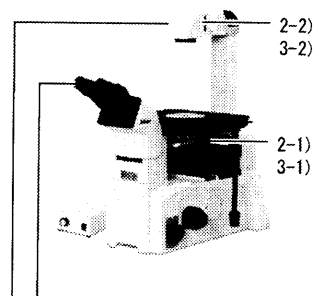

4. Conduct observation.

- 1) Remove the "NCB11 filter" on the dia-illuminator from the optical path, and move the "GIF filter" into the optical path. (-> To improve the contrast)
- 2) Move the "ND filter" on the dia-illuminator in and out of the optical path to adjust the brightness of the view field.

■ Supplementary information

If precise color fidelity is not required, the brightness can be adjusted by varying the lamp voltage using the "brightness adjustment dial" on the left side of the microscope.

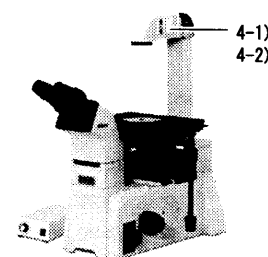

5. Conduct observations using an objective with a different magnification value.

- 1) Move a different Ph objective of desired magnification into the optical path.
- 2) Slide the Ph annular diaphragm slider to set to the same Ph code as that of the objective placed in the optical path in step 1).

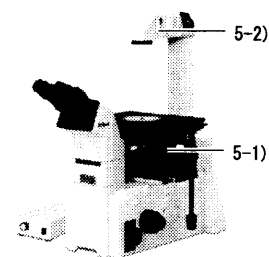

6. Upon the completion of microscopy

Follow the same procedure as for bright-field (BF) microscopy.

3. Microscope system consisting of TE2000-E, dia-illuminator 30W, SLWD condenser, and T-TS eyepiece tube S

The following instructions are based on a microscope equipped with the parts listed below.

- TE2000-E microscope
- T-HUBC HUB controller
- AC adapter
- Power cord for AC adapter
- T-RCP remote control pad
- T-TS eyepiece tube S
- CFI 10X eyepiece
- T-DS dia-illuminator 30W
- 6V30W halogen lamp
- TE-PS30 power supply
- SLWD condenser
- T-SR rectangular stage
- T-N6 sextuple nosepiece
- Objectives for bright-field microscopy
- Objectives for phase-contrast microscopy
- Others

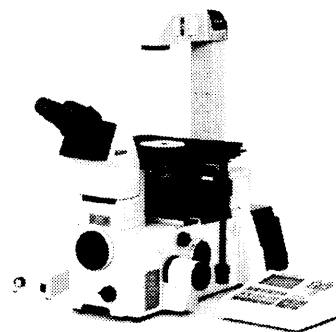

3-1. Bright-field (BF) microscopy

Key point: Detach all optical elements required for other types of observation from the optical path. The size of the field diaphragm of the SLWD condenser is fixed. There is no aperture diaphragm. Since the 6V30W lamp ON/OFF and lamp voltage adjustment cannot be controlled using the T-RCP remote control pad, use the switch and control on the microscope main body.

1. Turn on the dia-illumination.

- 1) Make sure that the input voltage indication on the rear side of the power supply corresponds with the voltage of the commercial power source in the area. (-> If different, do not turn on the switch. Contact your nearest Nikon representative immediately.)
- 2) Turn on the "CTRL switch" on the rear side of the power supply.
- 3) Turn on the "power switch" of the power supply. (Flip the switch to |.)
- 4) Turn on the "power switch" of the HUB controller. (Flip the switch to |.)
- 5) Press the dia-illumination ON/OFF switch on the left side of the microscope to turn on the lamp.

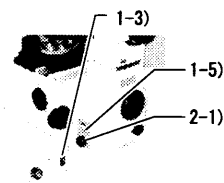
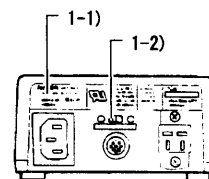

2. Adjust the lamp to ensure color fidelity.

- 1) Set the "brightness adjustment dial" on the left side of the microscope to the < 6V30W > indication.
- 2) Move the "NCB11 filter" on the dia-illuminator into the optical path.
- 3) Move the "ND4 filter" on the dia-illuminator into the optical path.

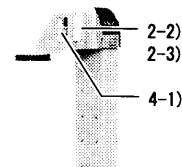

3. Adjust the optical path.

- 1) Press the "OBJECTIVE" key on the remote control pad to move the < 10X > objective into the optical path.
- 2) Press the "LIGHT PATH" key on the remote control pad to point 100% light toward the observation port.
- 3) Place a specimen on the stage.

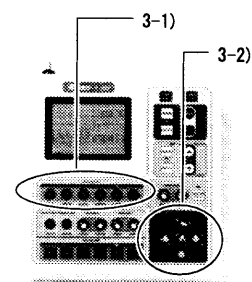

4. Set the microscope for bright-field microscopy.

- 1) Slide the Ph annular diaphragm slider to move the < Open > position into the optical path.
- 2) While looking into the eyepieces, turn the "fine/coarse focus knob" to bring the specimen into focus.

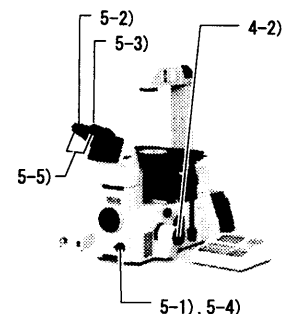

5. Adjust the diopter and distance between the eyepieces.

- 1) Turn the "photo-mask dial" on the front side of the microscope counterclockwise to move the photo-mask into the optical path.
- 2) Look into the left eyepiece with your left eye. Turn the "diopter adjustment ring" of the left eyepiece to bring the double crosshairs of the photo-mask into focus.
- 3) Look into the right eyepiece with your right eye. Turn the "diopter adjustment ring" of the right eyepiece to bring the double crosshairs of the photo-mask into focus.
- 4) Turn the "photo-mask dial" on the front side of the microscope clockwise to remove the photo-mask from the optical path.
- 5) Adjust the interpupillary distance to consolidate the view fields of both eyepieces.

Turn the diopter adjustment ring so that the double crosshairs come into focus.

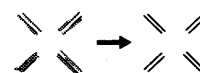

Adjust the interpupillary distance to consolidate the view fields of both eyepieces.

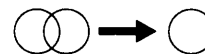

6. Conduct observation.

- 1) Press the "OBJECTIVE" key on the remote control pad to select the desired magnification.
- 2) Move the ND filter on the dia-illuminator in and out of the optical path to adjust the brightness of the view field.

■ Supplementary information

If precise color fidelity is not required, brightness can be adjusted by varying the lamp voltage using the "brightness adjustment dial" on the left side of the microscope.

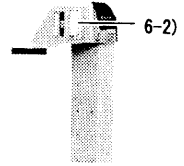

7. Upon the completion of microscopy

- 1) Turn off the power switch of the HUB controller. (Flip the switch to O.)
- 2) Turn off the power switch of the power supply. (Flip the switch to O.)
- 3) After the lamp mounting section cools, place the vinyl cover on the microscope.

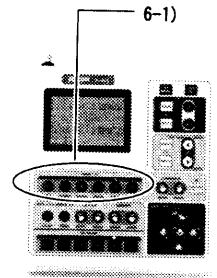

3-2. Phase-contrast (Ph) microscopy

Key point: Slide the Ph annular diaphragm slider to move the annular diaphragm with the same Ph code as the objective into the optical path, then conduct microscopy. Note that the PhL diaphragm must be centered.

1. Focus on the specimen using bright-field microscopy.

2. Set the microscope for phase-contrast microscopy.

- 1) Press the "OBJECTIVE" key on the remote control pad to move a Ph objective into the optical path.
- 2) Slide the Ph annular diaphragm slider to move the annular diaphragm < with the same Ph code > as the objective placed in the optical path in step 1) into the optical path.

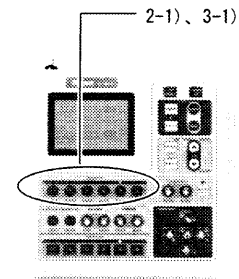

3. Center the PhL diaphragm.

- 1) Press the "OBJECTIVE" key on the remote control pad to move a PhL objective into the optical path.
- 2) Slide the Ph annular diaphragm slider to move the < PhL > diaphragm into the optical path.
- 3) Remove one eyepiece, and insert the "centering telescope" using the adapter.
- 4) Turn the eyepiece of the "centering telescope" to bring the annular diaphragm image into focus.
- 5) Turn the two "annular diaphragm centering screws" on the condenser so that the annular diaphragm image coincides with the phase plate image in the objective.
- 6) Return the eyepiece to the original position.

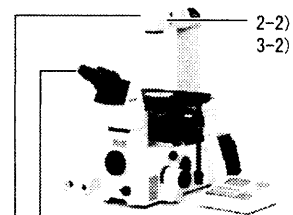

4. Conduct observation.

- 1) Remove the "NCB11 filter" on the dia-illuminator from the optical path, and move the "GIF filter" into the optical path. (-> To improve the contrast)
- 2) Move the "ND filter" on the dia-illuminator in and out of the optical path to adjust the brightness of the view field.
 - Supplementary information
 - If precise color fidelity is not required, the brightness can be adjusted by varying the lamp voltage using the "brightness adjustment dial" on the left side of the microscope.

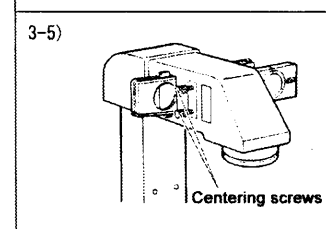
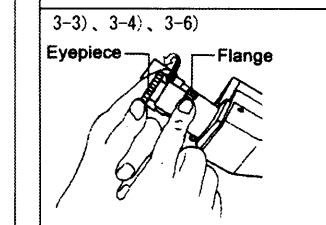

5. Conduct observations using an objective with a different magnification value.

- 1) Press the "OBJECTIVE" key on the remote control pad to move a different Ph objective of desired magnification into the optical path.
- 2) Slide the Ph annular diaphragm slider to set to < the same Ph code > as that of the objective placed in the optical path in step 1).

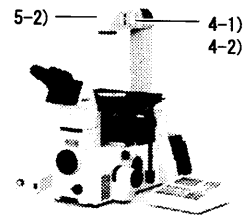

6. Upon the completion of microscopy

Follow the same procedure as for bright-field (BF) microscopy.

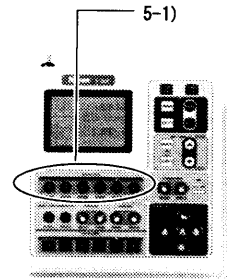

4. Photomicrography (using a 35-mm camera mounted on the front port)

The following describes the procedure for taking pictures with a daylight-type color film using a single-lens reflex camera attached to the front port of the microscope. Regarding the operation of the camera, refer to the instruction manual supplied with the camera. Load the camera with film before starting the following steps. Also refer to "14. Photomicrography" in "III. Operation of each part."

The following instructions are based on a microscope equipped with the parts listed below.

TE2000-U microscope
 T-TD eyepiece tube D
 CFI 10X eyepiece
 T-DH dia-illuminator 100W
 LHS-H100P-1 12V100W lamphouse
 12V100W halogen lamp
 TE2-PS100W power supply
 System condenser
 LWD condenser lens
 Condenser module for bright-field microscopy
 Condenser module for phase-contrast microscopy
 T-SR rectangular stage
 T-N6 sextuple nosepiece
 Objectives for bright-field microscopy
 Objectives for phase-contrast microscopy
 Others

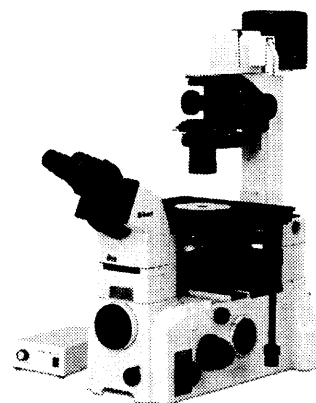

1. **Focus on the specimen using bright-field (BF) microscopy.**
2. **Set up the 35-mm camera.**
 - 1) Mount the 35-mm camera on the front port.
 - 2) Set the "exposure mode" of the camera to < Aperture Priority Auto Mode >.
 - 3) Set the "exposure compensation" of the camera to < +2/3 >. (-> Slight overexposure produces better results when using a 35-mm film camera mounted on the front port.)
 - 4) Adjust the other settings (ISO value, photometry mode, etc.) on the camera.

3. Adjust the lamp for color fidelity.

- 1) Set the "brightness adjustment dial" on the left side of the microscope to the < 12V100W > indication.
- 2) Move the "NCB11 filter" on the dia-illuminator into the optical path.
- 3) Move the "ND4 filter" on the dia-illuminator into the optical path.

■ Supplementary information

If precise color fidelity is not required, such as when monochromic film is used, the "brightness adjustment dial" on the left side of the microscope can be set to any position.

In the case of the "T-DS dia-illuminator 30W", setting the brightness adjustment dial to < 6V30W > and moving the "NCB11 filter" into the optical path results in optimum color fidelity.

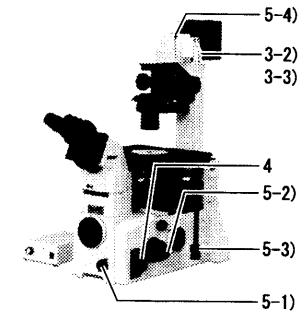

4. Point the optical path toward the camera.

Set the "optical path switchover dial" on the right side of the microscope to position < 5 >. (-> 20% light to the observation port and 80% light to the front port)

■ Supplementary information

When the photographing device is attached to any port other than the front port, distribute light to that port.

5. Decide on the picture composition and focus on the film surface.

- 1) Turn the "photo-mask dial" on the front side of the microscope counterclockwise to move the photo-mask into the optical path.
- 2) Turn the "fine/coarse focus knob" on the microscope to bring the specimen into focus.

■ Supplementary information

Setting the "eyepiece tube turret" to position < M > facilitates the focusing process. Take care not to touch the "diopter adjustment ring" of the eyepiece in this step.

- 3) Adjust the position of the specimen so that the target area is located within the photo frame.
- 4) Move the "field diaphragm lever" on the dia-illuminator so that the field diaphragm image is slightly larger than the photo frame.

■ Supplementary information

The TE2000-S is not equipped with a photo-mask. Look into the finder of the photographing device to confirm the photographing range and focus. Installation of the optional "mask eyepiece" enables you to see the approximate photographing range and focus on the film using the eyepiece.

Photo frame on photo-mask

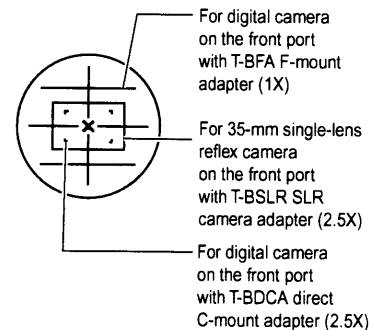

View field of the mask eyepiece

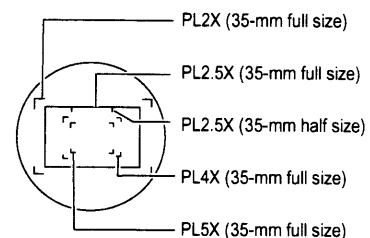

6. Adjust the brightness.

- 1) Move the "aperture diaphragm lever" on the condenser to adjust the image contrast, depth of focus, and resolution.
- 2) Check the camera exposure time.
 - Longer than $< 1/8 \text{ s} >$ -> Acceptable
 - $< 1/8 \text{ s} >$ or shorter -> Move the "ND filter" on the diaphragm in and out of the optical path to set the exposure time to longer than $< 1/8 \text{ s} >$. (-> To minimize the effect of vibration caused by shutter operation)
 - Supplementary information
 - If precise color fidelity is not required, such as when monochromic film is used, the brightness may be reduced by using the "brightness adjustment dial" on the left side of the microscope.

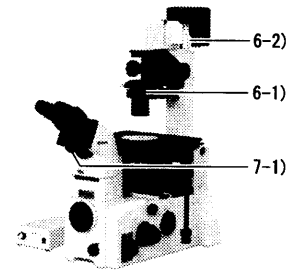

7. Prevent the entry of extraneous light.

- 1) Set the "eyepiece tube turret" to position $< C >$.
- 2) Install the finder cap to the camera finder or cover the finder with a cloth.
 - Supplementary information
 - If an eyepiece tube turret is not included, place a cloth on the eyepieces to prevent the entry of extraneous light.

8. Press the shutter.



Using a remote release or self-timer of the camera eliminates the effect of vibration caused by shutter operation.

III. Operation of each part

In this chapter, operation of each part is described.

- Refer to "II. Microscopy" for the procedures on microscopy.
- If your microscope is not assembled yet, see "IV. Assembly" first.
- If you have mounted the Epi-fl or DIC attachment on the microscope, also refer to the instruction manual supplied with the attachments.
- Also refer to "I. Parts of the microscope and their names" for simple description of each part.
- **If you are using the TE2000-E model, read the instruction manual supplied with the T-HUBC HUB controller.**
- **When the T-HUBC HUB controller is mounted on the rear side of the microscope, read the instruction manual supplied with the HUB controller.**

WARNING

Before using the instrument, read the " **WARNING**", " **CAUTION**" and "Notes on handling the microscope" at the beginning of this manual and be sure to follow the warnings and cautions written therein.

Also refer to the instruction manual supplied with the other instruments used together with the microscope (such as Epi-fl or DIC attachments) and be sure to follow the warnings and cautions written therein.

1. Power ON / OFF

Combination of the lamp, dia-illuminator and power supply

The combination of the dia-illuminator and the power supply is fixed against the ratings of the lamp to be used (either 12V100W or 6V30W). See the chart below to check the correct combination of the lamp, dia-illuminator and the power supply.

No other combination can be used.

To control the lamp ON/OFF and lamp voltage adjustment from the remote control pad or PC via the T-HUBC HUB controller, be sure to use the 12V100W lamp. The 6V30W lamp cannot be controlled using the remote control pad or PC.

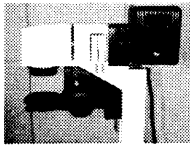
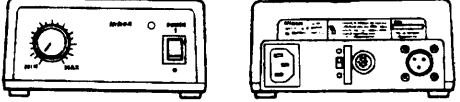
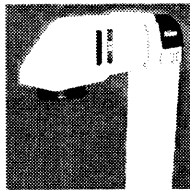
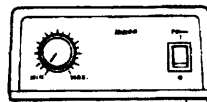
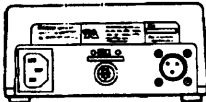
Microscope	Ratings of the lamp	Dia-illuminator	Power supply	
			On 100-120V areas	On 220-240V areas
TE2000-E TE2000-U TE2000-S	12V100W Halogen lamp (OSRAM HLX 64623 or PHILIPS 7724I)	T-DH 100W (LHS-H100P-1 12V100W lamphouse is needed) 	TE2-PS100W (For 100-240V areas) 	
	6V30W Halogen lamp (PHILIPS 5761)	T-DS 30W 	TE-PS30 (For 100-120V areas) 	TE-PSE30 (For 230V areas) 

The remote control pad and PC cannot be used to control the lamp ON/OFF and lamp voltage adjustment.

Power ON / OFF

There is a "power switch" at the front of the power supply. Pressing the switch to " | side" will turn ON the power. The pilot lamp lights to show the power ON status. (If TE-PS30 or TE-PSE30 power supply is used, the power switch itself lights instead of a pilot lamp.) Dia-illumination can now be turned on and off by the Dia-illumination ON / OFF switch on the side of the microscope.

Pressing the power switch to "O side" will turn OFF the lamp and the pilot lamp (or the switch itself).

*** When the T-HUBC HUB controller is mounted on the rear side of the microscope, be sure to read the instruction manual supplied with the HUB controller.**

Power switch
|: On, O:Off

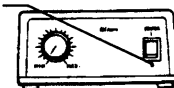

Dia-illumination ON / OFF switch

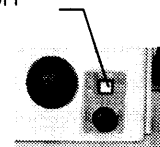

2. Brightness adjustment

Brightness can be adjusted by ND filters (dimming filters) and/or the brightness adjustment dial.

Adjustment with ND filters

Filters that control light quantity are called ND filters. An ND filter with a large number allows less light to pass and therefore produces a darker image.

Since the ND filters will not change the tint (color temperature) of the light source, they can be useful when color reproducibility is of concern (such as when taking pictures using day-light type color film.)

ND filters are to be set on the filter holders on the dia-illuminator.

ND2: Reduces light quantity to 1/2

ND16: Reduces light quantity to 1/16

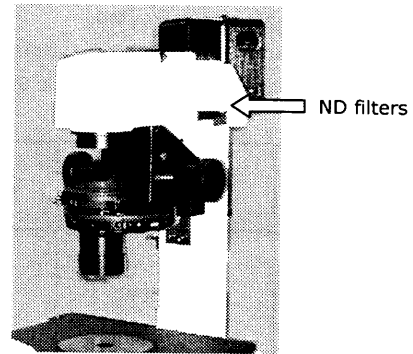

Adjustment with brightness adjustment dial

There are two brightness adjustment dials: one on the front of the power supply and the other on the left side of the microscope base. Turning the dial changes the voltage supplied to the lamp, which changes the brightness and the hue of the illumination.

To make the illumination bright, turn the dial to larger number which results in giving the bluish hue to the illumination. To make the illumination dark, turn the dial to smaller number which results in giving the reddish hue to the illumination.

On normal use, set the dial between 6 to 12.

If the color reproducibility is of concern (such as when taking pictures using day-light type color film), set the dial to the same indication as the ratings of the lamp and place the NCB11 filter in the optical path. The illumination will then become most similar to the white light. (*1)

Two dials cannot be used simultaneously. Select which dial is to be used with the "EXTERNAL switch (or CTRL switch)" on the rear of the power supply. (*2)(*3)

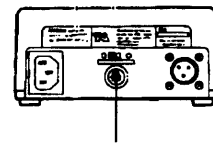

EXTERNAL switch (CTRL switch)

*1: In this case, brightness adjustment should be performed with ND filters.

*2: "EXTERNAL switch" is for TE2-PS100W power supply.

"CTRL switch" is for TE-PS30 or TE-PSE30 power supply.

*3: Note that the actual brightness differs slightly between the same numbers on the brightness adjustment dial of the power supply and the brightness adjustment dial of the microscope.

- When the TE2-PS100W power supply is connected to the T-HUBC HUB controller, be sure to refer to the instruction manual supplied with the HUB controller.

Set to ON to use the brightness adjustment dial on the microscope.

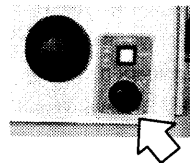

Set to OFF to use the brightness adjustment dial on the power supply.

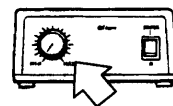

3. Optical path switching

Use the "optical path switchover dial" to send the image to each port. (See page 49 for the type of the photomicrography equipment that each port can accept.)

For TE2000-E

Connect the T-RCP remote control pad or PC to the T-HUBC HUB controller for the switching of the optical path. For details, refer to the instruction manual supplied with the T-HUBC HUB controller.

When using the T-RCP remote control pad

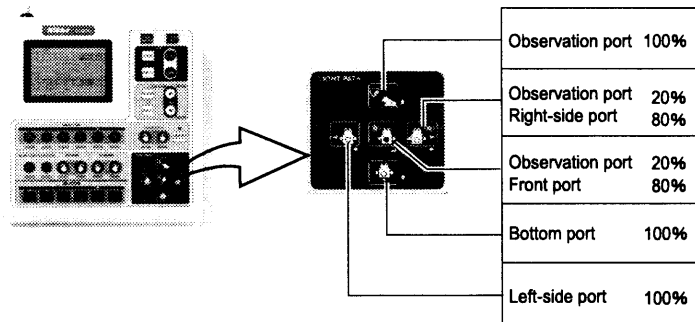

The LED above the selected key lights.

For TE2000-U

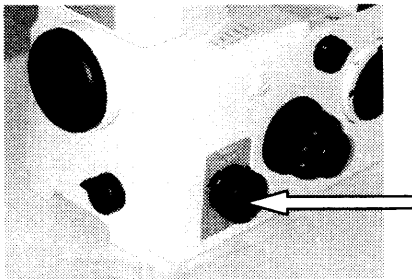

*1: Dial position "3" cannot be used on normal microscope models; however, an optional prism such as "front port 100%" and "right-side port 100%" can be installed.

Position of optical path switchover dial	Light distribution(%)			
	Observation port	Front port	Right-side port	Left-side port
1	100	-	-	-
2	-	-	-	100
3 (*1)	-	-	-	-
4	20	-	80	-
5	20	80	-	-
Equipment that can be attached to the port	Eyepiece tube Intermediate Tube + trinocular eyepiece tube (+ various equipment)	SLR camera F-mount digital camera	Photomicrography equipment for microscopes Digital camera TV camera	Photomicrography equipment for microscopes Digital camera TV camera

For TE2000-S

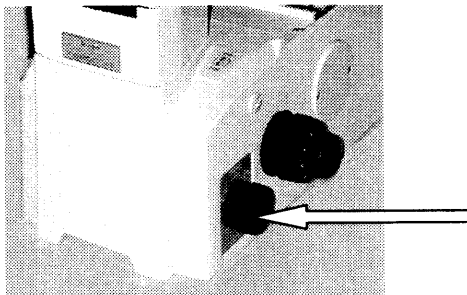

Position of optical path switchover dial	Light distribution(%)	
	Observation port	Left-side port
SIDE	20	80
EYE	100	-
Equipment that can be attached to the port	Eyepiece tube Intermediate tube + trinocular eyepiece tube (+ various equipment)	TV camera

4. Using filters

Set the appropriate filters on four filter sliders of the dia-illuminator. The following filters are available.

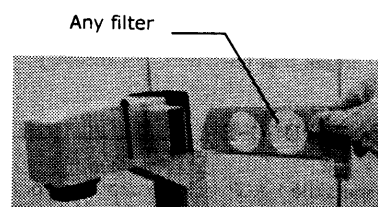

Filter	Description
ND2	For brightness adjustment in normal microscopy and photomicrography. Reduces light quantity to 1/2. (Approx. 50% transmissivity.)
ND16	For brightness adjustment in normal microscopy and photomicrography. Reduces light quantity to 1/16. (Approx. 6% transmissivity.)
NCB11	For correcting the color temperature in normal microscopy and color photomicrography using day-light type color film. (Should be removed on monochrome photomicrography.) Color reproduction is optimized when this filter is set in the optical path and the brightness adjustment dial is turned to the indication same as the ratings of the lamp.
GIF	Green interference filter. For microscopy using monochromatic light and for improving the contrast in monochrome photomicrography.
HA	Heat absorption filter. For reducing the influence of heat rays in the illumination against specimen. Though the dia-illuminator has a built-in heat absorption filter, set this filter in the optical path if your specimen is very sensitive to heat.

5. Using field diaphragm

The field diaphragm restricts the illumination on a specimen to an observed area. Raising the field diaphragm lever to its uppermost position will maximize the diameter of the diaphragm. (*1)

For general use, the diaphragm should be set slightly larger than the view field. Too wide an illuminated area gives off stray light, which causes flares, resulting in reduced image contrast. Therefore, for photomicrography in particular, correct adjustment is very important. The best results can be obtained by stopping down the diaphragm so that it is slightly wider than the area to be imaged on the film (such as the frame on the photo-mask). (Note that stopping down the diaphragm too far causes vignetting.)

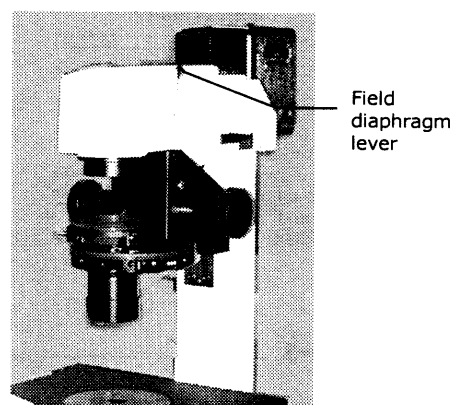

*1: The size of the field aperture diaphragm on "T-DS dia-illuminator 30W" is fixed and cannot be changed.

6. Using condenser aperture diaphragm

The condenser aperture diaphragm adjusts the numerical aperture (N.A.) of the illumination system. Aperture of this diaphragm determines optical resolution, brightness, contrast, and depth of focus. Narrowing down the condenser aperture diaphragm decreases resolution and brightness, and increases contrast and depth of focus. Because these characteristics are interrelated and cannot be controlled one by one, the aperture must be adjusted for each specimen and application.

Adjustment of the condenser aperture diaphragm is especially important for bright-field microscopy, DIC microscopy, and photomicrography. Generally, aperture settings of 70 to 80% of the objective N.A. yield good images of appropriate contrast. Adjust the aperture while observing the diaphragm image. Moving the lever to the left stops down the diaphragm. Moving the lever to the right opens it. Adjust so that the diaphragm reaches 70 to 80% of the exit pupil of the objective.

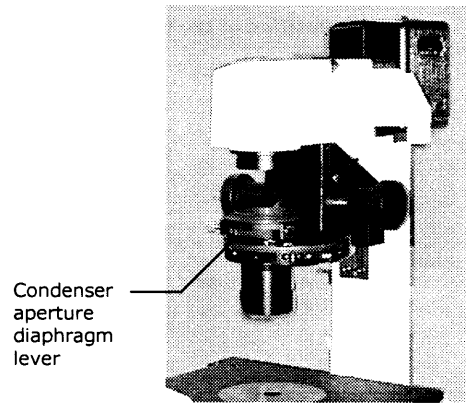

● T-TD eyepiece tube D or T-TERG ergonomic eyepiece tube:

Turn the eyepiece tube turret to "B" to move the Bertrand lens into the optical path. Turn the Bertrand lens focusing screw to observe an image of the objective's exit pupil (bright circle) and the aperture diaphragm.

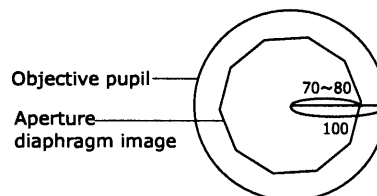
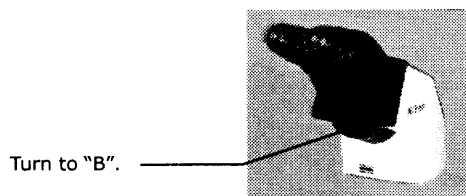

● Other eyepiece tubes:

Remove one eyepiece and insert the "centering telescope" with an adapter. Turn the eyepiece part of the centering telescope to focus on the exit pupil of the objective (bright circle) and the aperture diaphragm image.

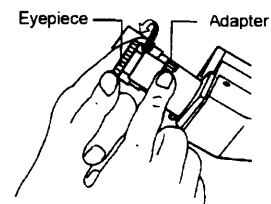

- When performing Ph microscopy with system condenser, be sure to fully open the aperture diaphragm. (If the aperture diaphragm is stopped down, the optical path will be obstructed.)
- The aperture diaphragm on "ELWD-S condenser" works only on position A (for bright-field microscopy) and has no effect on other positions (for Ph microscopy).
- There is no aperture diaphragm on "SLWD condenser".

7. Eyepiece tube turret

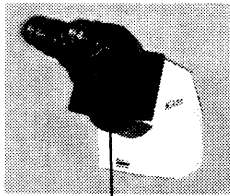
Position of the turret		Description
 <p>Eyepiece tube turret</p>	O	Empty
	B	Bertrand lens
	C	Shutter
	M	2.5X magnifier
		<p>The exit pupil of the objective can be observed. Turn the Bertrand lens focusing screw to focus on the exit pupil.</p> <p>If manipulator is used, this lens can also be used to observe the tip of the manipulator located just above the objective.</p> <p>Shuts out extraneous light entering the eyepieces.</p> <p>Applies 2.5x intermediate magnification only to the image seen through the eyepieces. Useful when slight enlargement is necessary or when performing focusing for photomicrography using 4 to 20X objective. (Not equipped on T-TERG ergonomic eyepiece tube.)</p>

- There is no eyepiece tube turret on "T-TS eyepiece tube S" and "T-TI intermediate tube".

8. System condenser

A condenser has dual functions. It condenses light, and provides the condensed light with optical elements to enable various types of microscopic applications.

Traditional microscopes require condensers to be changed according to microscopic applications; for example, a Ph condenser for Ph microscopy, and a DIC condenser for DIC microscopy.

The system condenser of this microscope features modules that contain the optical elements. Up to five modules can be incorporated into the unit. As a result, the user needs only to rotate the turret in order to execute various microscopic applications, without changing condensers.

Modules can be arranged freely in the turret if they are applicable to the condenser lens in use (there are 2 types of condenser lenses). Modules may be replaced without dismantling the condenser turret unit from the microscope, enabling several microscopic applications to be executed for a short period of time.

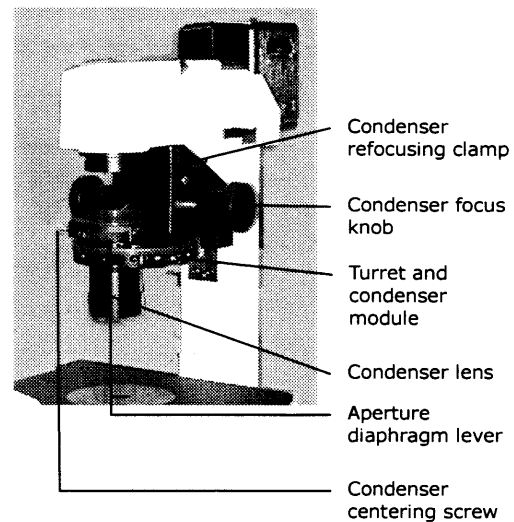

- For Ph microscopy, select the module having the same Ph code as marked on the objective. Bring it into the optical path and center the annular diaphragm. Be sure to keep the condenser aperture diaphragm fully opened or the optical path will be obstructed by the diaphragm.
- When using the T-CT-E motorized condenser turret, be sure to refer to the instruction manual supplied with the T-HUBC HUB controller.

● Specifications of the condenser lenses

	LWD condenser lens	ELWD condenser lens
N.A.	0.52	0.3
Working distance	30 mm	75 mm
Available microscopy	BF, Ph, DIC	BF, Ph
Usable condenser modules	For BF: "A" For Ph: "PhL", "Ph1", "Ph2", "Ph3" For DIC: "DIC L", "DIC M", "DIC H" For HMC: "MC1", "MC2", "MC3"	For BF: 「A」 For Ph: "PhL", "Ph1", "Ph2"
Others	* Condenser refocusing clamp can be used. * Supplementary lens is not used with this microscope.	

9. Objectives

Ph objectives

A Ph objective is labeled with a Ph code: PhL, Ph1, Ph2 or Ph3.

For Ph microscopy, use the annular diaphragm (condenser module) that has the same Ph code as the objective, regardless of the magnification of the objective.

Objective with correction ring

An inverted microscope is frequently used to observe specimens through the bottom plate of a laboratory dish or culture bottle made of glass or plastic. For such applications, the normal objectives (for 0.17 mm thick cover glass) may not provide clear images, disabling the microscope from demonstrating its full performances. In such cases, use an objective with a correction ring to compensate for bottom plate thickness.

Since the objectives with correction rings are not intended to compensate for wedge-like changes of thickness at edges of a container, we recommend that they should be used for compensation for even thickness.

● Adjusting the correction ring

- 1) Turn the correction ring to match the bottom plate thickness of the container. The thickness should be a measured value or the value stated by the manufacturer of the container. (The acrylic stage ring is available to improve working efficiency since it enables the part of operation to be seen from above the stage.)
- 2) Focus on the specimen with the focus knobs.
- 3) If the image has poor resolution and/or contrast, slightly rotate the correction ring clockwise or counterclockwise. When the correction ring is rotated, the specimen image becomes slightly out of focus. Focus on the specimen again with the fine focus knob.
- 4) If this has improved the resolution and contrast, rotate the correction ring further in the same direction, then adjust the focus again.
If the resolution and contrast are deteriorated, rotate the correction ring in the reverse direction double the amount rotated in previous turn, then adjust the focus.
In this way, rotate the correction ring in the same direction if a better image is obtained, or rotate it in this reverse direction if a poor image is obtained. Repeat this operation to find the best point.
- 5) Taking a note of the reading of a well-visible position on the correction ring will be a help when you later use containers having different bottom plate thickness. (The 0 mm position of the correction ring is used for microscopy of a specimen with no cover glass on an upright type microscopes.)

Cover glass thickness

On every objective, there is a mark indicating the thickness of the cover glass to be used with. ("∞ / 0.17" means to use a cover glass of 0.17 mm thick.) When observing with a "0.17" marked objective, place a specimen so that its cover glass (0.17 mm thick) faces the objective. (In case of an inverted microscope, set a specimen so that its cover glass faces down.) For an objective with a "1.2" mark, place a specimen so that its slide glass faces the objective, because the normal slide glass thickness is 1.2 mm. (In case of an inverted microscope, set a specimen so that its cover glass faces up.) When you observe a specimen in a laboratory dish or the like at high magnification through a glass not conforming to the specified thickness, we recommend use of an objective that has a correction ring capable of correcting the glass thickness error.

Oil immersion objective

The objective marked with "Oil" is an oil immersion objective.

Before using the oil immersion objective, be sure to immerse the space between the end of the objective and the specimen, with the supplied oil (Nikon immersion oil). Use the non-fluorescent oil (option) when you carry out fluorescent microscopy using the oil immersion objective for fluorescent microscopy.

Keep out air bubbles from the oil, since they will deteriorate visibility of images. Air bubbles may be found by observing the exit pupil (bright circle) of the objective. (To observe the exit pupil of the objective, turn the eyepiece tube turret to position "B" and focus with the Bertrand lens focusing screw. If your microscope does not have an eyepiece tube turret, remove one eyepiece and insert the centering telescope with an adapter and turn the eyepiece part of the centering telescope to focus.)

To remove air bubbles, rotate the revolving nosepiece slightly, and move the oil-immersed objective back and forth once or twice. Or, wipe the oil off, then reapply oil to the objective.

If excessive oil is applied, surplus oil flows out and adheres to the stage or other component. Use a minimum necessary amount of oil (enough to fill the space between the end of the objective and the specimen. Use care not to put oil to any other components.

If oil remains on the oil immersion objective or adheres to the surface of a dry objective, it will greatly reduce image visibility. After use, thoroughly wipe the oil off the objective surface. Also make sure that no oil has spread to the surfaces of other objectives.

To remove oil, moisten a lens tissue or clean cloth with petroleum benzine and lightly wipe the lens surface a few times. Use a fresh part of a lens tissue every time. For best results, wipe last with absolute alcohol (ethyl or methyl alcohol). If you cannot obtain petroleum benzine, use methyl alcohol. Because methyl alcohol is a weaker cleaning agent, you will need to wipe the surface repeatedly. (Usually, three or four wipes are adequate to clean the surface.)

Absolute alcohol and petroleum benzine are quite inflammable. Use great care when handling them and when setting the power switch on and off. Be very careful with fire.

The use of acrylic stage ring (option) will facilitate the immersion operation with the culture dish left on the stage. Set the stage ring so that its opening runs along the rim of the revolving nosepiece. Rotate the nosepiece till the objective shows from the opening of the stage ring and hold the nosepiece there to immerse the top lens of the objective.

Water immersion objective

The objective marked with "WI" is a water immersion objective. (The one with longer working distance is for the upright type microscopes.)

Before using the water immersion objective, be sure to immerse the space between the end of the objective and the specimen, with the demineralized or distilled water. (Do not use the tap water for immersion since when it dries up, impurities will stuck on the lens surface and may cause a scratch during cleaning.)

Plan Apo 60xWI objective (N.A. = 1.2) has a correction ring to compensate the difference of the cover glass thickness for the best aberration compensation. The mark "17" on the graduation shows the position for the 0.17 mm thick cover glass. Before using the cover glass, measure its thickness with the micrometer or the like, and set the correction ring to match that thickness for the best compensation.

10. Diopter adjustment

Perform diopter adjustment in the following way. The adjustment corrects dioptric difference of the left and right eyes, facilitates observation with both eyes, and reduces defocusing when changing the objectives.

For TE2000-E, TE2000-U

Turn the "photo-mask dial" on the front of the microscope counterclockwise to place the photo-mask in the optical path. Looking into the right eyepiece with your right eye, turn the diopter adjustment ring on the right eyepiece to focus on the double crosshairs.

Then, looking into the left eyepiece with your left eye, turn the diopter adjustment ring on the left eyepiece to focus on the double crosshairs.

For TE2000-S

Since there is no photo-mask on TE2000-S, the diopter adjustment cannot be performed in the same way as TE2000-U which uses double crosshairs on the photo-mask.

- 1) Perform steps 1 to 4 on bright field microscopy described on page 24 so that the specimen is in focus with 10x objective.
- 2) Turn the diopter adjustment rings of both eyepieces to align the engraved line on each diopter adjustment ring with the rim of the objective outer ring. (This sets the diopter adjustment to the "0" position.)
- 3) Bring the 40x objective in the optical path.
- 4) Look into the right eyepiece with your right eye. Turn the focus knob to focus on the specimen.
- 5) Bring the 4x or 10x objective in the optical path.
- 6) Look into the right eyepiece with your right eye, turn the diopter adjustment ring on the right eyepiece to focus on the specimen. (Do not touch the focus knob at this time.)
- 7) Repeat steps 3) to 6) twice.
- 8) Do the same for the left eyepiece. (Perform steps 3) to 6) three times substituting the word "right" with the word "left".)

11. Focusing module

● When using the TE2000-U/TE2000-S:

Never turn the focus knobs on the left and right sides of the microscope in opposite directions at the same time, as doing so can result in damage to the microscope.

Turning the coarse focus knob as far as it will go and then attempting to turn it further will result in damage to the microscope. Never use undue force to turn the knob.

The relationship between rotation of the knobs and movement of the objective is shown below. The fine/coarse focus knobs provide a 7-mm upward and 3-mm downward strokes from the reference position.

See the below chart for the relationship between the rotation of the focus knobs and the amount of movement.

Amount of rotation	Vertical movement of objective.
One graduation of fine focus knob	1 μ m
One rotation of fine focus knob	0.1 mm
One rotation of coarse focus knob	4.9 mm

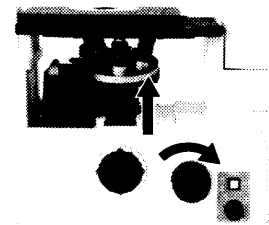

● **When using the TE2000-E:**

The fine adjustment function of the focusing module of the TE2000-E is motorized, and the fine focus knob is provided on the right side of the main body. The distance of movement achieved by one rotation of the fine focus knob can be set to Fine, Middle, or Coarse. (The knob is set to Coarse at the factory.) The current Z-axis position can be also displayed. For details, refer to the instruction manual supplied with the T-HUBC HUB controller.

The coarse focus knob on the left side of the main body is not motorized. The relationship between the amount of coarse focus knob rotation and the distance of objective movement is the same as in the TE2000-U.

■ **Supplementary information**

The distance of movement achieved by one rotation of the fine focus knob is as follows. Note that these distances are approximate and may vary depending on the knob-turning speed.

Fine: 25 μm /rotation

Middle: 50 μm /rotation

Coarse: 100 μm /rotation

Also note that the distance per rotation of the coarse focus knob is 4.9 mm.

Coarse focus knob torque adjustment ring _____

Rotating the torque adjustment ring on the left side of the microscope counter-clockwise will make the rotation of the coarse focus knob heavy.

Objective refocusing ring (not equipped on TE2000-S) _____

The objective refocusing ring on the right side of the microscope is used to mark the position of the coarse focus knob where a specimen is in focus.

Once the refocusing ring is clamped at the in-focus position, refocusing is much easier after shifting the objective for specimen change or other purpose. All you have to do is rotate the coarse focus knob until it reaches the limit.

The refocusing ring is useful if, for example, the objective is very close to the stage because the container of the specimen has a thick bottom plate, and the magnification can only be changed after lowering the objective.

When the refocusing ring is not used, be sure to turn it counterclockwise till the limit to loosen the clamp. If clamped, the focusing mechanism cannot be moved up from the clamped position with the coarse focus knob. However, stage movement with the fine focus knob is not affected.

- 1) At the position where a specimen is in focus, turn the refocusing ring clockwise to clamp the ring.
- 2) Lower the focusing mechanism by using only the coarse focus knob, and then change the objective.
- 3) Raise the focusing mechanism slowly to the limit, by using only the coarse focus knob. Here, the microscope is roughly in focus. Then, rotate the fine focusing knob to give a sharp focus.

12. T-DH dia-illuminator 100W

Condenser refocusing clamp (can be used only when LWD condenser lens is attached)

After focusing the field diaphragm image on the specimen surface using the condenser focus knob, turn the condenser refocusing clamp clockwise to mark that position.

Even if the condenser is raised for specimen replacement, it can be easily returned to the field diaphragm image in-focus position by only lowering it to the limit. It is very useful when high N.A. condenser lens is used or when the dia-illuminator cannot be tilted for specimen replacement. The condenser refocusing clamp works in range of 13 mm.

Condenser refocusing clamp

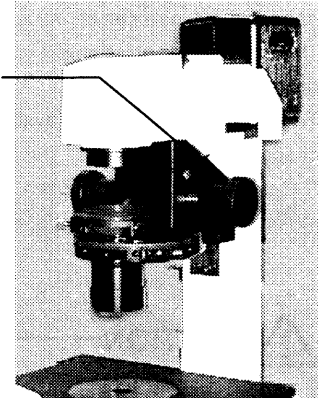

Rotating the condenser mount

To rotate the condenser mount, loosen the condenser mount rotation clamp screw.

This function is mainly used for adjusting the vibration direction on DIC microscopy.

When the system condenser is used and the polarizer is not attached (such as when performing bright-field or Ph microscopy), this function can be used to shift the condenser turret to the left or right to make space for the manipulator or the other system.

Condenser mount

Condenser mount rotation clamp screw

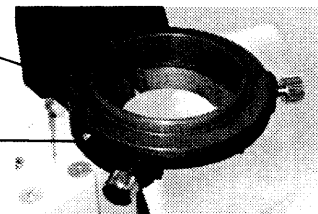

Tilting the pillar

The pillar can be tilted to provide a wider operation space which will be needed when changing a large-sized specimen. Loosen the tilting clamp screw at the rear of the illuminator and hold the front part of the illuminating section to tilt the illuminator backward.

Usually, the tilting clamp screw can be left unlocked.

When relatively heavy device is attached to the pillar, the tilting clamp screw should be locked to avoid the pillar from accidental tilt.

CAUTION

- Be careful not to get your fingers caught by the moving part of the dia-illuminator when tilting it.
- When attaching relatively heavy devices to the dia-illuminator (such as high intensity light source and its adapters), be sure to fix them tightly onto the illuminator or they will fall off when the illuminator is tilted.

Screw holes for mounting various devices

There are four M4 tapped holes on the front surface of the dia-illuminator. They can be used to fix manipulator and other devices. The upper two holes are for the devices that should be moved away from the stage when the dia-illuminator is tilted. The lower two holes are for the devices which should remain on the stage when the dia-illuminator is tilted.

13. T-SR rectangular stage

Normally, mount the stage so that its handle comes to the rear right of the microscope. It is also possible to mount the stage in the diagonally opposite position, with the handle at the front left. Since the universal joint is adopted on the handle, the handle can be adjusted to any angle.

There are tapped holes on the top and bottom plates of the stage, which can be used for mounting a manipulator or other devices.

Two types of stage rings are available: 20 mm diameter and 40 mm diameter. Use them selectively according to the sizes of specimen containers.

If the 40 mm stage ring is used, and the stage has been moved significantly out of observation range, the objective may strike the bottom of the stage when rotated. In this case, first lower the nosepiece to the limit and then rotate it.



CAUTION

The stage rack protrudes during operation. When operating the focusing knobs or the revolving nosepiece, be careful not to graze your hand on the end of the rack.

14. Photomicrography

For details on assembly and usage of the camera and the photomicrography equipment, see the instruction manual supplied with each equipment. Even if all microscope components are adjusted properly, you may find the image vignetted in the finder of the camera. This has no influence on photomicrography, however.

Photomicrography equipment and ports that accept them

See the chart below for the relationship between photomicrography equipment and the port that accepts them.

Photomicrography equipment	Port that accepts them	Adapters need (and its intermediate magnification)	Others
Digital still cameras (F-mount) that have "aperture opening priority auto mode (A)" such as D1X, D1H, D1, etc.	Front port	T-BFA F-mount adapter (1X)	Set the intermediate magnification dial to "1.5X." If it is set to "1X," the edges of the view field become darker.
35mm SLR camera (F-mount) that have "aperture opening priority auto mode (A)" such as FM3A, FE10, FE2, FE, F100, F90, F70, F801 series, F601 series, F501, F5, F4, F3, etc.	Front port	T-BSLR SLR camera adapter (2.5X)	
Digital still camera for microscopes DXM1200, DN100, etc.	Front port Side port Bottom port	T-BDCA direct C-mount adapter	
Photomicrographic equipment for microscopes U-III, H-III, P-III, etc.	Side port Observation port	For side port: T-BPA photo adapter For observation port: Attach to the vertical tube of the trinocular eyepiece tube of the upright microscopes, mounted on the intermediate tube	Needs PLI projection lens. When attached to TE2000-S, use of "photo-mask eyepiece" will enable focusing through eyepiece. When attached to the side port, the cover of the polaroid / 35mm camera back will not open fully. The rectangular photo-mask (not equipped on TE2000-S) shows the range to be taken on photo when PLI 2.5X is used. When other PLI lenses are used, check the range through the finder on the photomicrographic equipment.

Photomicrography procedure and items to be checked

On photomicrography, it is especially important to obtain appropriate illumination and focus the microscope properly. First adjust the microscope for usual observation. Then, check and perform the following

1	Perform diopter adjustment.	<p>For TE2000-E, TE2000-U: Rotate the diopter adjustment rings so that both the photo-mask and the specimen is in sharp focus.</p> <p>For TE2000-S: Switching between 10x and 40x objective, use focus knob and diopter adjustment rings in turn. (See page 45 for details.)</p>
2	Adjust illumination. Eliminate uneven illumination.	<p>Lamp voltage: For color photomicrography, set to the same indication as lamp ratings.</p> <p>Filters: For color photomicrography, set NCB11 filter in the optical path. Add color compensation filters if necessary.</p> <p>Condenser: Perform focusing and centering of the condenser (if T-DH diaphragm 100W is used). On Ph microscopy, perform annular diaphragm centering.</p> <p>Aperture diaphragm is to be set to 70 to 80% of objective N.A. on normal use, and to be opened fully on Ph observation with system condenser.</p> <p>Camera: "+2/3" exposure adjustment will have good results when 35mm SLR camera is attached to the front port.</p>
3	Switch the optical path	<p>Use the optical path switchover dial, remote control pad, or PC to guide the image to the port on which the photomicrography equipment is attached.</p> <p>(If this results in sending 100% light to the specified port, you will need to switch back to the observation port frequently.)</p>
4	Check the trimming.	<p>For TE2000-E, TE2000-U: Use the photo-mask.</p> <p>For TE2000-S: Attach the "mask eyepiece" instead of an eyepiece and check, or look through the finder on the camera or photomicrography equipment.</p>
5	Focus on the film surface.	<p>For TE2000-E, TE2000-U: Turn the focus knob so that both the photo-mask and the specimen image is in sharp focus. When using 4 to 40x objective, turn the eyepiece tube turret (not equipped on T-TS eyepiece tube S or T-TI intermediate tube) to "M" to enlarge the image on eyepiece only, and focus precisely. (Do not touch the diopter adjustment ring after turning the eyepiece tube turret to "M".)</p> <p>For TE2000-S: Focus on the specimen while looking through the finder on the camera or photomicrography equipment, or through mask eyepiece.</p> <p>If objective with correction ring is used, check the settings of the correction ring.</p>
6	Shut out the extraneous light.	<p>Field diaphragm: Close down to a size slightly larger than the photo frame.</p> <p>Eyepieces: Turn the eyepiece tube turret (not equipped on T-TS eyepiece tube S or T-TI intermediate tube) to "C". Or, cover the eyepieces with a piece of cloth.</p> <p>Finder on camera or photomicrography equipment: Cover the finder with a piece of cloth or a finder cap. (Always leave the cover on, unless required to look into the finder.)</p>
7	Eliminate the influence of vibration.	<p>If exposure time is shorter than "1/8s", insert ND filters in the optical path to make the time longer than "1/8s".</p> <p>(If monochromatic film is used, you can also use lamp voltage to darken the image.)</p> <p>Use release or self-timer of the camera.</p>
8	Make exposure.	

Photo-mask and the range to be taken on photo

(Photo-mask is not equipped on TE2000-S.)

Turning the photo-mask dial counter-clockwise will bring photo-mask in the optical path. The photo-mask can be used for diopter adjustment or trimming on photomicrography.

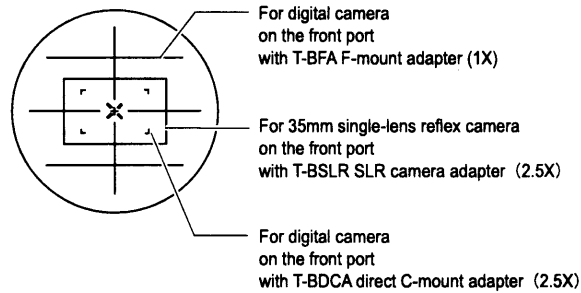

Mask eyepiece and the range to be taken on photo

Remove one eyepiece and insert the "mask eyepiece" instead. This will enable trimming for photomicrography from the binocular part of the microscope even with TE2000-S that does not have the eyepiece tube turret. It should be noted however, that the range shown by the mask eyepiece is only a rough guide. If precise trimming is required, look and check through the finder on the camera or the photomicrography equipment.

The following illustration shows the range taken on photo when the photomicrography equipment is attached on the side port. (The range differs according to the magnification of the projection lens.)

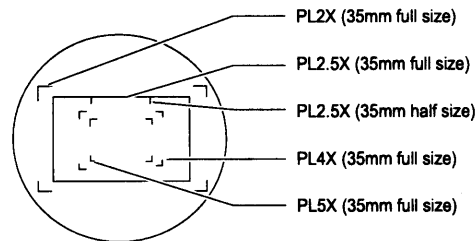

IV. Assembly



WARNING

- Before assembling the instrument, read the "⚠ WARNING", "⚠ CAUTION", and "Notes on handling the microscope" at the beginning of this manual and be sure to follow the warnings and cautions written therein.
- To prevent electric shock and fire, turn off all the power switches of the system and unplug the power cords.



CAUTION

- Be careful not to pinch your hands or fingers during assembly.
- Scratches or fingerprints on lenses will adversely affect the image. Assemble the microscope so as not to put scratches on the lenses.
- The microscope is a precision optical equipment. Handle carefully and do not subject it to strong shocks. (The precision of the objectives in particular can be adversely affected even by weak shocks.)

- When using the TE2000-E
 - When mounting the T-HUBC HUB controller on the rear side of the TE-2000U
 - When mounting the T-HUBC HUB controller on the rear side of the TE-2000S



Also refer to the instruction manual supplied with the T-HUBC HUB controller.

Required tools: 2mm hexagonal screwdriver x2 (supplied)
4mm hexagonal wrench x1 (supplied)

Installation location: Refer to the "Notes on handling the microscope" on the top of this manual and select an appropriate location.

Combination of "T-DH dia-illuminator 100W" and "system condenser"

Combination of "T-DS dia-illuminator 30W" and "ELWD-S condenser"

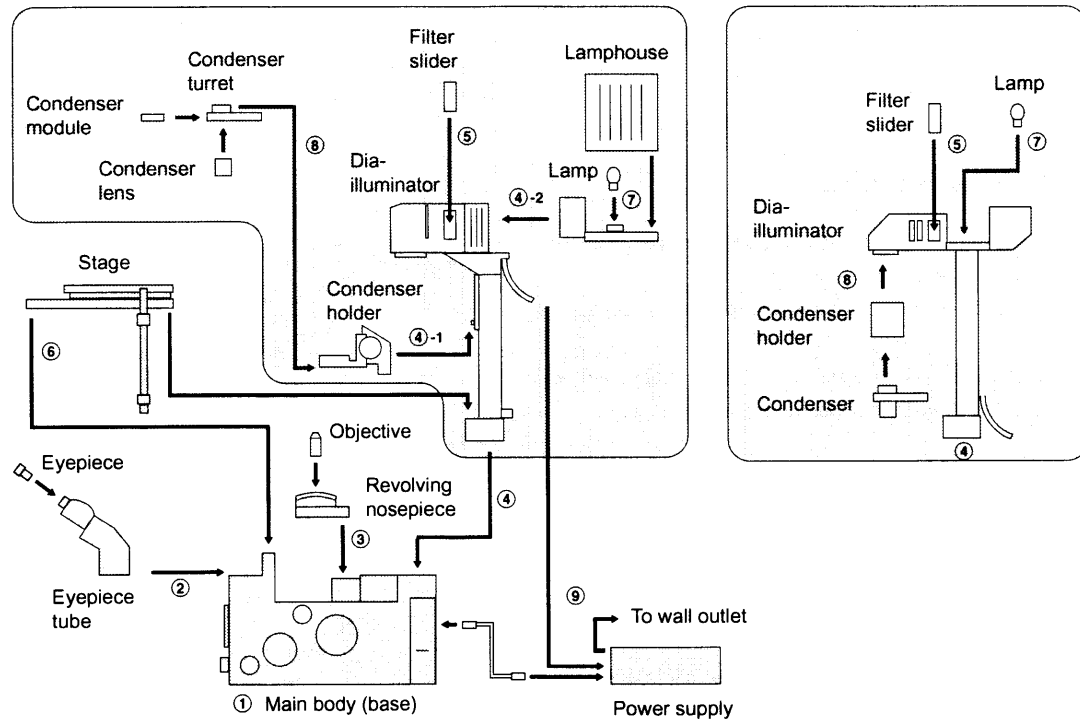

Checking the power supply voltage

Make sure that the input voltage indicated on your power supply corresponds with the voltage of the commercial power supply in your area. If the two values do not match, do not use the power supply, and contact your nearest Nikon representative immediately. Use of a power supply with a different input voltage indication can result in electric shock, fire, malfunction, and/or other accidents.

1. Setting the main body (base)

Take out the microscope base from the box and settle it on a stable desk.

The base is heavy. Hold it securely by the dent at the lower front and the carrying handle at the rear.

2. Eyepiece tube

- 1) Loosen the eyepiece tube clamp screw at the front of the base using hexagonal screwdriver.
- 2) Remove the rubber cover.
- 3) Slide on the eyepiece tube from the front side till it hits the limit, and then fix it by the clamp screw.
- 4) Put on the rubber cover.
- 5) Attach the eyepieces.
(Match 3 grooves on the eyepiece with 3 projections on the eyepiece sleeve. The eyepieces on the right and left should be of the same magnification. If you have rubber eye guards, put it on the eyepieces.)

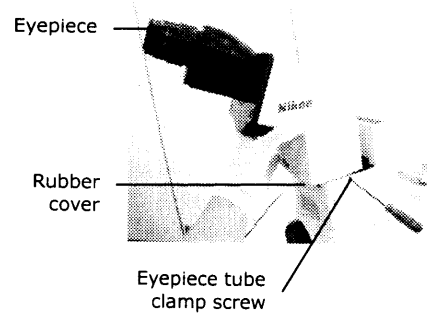

3. Revolving nosepiece

Attach the revolving nosepiece to the rectangular groove at the center of the microscope.

Pressing the nosepiece from the front side to the rear, secure it by two M5 hexagonal head bolts.

Screw on the objectives in an order that the magnification increases as the nosepiece is turned clockwise when seen from above.

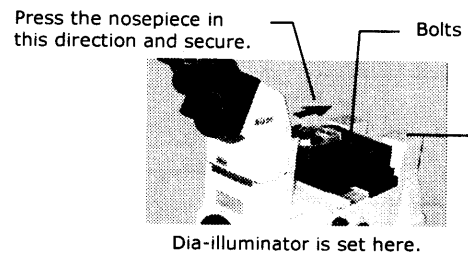

4. Dia-illuminator

Remove the carrying handle from the base.

Place the dia-illuminator on the rear mount. Make sure that the positioning pins on the mount fit into the holes on the illuminator.

Fix the illuminator with four M5 hexagonal head bolts supplied together.

If "T-DH dia-illuminator 100W" is to be used, do the following also.

1) Attach the condenser mount

Attach the condenser mount sliding it from the bottom to the top along the dovetail groove. (Slide it up until it hits the limit.)

Fix the condenser mount securely with the clamp screw on the right side.

Attach the stopper screw to the illuminator.

When using a condenser lens other than the ELWD or ELWD-S, loosen the clamp screw, slide the condenser mount down until it makes contact with the stopper screw, then tighten the clamp screw firmly.

2) Attach the lamphouse

Insert the lamphouse to the top part of the dia-illuminator.

Make sure that the positioning pin on the illuminator fits into the groove on the circular mount of the lamphouse.

Securely fix the lamphouse by the clamp screw on the right side of the illuminator.

**Caution for heat:
Do not touch while the lamp is lit or immediately after the lamp is distinguished**

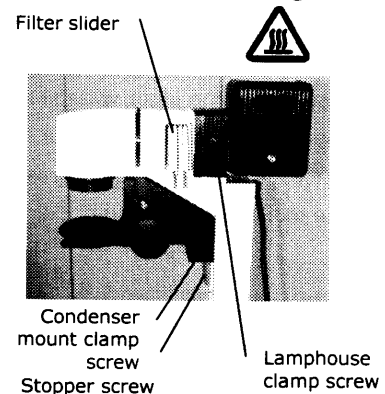

5. Filter slider

Attach the filters to the filter sliders. (Push aside the claw on the circular mount when attaching the filter.)

Insert the sliders on the dia-illuminator.

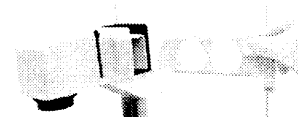

6. Stage

Place the stage on the mounts at the center front of the base and the dia-illuminator.

(If your stage is equipped with the movement handle, let it position at the right rear of the microscope though it can also be positioned at front left.)

Fix the stage with four M5 hexagonal bolt supplied together with the stage.

7. Lamp installation (lamp exchange)



CAUTION

- The combination of the lamp, dia-illuminator and the power supply is fixed. See page 37 and use them in correct combination. Be sure to use the specified lamp.
- When exchanging the lamp, turn off the power and unplug the power cord to avoid electric shock.
- The lamp and its surroundings become extremely hot during lamp illumination and immediately after the lamp is distinguished. When exchanging the lamp, turn off the lamp and wait till the lamp cools sufficiently.
- Do not touch the lamp with bare hands. Dusts and fingerprints on the lamp surface will lead to uneven illumination and shortening of the lamp life. Use gloves.

When using "T-DH dia-illuminator 100W":

- Remove the cover of the lamphouse by loosening the clamp screw on the right side of the cover.
- Securely insert the lamp to the lamp socket till the limit while pressing down the lamp clamp lever.
- Slowly release the lamp clamp lever. Make sure that the lamp is not tilted. If so, reattach the lamp.
- Return the cover to the lamphouse and fix it by the clamp screw.

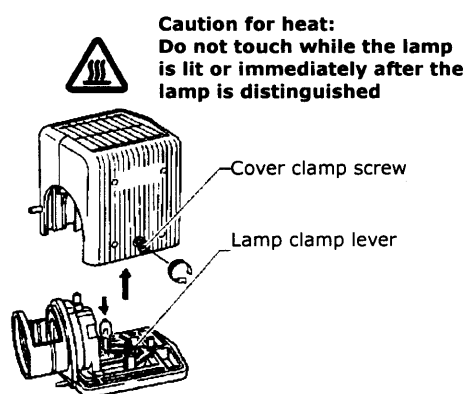

When using "T-DS dia-illuminator 30W":

- Open up the cover at the rear part of the dia-illuminator.
- Attach the lamp to the socket.
- Close the cover

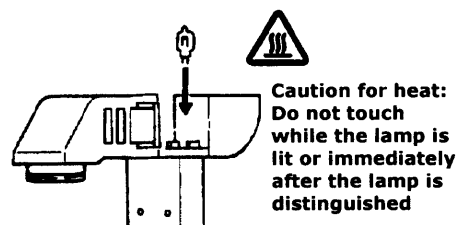

8. Condenser

When "T-DH dia-illuminator 100W" is used:

(Attachable condensers:

System condenser or ELWD-S condenser)

Loosen the condenser clamp screw inside the hole at the right side of the condenser holder using hexagonal screwdriver. (If the mount has been rotated from its standard position, the condenser clamp screw cannot be found inside the hole. In the case like this, loosen the condenser mount rotation clamp screw and rotate the condenser mount with your hand so that the positioning groove on the mount matches the positioning pin on the condenser holder. Tighten the rotation clamp screw at that position.)

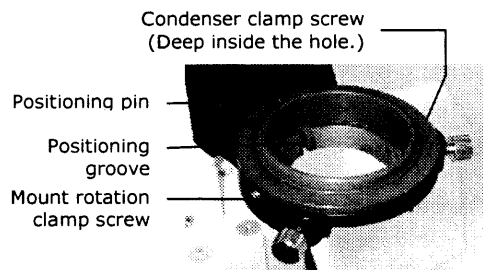

Attaching the "system condenser":

- 1) Rotate the turret so that the module "A" (hollow module for bright-field microscopy) comes into the optical path.
- 2) Slide on the turret to the bottom mount of the condenser holder so that the indication "A" faces front. Fix the turret securely by the condenser clamp screw.
- 3) Insert the modules to the turret and fix each of them by two hexagonal screws. Five modules can be attached to the turret. Set them so that the indication on the module increases as the turret is rotated clockwise when seen from above.)
- 4) Screw on the condenser lens to the bottom of the turret. (See page 43 for the correct combination of the module and the condenser lens. The auxiliary lens supplied with the LWD condenser lens is not used on this microscope.)

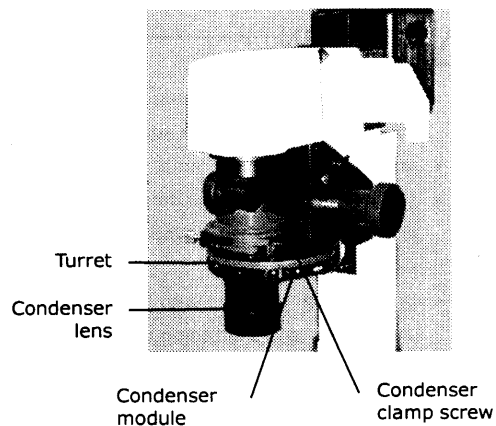

Attaching the "ELWD-S condenser":

Insert it into the bottom mount of the condenser holder so that the turret indication faces front. Fix it securely with the condenser clamp screw.

When "T-DS dia-illuminator 30W" is used:

(Attachable condensers:

ELWD-S condenser, SLWD condenser or HMC condenser)

Attaching the "ELWD-S condenser":

- 1) Attach the condenser holder on the dia-illuminator.
- 2) Attach the ELWD-S condenser on the condenser holder.

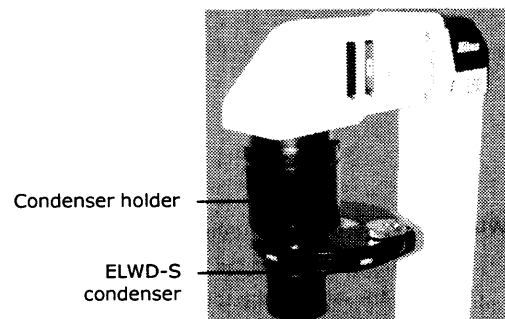

Attaching the "SLWD condenser":

- 1) Remove the dustproof and field diaphragm sliders from the illuminator.
- 2) Insert the SLWD condenser lens to the front, and Ph annular diaphragm slider to the rear opening.

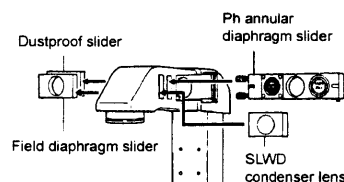

Attaching the "HMC condenser":

- 1) Screw on the 52mm polarized filter inside the extension tube supplied together with the HMC condenser lens.
- 2) Attach the extension tube to the dia-illuminator.
- 3) Attach the condenser holder to the extension tube.
- 4) Attach the condenser turret to the condenser holder.
- 5) Screw on the HMC condenser lens to the turret.
- 6) Attach the HMC module to the turret.

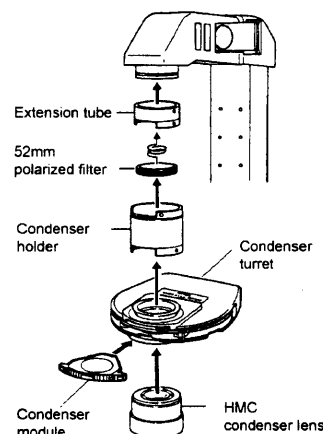

9. Power supply

First make sure that the power switch is turned off (pressed to the O side).

1) Lamp cable

Lamp cable of the dia-illuminator is to be connected to the "OUTPUT" connector on the power supply. Do not forget to tighten the lock ring on the connector.

2) Control cable

Connect one side the "LAMP CTRL" connector on the microscope, and the other side to the "EXTERNAL" connector on the power supply. (If TE-PS30 or TE-PSE30 power supply is used, connect to "CTRL" connector instead of the EXTERNAL connector.)
When installing the HUB controller, be sure to refer to the instruction manual supplied with the HUB controller.

3) Power cord

Connect one side to the "AC IN" connector on the power supply, and the other side to the wall outlet.

If other devices, such as photomicrographic equipment, are to be attached to the microscope, the power cord should be connected only after those devices are attached to the microscope.

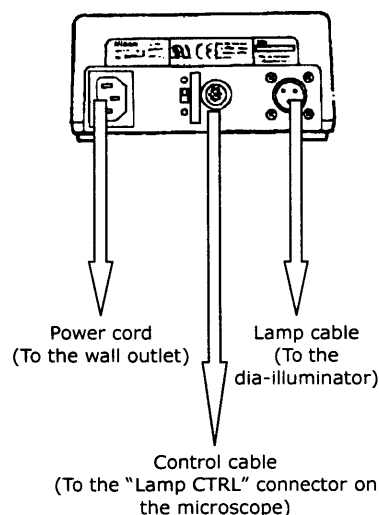

This ends the assembly of normal set.

10. Front port

See page 49 for the photomicrography devices that can be attached to the front port and the adapters needed.

- 1) Pull off the plastic cap on the front port with your hand.
- 2) Insert the adapter and fix it by the clamp screw.
(If the adapter has a positioning pin, match it with the positioning groove on the front port.)
- 3) Attach the photomicrography device to the adapter. have rubber eye guards, put it on the eyepieces.)

Ex.: Attaching "Digital still camera D1" to "T-BFA F-mount adapter"

Remove the cap on the F-mount adapter. Attach the camera to the adapter matching the index marks, and rotate the camera in the direction shown by the arrow on the mount (counterclockwise) till a click is heard.

Dismounting the camera:

Pressing the lens dismounting button on the camera, slowly rotate the camera clockwise until it stops.

Note that the F-mount may be damaged if you attempt to rotate the camera in the direction of the arrow.

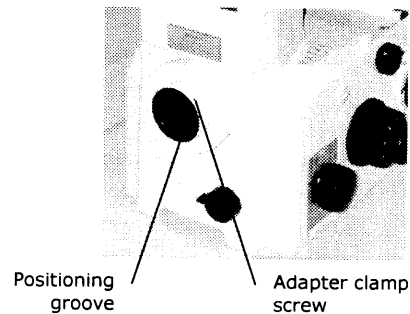

11. Side port

See page 49 for the photomicrography devices that can be attached to the side port and the adapters needed.

- 1) Remove the plastic cap on the side port by loosening the clamp screw.
- 2) Insert the side port adapter and fix it by the clamp screw.
- 3) Insert the adapter to the side port adapter and fix it by the clamp screw.
- 4) Attach the photomicrography device to the adapter.

Ex.: Attaching "Photomicrographic equipment U-III" to "T-BPA photo adapter"

Insert the PLI projection lens to the "T-BPA photo adapter" till it hits the limit. Insert the photomicrographic equipment to the adapter so that its finder faces forward. Fix it by tightening the connection ring.

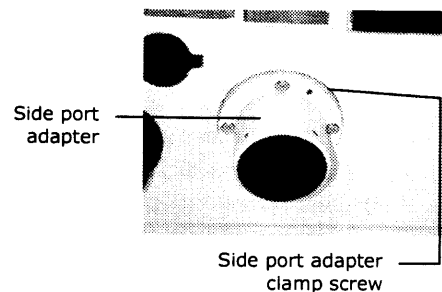

12. Attaching various devices to the observation port

Remove the eyepiece tube from the microscope and attach the "T-TI intermediate tube" instead. The intermediate tube accepts various devices such as the trinocular eyepiece tube for upright type microscopes and teaching head.

V. Troubleshooting

If the microscope does not function properly, take appropriate action as described below.

1. Optical

Symptoms	Causes	Countermeasures
View field vignetting. Uneven brightness in the view field. View field not visible.	Parts not correctly installed.	Install the parts (nosepiece, condenser, etc.) correctly.
	Movable parts not switched correctly.	Rotate the parts till the click stop position or till the limit. (Parts such as optical path switchover dial, nosepiece, filter sliders, condenser turret, eyepiece tube turret and photo-mask dial.)
	Stage ring on the optical path.	Change the specimen position.
	Field diaphragm image not focused on the specimen surface.	Perform condenser focusing and centering correctly.
	Field diaphragm stopped down too far.	Open to slightly large a size as the view field.
	Dirt or dust on lens and container.	Clean them. Use clean container.
Dirt or dust in the view field.	Dirt or dust on lens and container.	Clean them. Use clean container.
	Field diaphragm image not focused on the specimen surface.	Perform condenser focusing and centering correctly.
Poor image quality. Poor contrast. Poor resolution.	Dirt or dust on lens and container.	Clean them. Use clean container.
	Objective's correction ring not set to the bottom plate thickness of the container.	Adjust correctly.
	Bottom plate thickness of the container is outside the correction range of the objective.	Use container with bottom plate thickness within correction range.
	Field diaphragm image not focused on the specimen surface.	Perform condenser focusing and centering correctly.
No phase contrast effect. (on Ph microscopy)	Bright-field objective is used.	Use Ph objective.
	Condenser annular diaphragm not on optical path.	Put the annular diaphragm that matches the Ph code of the objective into the optical path.
	Condenser annular diaphragm not centered.	Center the annular diaphragm.
	Aperture diaphragm not fully open (when using system condenser).	Open fully.
Uneven focus.	Revolving nosepiece not installed correctly, or not rotated to the click stop position.	Install correctly and rotate to the click stop position.
Image flows.	Specimen tilted against stage surface.	Correctly reposition specimen on stage.
	Revolving nosepiece not installed correctly, or not rotated to the click stop position.	Install correctly and rotate to the click stop position.
	Condenser annular diaphragm not centered.	Center the annular diaphragm.
	Dia-illuminator tilted.	Raise till it hits the limit.
Yellowish image.	No NCB11 filter in the optical path.	Put it in the optical path.
	Lamp voltage too low.	Adjust the brightness adjustment dial to match the lamp ratings.

Symptoms	Causes	Countermeasures
View field too bright.	No ND filter in optical path.	Put it in the optical path.
	Lamp voltage too high.	Lower the voltage with brightness adjustment dial.
View field too dark.	Condenser aperture diaphragm stopped down too far.	Normally, set to 70 to 80% of the objective N.A.
	Field diaphragm image not focused on the specimen surface.	Perform condenser focusing and centering correctly.
	Optical path switchover dial not set to 100% observation.	Switch to 100% observation.

2. Operational

Symptoms	Causes	Countermeasures
Image not in focus although the objective is raised to the highest position.	Stage mounted incorrectly.	Mount it correctly.
	Objective refocusing ring clamped.	Release the clamp by turning the ring counterclockwise to the limit.
Cannot focus with 20x and 40x objective.	Bottom plate thickness of the container is outside the correction range of the objective.	Use container with bottom plate thickness within correction range.
Images on the left and right eyepieces not coincident.	Interpupillary adjustment not performed.	Make adjustment.
Eye fatigue	Diopter adjustment not performed.	Make adjustment.
	Inadequate brightness.	Adjust with brightness adjustment dial or ND filters.

3. Electrical

Symptoms	Causes	Countermeasures
Power does not turn on even though the power switch is set to on.	Power cord not connected, or connected improperly.	Connect properly.
Lamp does not light.	Lamp burnt.	Replace with specified lamp.
Lamp burnt too early.	Non-conforming lamp used.	Replace with specified lamp.
Brightness adjustment dial on the microscope does not work.	Control cable not connected.	Connect properly.
	EXTERNAL switch on the power supply (CTRL switch when TE-PS30/TE-PSE30 is used) is OFF.	Turn ON.
Dia-illumination ON/OFF switch on the microscope does not work.	Lamp burnt.	Replace with specified lamp.
	Control cable not connected.	Connect properly.
Brightness adjustment dial on the power supply does not work.	EXTERNAL switch on the power supply (CTRL switch when TE-PS30/TE-PSE30 is used) is ON.	Turn OFF.

VI. Care and maintenance

1. Lens Cleaning

Do not let dust, fingerprints, etc., get on the lenses. Dirt on the lenses, filters, etc., will adversely affect the view of the image. If any of the lenses get dirty, clean them as described below.

- Either brush away dust with a soft brush, or else wipe it away gently with gauze.
- Only if there are fingerprints or grease on a lens, dampen a piece of soft, clean cotton cloth, lens tissue, or gauze with absolute alcohol (ethyl or methyl alcohol) and wipe.
- Only when removing the immersion oil off from the objective, use petroleum benzene. If you cannot obtain petroleum benzene, use methyl alcohol. However, because methyl alcohol does not clean as well as petroleum benzene, it will be necessary to wipe the surfaces repeatedly. (Usually, three or four times is sufficient to clean the lenses.)
- Never use petroleum benzene to clean the entrance lens at the bottom of the eyepiece tube or orusn surface of the eyepiece tube.
- Absolute alcohol and petroleum benzene are highly flammable. Be careful when handling it, when around open flames, when turning the power switch on / off, etc.
- Follow the instructions provided by the manufacturer when using absolute alcohol.

2. Cleaning the painted, plastic and printed parts

Do not use organic solvents (such as alcohol, ether, or paint thinner) on painted, plastic or printed parts. Doing so could result in discoloration or in the peeling of printed characters. For persistent dirt, dampen a piece of gauze with neutral detergent and wipe lightly.

3. Storage

Store the microscope in a dry place where mold is not likely to form.

Store the objectives and eyepieces in a desiccator or similar container with a drying agent.

Put the vinyl cover over the microscope to protect it from dust.

Before putting on the vinyl cover, turn off the power switch on the microscope (flip it to the O side) and wait until the lamphouse is cool.

4. Periodical inspections (charged)

Periodical inspections (expenses charged) of this microscope are recommended in order to maintain peak performance. Contact your nearest Nikon representative for details.

VII. Electrical specifications

1. When the microscope (TE2000-E, TE2000-U, TE2000-S) is used in combination with T-DH dia-illuminator 100W (for 12V100W lamp)

Combination	T-DH dia-illuminator 100W + TE2-PS100W power supply
Input ratings of T-DH dia-illuminator 100W	DC 12 V, 100 W
Lamp ratings	12V100W halogen lamp
Lamp type	Halogen lamp (OSRAM HLX 64623 or PHILIPS 7724I)
TE2-PS100W power supply	Input ratings: AC 100-240 V, 50/60 Hz, 2.4 A Voltage fluctuation: $\pm 10\%$ Output ratings: DC 12 V, 100 W, 8.4 A Built-in fuse ratings: 250 V, T4A Protection class: Class 1 Others: UL Recognized product, GS approved
Operating environmental conditions	Altitude: 2,000 m max. Temperature: 0 to 40°C Relative humidity: 85% max. (non-condensing) Pollution degree: Degree 2 Indoor use only
Installation category	Category II

2. When the microscope (TE2000-E, TE2000-U, TE2000-S) is used in combination with the T-DS dia-illuminator 30W (for 6V30W lamp)

Combination	<p>When the supply voltage is 100 to 120 V: T-DS dia-illuminator 30W + TE-PS30 power supply</p> <p>When the supply voltage is 220 to 240 V: T-DS dia-illuminator 30W + TE-PSE30 power supply</p>
Input ratings of T-DS dia-illuminator 30W	DC 6 V, 30 W
Lamp ratings	DC 6V30 W halogen lamp
Lamp	Halogen lamp (PHILIPS 5761)
<p>TE-PS30 power supply</p> <p>TE-PSE30 power supply</p>	<p>Input ratings: TE-PS30: AC 100-120 V, 50/60 Hz, 0.6 A TE-PSE30: AC 230 V, 50/60 Hz, 0.4 A</p> <p>Voltage fluctuation: ±10%</p> <p>Output ratings: DC 6 V, 30 W</p> <p>Built-in fuse ratings: 250 V, F2AH</p> <p>Protection class: Class 1</p> <p>Others: TE-PS30: UL Recognized product TE-PSE30: GS approved</p>
Operating environmental conditions	<p>Altitude: 2,000 m max.</p> <p>Temperature: 0 to 40°C</p> <p>Relative humidity: 85% max. (non-condensing)</p> <p>Pollution degree: Degree 2</p> <p>Indoor use only</p>
Installation category	Category II

3. Specified AC adapter for use with the HUB controller (only when using the T-HUBC HUB controller)

Manufacturer	Tamura Corp.
Type	EXA 1230N
Input rating	AC 100-240 V, 0.9 A, 50/60 Hz
Output rating	DC 12 V
Rated output current	3A
Others	UL Recognized product, GS approved, CE satisfied

4. Power cord

Be sure to use the following power cords.

Power cord for power supply	<p>When the supply voltage is 100 to 120 V</p> <p>UL Listed detachable cord set, 3 conductor grounding Type SVT, No. 18 AWG, 3 m long maximum, rated at 125 V AC minimum.</p> <p>When the supply voltage is 220 to 240 V</p> <p>Approved according to EU/EN standards, 3 conductor grounding Type HO5VV-F, 3 m long maximum, rated at 250 V AC minimum.</p>
Power cord for AC adapter of HUB controller	<p>When the supply voltage is 100 to 120 V</p> <p>UL Listed detachable cord set, 2 conductor Type SPT-1, No. 18 AWG, 3 m long maximum, rated at 125 V AC minimum.</p> <p>When the supply voltage is 220 to 240 V</p> <p>Approved according to EU/EN standards, 2 conductor Type HO3VVH2-F, 3 m long maximum, rated at 250 V AC minimum.</p>

5. Conforming standards

The TE2000 Series is designed and tested to comply with the EN61010-1 part 1 (*) and UL3101-1 standards. The TE2000 Series also meets the requirements of the EU Low Voltage Directive and EMC Directive.

(* Safety standard applied to electrical equipment for measurement, control, and laboratory use.)

<p>Microscope (TE2000-E, TE2000-U, TE2000-S) used in combination with the TE2-PS100W power supply or TE-PS30 power supply</p>	<p>UL Listed Product.</p>
	<p>FCC 15B, Class A satisfied.</p> <p>This equipment has been tested and found to comply with the limits for a Class A digital device, pursuant to Part 15 of the FCC Rules.</p> <p>These limits are designed to provide reasonable protection against harmful interference when the equipment is operated in a commercial environment.</p> <p>This equipment generates, uses, and can radiate radio frequency energy and, if not installed and used in accordance with the instruction manual, may cause harmful interference to radio communications.</p> <p>Operation of this equipment in a residential area is likely to cause harmful interference in which case the user will be required to correct the interference at his own expense.</p> <p>This class A digital apparatus meets all requirements of the Canadian Interference-Causing Equipment Regulations.</p> <p>Cet appareil numérique de la Calss A respecte toutes les exigences du Règlement sur le matériel brouilleur du Canada.</p>

* Note that the microscope will not meet the above standards if used in combination with a motorized XY stage or shutter made by any manufacturer other than Nikon.

<p>Microscope (TE2000-E, TE2000-U, TE2000-S) used in combination with TE2-PS100W power supply or TE-PSE30 power supply</p>	<p>GS approved.</p>
	<p>EU Low Voltage Directive satisfied.</p> <p>EU EMC Directive satisfied.</p> <div style="text-align: right;">  </div>

* Note that the microscope will not meet the above standards if used in combination with a motorized XY stage or shutter made by any manufacturer other than Nikon.

NIKON CORPORATION / 株式会社 ニコン

2-3, Marunouchi 3-chome, Chiyoda-ku, Tokyo 100-8331, Japan
〒100-8331 東京都千代田区丸の内3-2-3 (富士ビル)

NIKON INSTECH CO., LTD. / 株式会社 ニコン インステック

Parale-Mitsui Bldg., 8, Higashida-cho, Kawasaki-ku, Kawasaki, Kanagawa, 210-0005 Japan	TEL +81-44-223-2161	FAX +81-44-223-2182
本社 210-0005 川崎市川崎区東田町8番地 パレール三井ビルディング13階	電話 (044) 223-2160	FAX (044) 223-2180
札幌営業所 001-0011 札幌市北区北11条西4-1-40 (すばるビル)	電話 (011) 746-9381	FAX (011) 746-9398
仙台営業所 980-0014 仙台市青葉区本町2-15-1 (ルナール仙台ビル)	電話 (022) 227-1298	FAX (022) 227-0331
名古屋営業所 460-0002 名古屋市中区丸の内3-20-17 (中外東京海上ビル)	電話 (052) 954-0165	FAX (052) 954-0166
第2名古屋営業所 460-0002 名古屋市中区丸の内3-20-17 (中外東京海上ビル)	電話 (052) 954-0185	FAX (052) 954-0188

●系列会社●

株式会社コーガク【大阪(本社)、京都、明石、金沢】

本社 561-0841 豊中市名神口3-8-2	電話 (06) 6333-3191
京都支社 606-8221 京都市左京区田中西樋ノ口町80	電話 (075) 781-1170

株式会社大熊商会【福岡(本社)、北九州、長崎、大分、熊本、宮崎、延岡、鹿児島】

本社 813-0034 福岡市東区多の津1-4-1	電話 (092) 611-1111
---------------------------	-------------------

NIKON INSTRUMENTS INC.

1300 Walt Whitman Road, Melville, NY 11747-3064, U.S.A.
Tel: +1-631-547-8500 Fax: +1-631-547-0306

NIKON INSTRUMENTS EUROPE B.V.

Schipholweg 321, P.O. Box 222, 1170 AE Badhoevedorp, The Netherlands
Tel: +31-20-44-96-222 Fax: +31-20-44-96-298