

SpectraSystem™ SCM1000

Vacuum Membrane Degasser Reference Manual

A0099-509 Revision D

June 2006

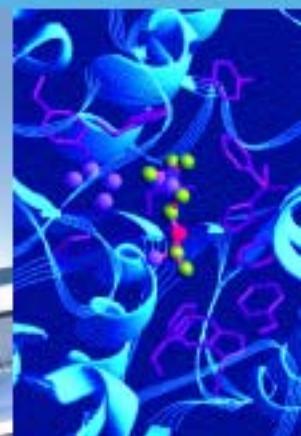
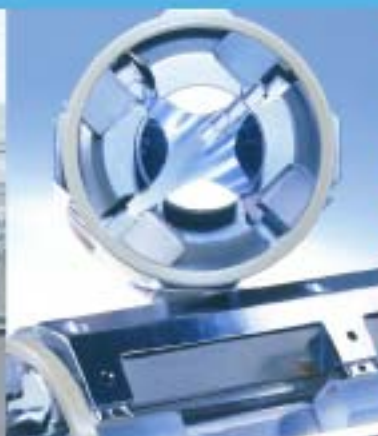

© 2006 Thermo Electron Corporation. All rights reserved.

SpectraSYSTEM™ is a trademark of Thermo Electron Corporation. Teflon® is a registered trademark of E.I. du Pont de Nemours & Co.

This document is provided to customers who have purchased Thermo Electron Corporation equipment to use in the operation of such Thermo Electron Corporation equipment. This document is copyright protected and any reproduction of this document or any part of this document is strictly prohibited, except as Thermo Electron Corporation may authorize in writing.

Technical information contained in this publication is for reference purposes only and is subject to change without notice. Every effort has been made to supply complete and accurate information; however, Thermo Electron Corporation assumes no responsibility and will not be liable for any errors, omissions, damage, or loss that might result from any use of this manual or the information contained therein (even if this information is properly followed and problems still arise).

This publication is not part of the Agreement of Sale between Thermo Electron Corporation and the purchaser of an LC/MS system. In the event of any conflict between the provisions of this document and those contained in Thermo Electron Corporation's Terms and Conditions, the provisions of the Terms and Conditions shall govern.

System Configurations and Specifications supersede all previous information and are subject to change without notice.

Preface

About This Guide

This guide describes how to operate and maintain the SCM1000 vacuum membrane degasser.

Contacting Us

There are several ways to contact Thermo Electron Corporation.

Assistance

For new product updates, technical support, and ordering information, contact us in one of the following ways:

Visit Us on the Web

www.thermo.com/finnigan

Contact Technical Support

Phone: 1-800-685-9535

Fax: 1-561-688-8736

E-mail: techsupport.finnigan@thermo.com

Find software updates and utilities to download at <http://mssupport.thermo.com>.

Contact Customer Service

In the US and Canada for ordering information:

Phone: 1-800-532-4752

Fax: 1-561-688-8731

Web site: www.thermo.com/finnigan

Changes to the Manual and Online Help

To suggest changes to this guide or to the online Help, use either of the following methods:

- Fill out a reader survey online at www.thermo.com/lcms-techpubs
- Send an e-mail message to the Technical Publications Editor at techpubs.finnigan-lcms@thermo.com

WEEE Compliance

This product is required to comply with the European Union's Waste Electrical & Electronic Equipment (WEEE) Directive 2002/96/EC. It is marked with the following symbol:



Thermo Electron has contracted with one or more recycling/disposal companies in each EU Member State, and this product should be disposed of or recycled through them. Further information on Thermo Electron's compliance with these Directives, the recyclers in your country, and information on Thermo Electron products which may assist the detection of substances subject to the RoHS Directive are available at www.thermo.com/WEEERoHS.

WEEE Konformität

Dieses Produkt muss die EU Waste Electrical & Electronic Equipment (WEEE) Richtlinie 2002/96/EC erfüllen. Das Produkt ist durch folgendes Symbol gekennzeichnet:



Thermo Electron hat Vereinbarungen getroffen mit Verwertungs-/Entsorgungsanlagen in allen EU-Mitgliederstaaten und dieses Produkt muss durch diese Firmen wiederverwertet oder entsorgt werden. Mehr Informationen über die Einhaltung dieser Anweisungen durch Thermo Electron, die Verwerter und Hinweise die Ihnen nützlich sein können, die Thermo Electron Produkte zu identifizieren, die unter diese RoHS Anweisung fallen, finden Sie unter www.thermo.com/WEEERoHS.

Conformité DEEE

Ce produit doit être conforme à la directive européenne (2002/96/EC) des Déchets d'Équipements Électriques et Électroniques (DEEE). Il est marqué par le symbole suivant:



Thermo Electron s'est associé avec une ou plusieurs compagnies de recyclage dans chaque état membre de l'union européenne et ce produit devrait être collecté ou recyclé par celles-ci. Davantage d'informations sur la conformité de Thermo Electron à ces directives, les recycleurs dans votre pays et les informations sur les produits Thermo Electron qui peuvent aider la détection des substances sujettes à la directive RoHS sont disponibles sur www.thermo.com/WEEERoHS.

Contents

Safety Information

Start-up Checklist

1 Introduction	1
About this Manual.....	1
Manual Conventions	1
Important Safety Precautions	2
About Degassing	3
2 Installation	5
Introduction.....	5
Unpacking.....	6
Controls and Indicators	7
Power-up	11
Solvent Lines	12
Multiple-solvent Connections	17
Degassing Efficiency	21
Priming.....	21
3 Operation	25
Introduction.....	25
Using the Vacuum Degasser	25
Using the Helium Degasser.....	26
4 Troubleshooting And Maintenance	27
Troubleshooting	27
Maintenance	29
Specifications (Vacuum Membrane Degasser)	32
Specifications (Solvent Helium Module).....	33
Spare Parts (Vacuum Membrane Degasser).....	34
Spare Parts (Solvent Helium Module)	35

Index

1

Introduction

About this Manual

This manual describes the Thermo Electron SCM1000 Vacuum Membrane Degasser. Included in this manual are instructions for connecting the degasser to Thermo Electron SpectraSYSTEM[®] pumps. This manual also contains instructions on maintenance and troubleshooting along with a list of consumable parts.

Manual Conventions

This manual uses several different icons to denote important information, notes and hints. The following five icons, each called out in the left margin, alert you to various situations.



CAUTION – RISK OF ELECTRIC SHOCK

This caution alerts you to the presence of high voltage and to the potential injury that could occur from electrical shock were you to come in contact with a specific instrument area or component. It also tells you how to avoid contact with the high-voltage areas in your instrument.



CAUTION

A caution alerts you to other situations that could result in personal injury. It also tell you how to avoid them. Cautions alert you to the correct operating or maintenance procedures needed to prevent equipment or data damage.



Hint

Hints call out general rules or shortcuts. They specify ways to obtain the best performance and results from your instrument.



Note

Notes alert you to important exceptions, side effects, or unexpected occurrences that may result from certain action(s).

Important Safety Precautions

Observe the following safety precautions whenever using the Vacuum degasser. The specific solvents you choose to use may require special handling. Pay close attention to all safety precautions listed for your solvents.



1. **CAUTION: Do not operate in an area containing flammable vapors or gases.**



2. **CAUTION: Whenever working on an LC system wear eye and skin protection.**



3. **CAUTION: When carrying the degasser, grasp it at both ends. The solvent bottle holder is not permanently attached to the degasser. Do not transport the degasser with the solvent bottles in the tray.**



4. **CAUTION: Do not remove the instrument's metal cover. There are no user-serviceable parts inside. Any servicing, beyond the routine maintenance described later, should be performed by a Thermo Electron Service Representative.**



5. **CAUTION: Do not degas ethers like tetrahydrofuran (THF) and other peroxidizable solvents in a vacuum membrane degasser. A protective nitrogen blanket is not maintained within the degasser. Small amounts of the solvents being degassed diffuse into the vacuum chambers where they mix with residual air. Accumulation of explosive peroxides is possible under these conditions.**

The degasser is designed to safely handle the popular eluants used in chromatography. Since mixing of diffused vapors occurs within the vacuum chambers, we warn against its use with incompatible fluids.

Toxic inhalation, ingestion, or explosion of vapors from solvents and/or samples can be avoided by taking sensible safety precautions. Store solvents in vented, fire-proof cabinets. Vent laboratory well to avoid accumulation of dangerous vapors. Handle all solvents and samples with care. Waste collection vessels should be larger than the total volume of the solvents and samples to be pumped through the system and should be covered. Wipe up spills quickly after they are properly neutralized. Always determine that there is no leakage of flammable solvents. Since ignition could occur without warning, keep fire extinguishers in close proximity to your HPLC system. Smoking and open flames near the instrument are prohibited. Wear eye, skin, and clothing safety protection at all times when working with harmful chemicals.

About Degassing

If dissolved gases are not removed from the eluant flow prior to the introduction of a chromatographic sample into the mobile phase, problems such as unstable flow through the pump, poor detector performance, reduced column life, and flow disturbances can adversely affect the quality of the chromatographic data you collect. These problems can be minimized or prevented with proper degassing techniques.

VACUUM DEGASSING

Compared to helium degassing techniques, vacuum degassing typically offers simpler set-up and operation. In addition, solvent loss through evaporation is minimized with vacuum degassing since there is no bubbling, as in helium degassing. Replenishing your solvent supply is also simplified, as there is no need to wait for sparging after filling the bottle.

Vacuum degassing is recommended for flow rates of up to 4.0 mL/min., (2-channel operation, pump-proportioned 50/50 methanol/water) or less. For higher flow rates, helium degassing is generally recommended, although higher flow rates can be achieved by degassing identical solvents, then T'ing together both solvents, routing them into the pump, and mixing them using solvent proportioning (gradient pumps). You can also briefly degas your solvent with helium, then route the solvent through the vacuum degasser. Flow rates as high as 6 mL/min. can be accommodated with this technique.

VACUUM DEGASSER

The Thermo Electron vacuum degasser can be used in conjunction with any liquid chromatography system. It uses the principle of on-line vacuum degassing to remove dissolved gases from common HPLC solvents. It contains four degassing systems, one for each outlet and inlet line pair, allowing multiple solvent degassing. The Thermo Electron vacuum degassing chemicals consists of multiple thin walled, tubular membrane surrounded by a vacuum chamber maintained at partial pressure. When the correct negative pressure (vacuum) is achieved in the chamber surrounding the membrane (80 - 100 mm Hg), dissolved gases diffuse through the membrane into the vacuum. Vacuum is maintained by a vacuum-control circuit and a vacuum pump. The vacuum pump continually operates to maintain the optimum vacuum. In addition, a secondary "in-line" check valve and solenoid valve seal the evacuated vacuum chamber from the pump to minimize load on the degasser motor during powerup while maintaining high vacuum over long periods. This design allows the degasser to power up and achieve the desired vacuum pressure easily and efficiently. The high vacuum and thin walled membranes provide efficient removal of dissolved gases.



NOTE: Note that the SCM1000 does not pump solvent through the degassing membrane.

HELIUM DEGASSING Degassing by sparging helium into a solvent, thereby forcing air out of the solvent, is a well-known and widely used degassing method. Helium sparging removes unwanted oxygen and nitrogen molecules from the mobile-phase solution as they equilibrate with the helium bubbles. Because helium has a very low solubility in LC solvents, helium sparging yields a nearly gas-free mobile-phase solution. Continuous sparging prevents the oxygen and nitrogen from redissolving into the mobile phase.

SOLVENT HELIUM MODULE The Thermo Electron Solvent Helium Module (SHM) consists of a helium manifold that contains two helium regulators and two on/off switches (one for each regulator). Helium from your source supply is connected with a “T” fitting to two helium inlet ports on the manifold. Helium flow to the spargers is adjusted using the regulator knob. The venting on/off switch provides a convenient way to turn off the supply of helium to the spargers without the need to adjust the regulator.

2 Installation

Introduction

This chapter describes how to install your SCM1000 Vacuum Degasser and your Solvent Helium Module. Installation instructions for the Solvent Helium Module are also included in *the SpectraSYSTEM Solvent Helium Module Reference Manual* (P/N A0099-506). SHM installation instructions are included in this manual should you want to sparge and then route your solvent(s) through your vacuum degasser.

Installing your degasser requires that you:

1. Carefully unpack your degasser;
2. Familiarize yourself with the degasser's controls and indicators (vacuum degasser only);
3. Turn on the instrument to verify that the power requirements are satisfied (vacuum degasser only);
4. Connect the solvent-inlet lines to the degasser and the solvent-outlet lines to the pump; and
5. Prime the degassing channels.

Unpacking

As you unpack your degasser, be sure all the parts are included. If anything is missing or damaged, contact your local Thermo Electron representative immediately.

SCM1000 VACUUM DEGASSER

Verify that you received the following:

Degasser and bottle holder (tray)

Accessory Kit (P/N 803055)

- 8 Tefzel[®] ferrule for 1/8" tubing
- 8 Standard 1/4"-28 (natural polypropylene) union
- 4 Flangeless 1/4" polypropylene nut
- 1 Power cord

SCM1000 Vacuum Degasser Reference Manual (P/N A0099-509)

SOLVENT HELIUM MODULE

Your kit consists of the parts listed below. If you ordered the Four-solvent Helium Degassing Kit, you should have received a double supply of the asterisked (*) parts required to install the second helium manifold.

- *1 Helium valve/switch manifold containing two valves and two switches, assembled (P/N A4126-020)
- 1 11-3/16 inch steel rod (P/N A3965-010)
- 1 8-1/2 inch steel rod (P/N A3965-020)
- 2 Bracket ends (P/N A3963-010)
- 2 Phillips screws (P/N 7111-0607)
- *2 Dual Lock[®] reclosable fasteners (mounting strips), (P/N 2509-6986)
- 1 Allen wrench (Hex head, 1/16-inch) (P/N 5401-0030)
- 1 Helium manifold label kit (no separate part number)
- 1 Tefzel[®] Tee, 1/4-28 (Four-solvent Degasser Kit only) (P/N 2522-0278)
- *2 Cheminert[®] unions (no separate part number)
- 1 Solvent bottle holder (not included with the Helium Degassing Bracket Kit)
- *1 Packet of 2 stainless steel sparger tubes (A4118-010)
- *2 Inert sparger (A4135-010)
- 1 *SpectraSYSTEM Solvent Helium Module Reference Manual*

Controls and Indicators

Before installing your vacuum degasser, refer to Figures 2.1 and 2.2 for the locations of the power switch and indicators.

Front Panel LED Indicators	Three front panel LEDs provide Power, Run and Ready status information, see Fig. 2:1
Solvent Leak Detector	If liquid enters the vacuum lines, the Power LED blinks, and the vacuum pump operation automatically stops.
Solvent Inlet Lines (A, B, C, D - IN)	These lines connect the SCM1000 to the solvent reservoirs. Each 1/8" OD line is approximately 36 inches long and is permanently connected directly to the tubular membrane.
Solvent Outlet Lines (A, B, C, D - OUT)	These lines connect the degasser to the HPLC pump and are similar to the solvent-inlet lines described above.
AC Power Switch	Two-position on/off switch on the rear panel switches incoming power to all electrical components.
Fuse Holder (Fuse)	The main power fuses are located in the fuse compartment above the power switch on the rear panel.

Figures 2.1, 2.2, and 2.3 illustrate the front, rear, and top views of your degasser.

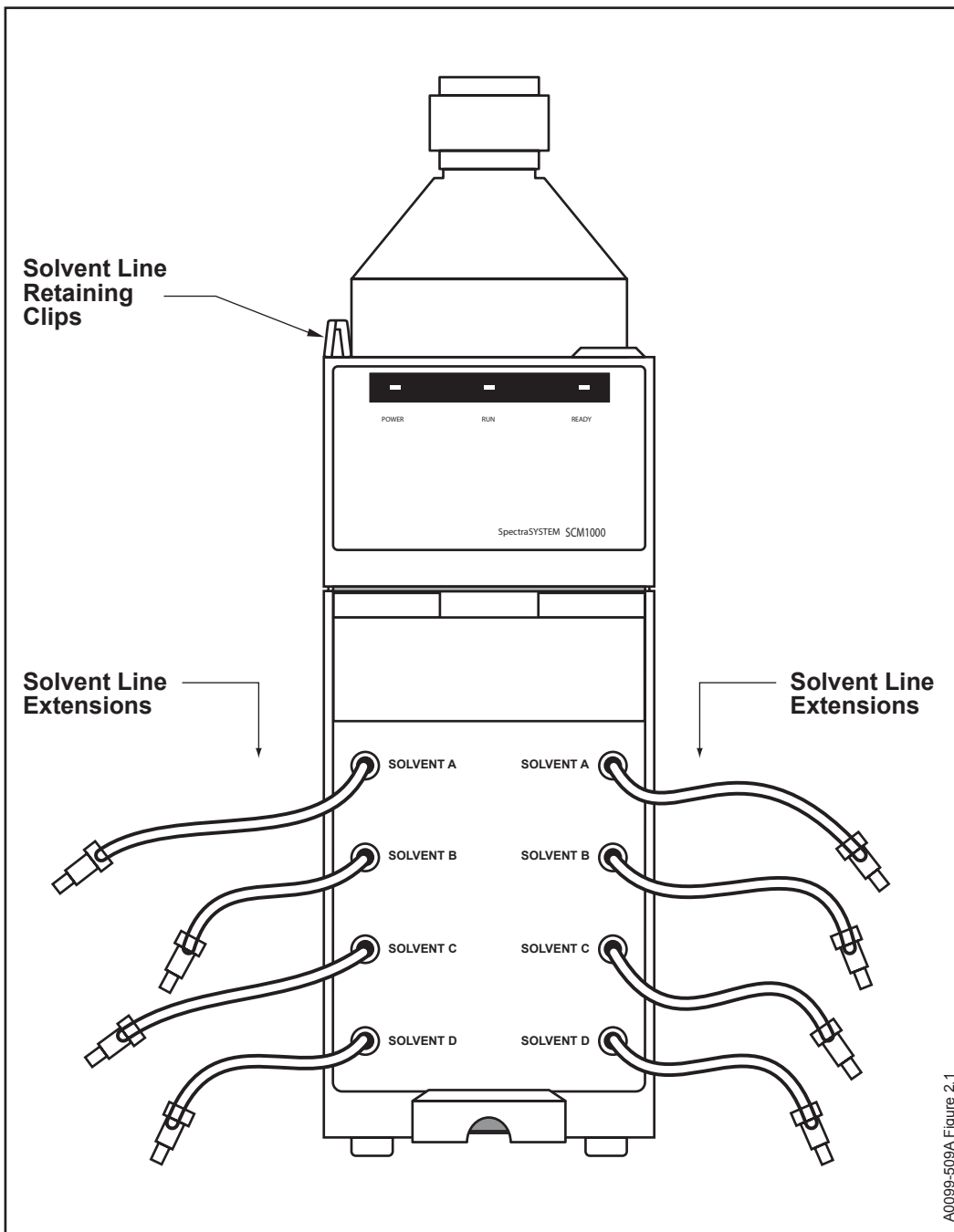

A0099-509A Figure 2.1

Figure 2.1 Vacuum degasser front panel

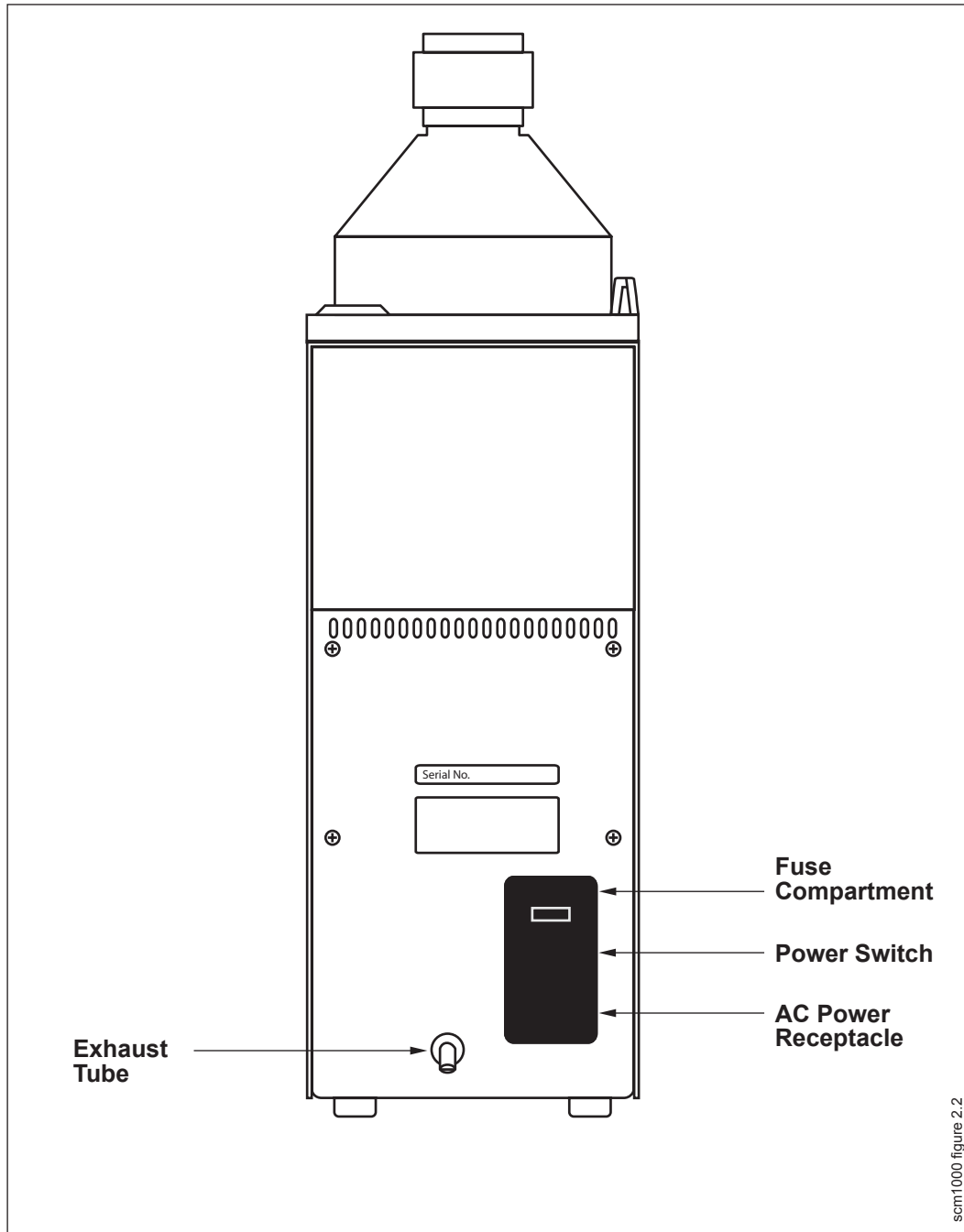

scm1000 figure 2.2

Figure 2.2 Rear panel

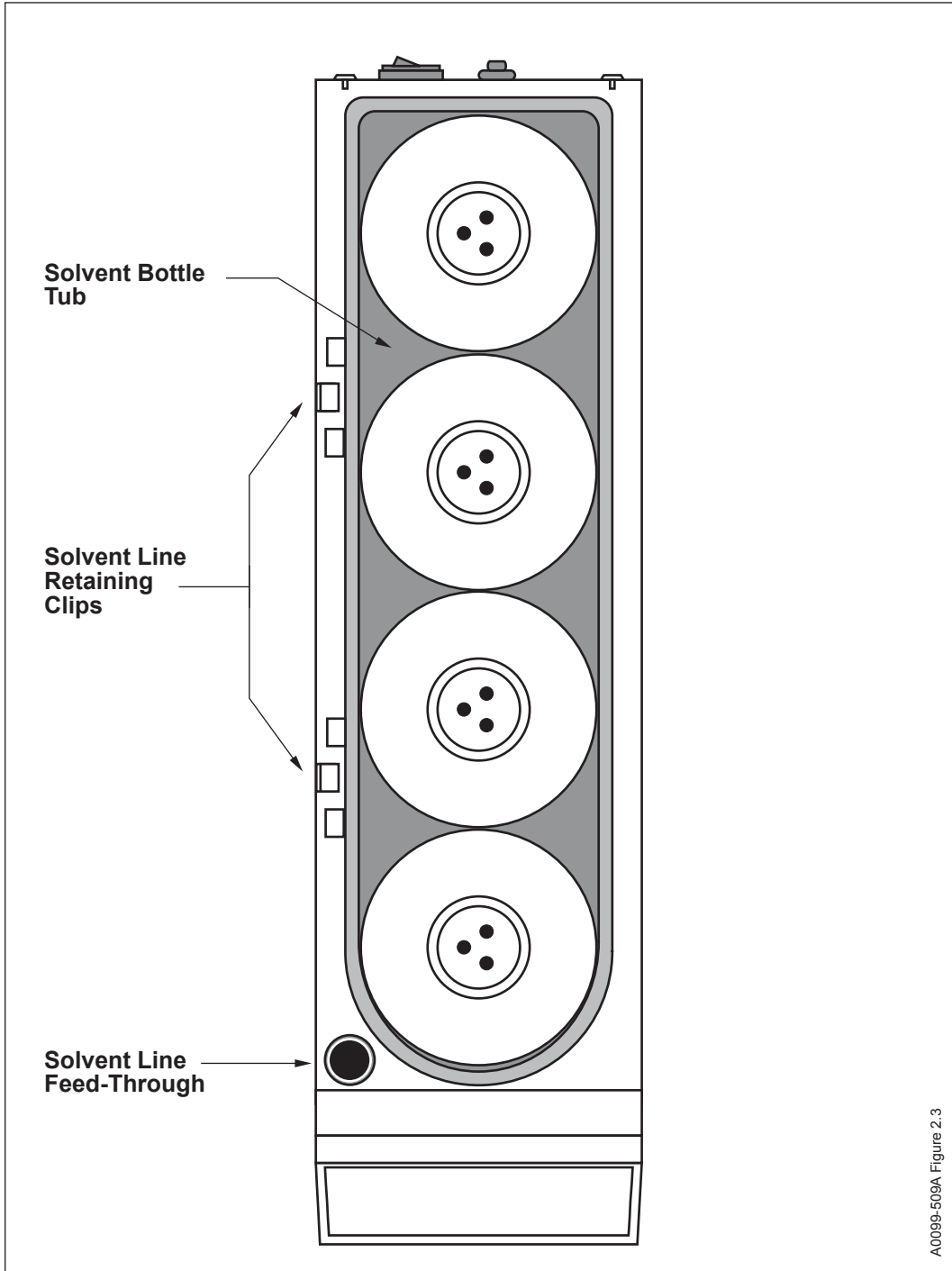

A0099-509A Figure 2.3

Figure 2.3 Top view

Power-up

Put the degasser on a level surface with at least 2 cm clearance in the back. Place the degasser on either side of the pump such that a minimum of tubing is needed to connect to the pump.

Before making the solvent connections, turn on the degasser to verify that the electrical connections are made.

1. Plug the instrument into a properly grounded (3-wire) power outlet and press the power switch (Fig. 2.2).
2. Check front panel for correct operation; All three LEDs lights will turn on at power up for 1 second. Then, the power LED will remain on.
3. The Run LED light turns on as the vacuum pump evacuates the vacuum chambers.
4. The Ready LED light turns on when the proper vacuum is reached.
5. The following error conditions might occur:
 - If the vacuum rises above 80 mm Hg, the Power LED turns off and the Run LED blinks.
 - If the vacuum does not reach 54mm Hg in 10 min, the Power LED blinks.
 - If the vacuum rises more than 5 mm Hg in 15 min, the Run LED blinks.
 - If a vacuum of less than 54 mm Hg is not reached, the Ready LED turns off.



NOTE: Without liquid in the solvent lines, you will see a slow vacuum loss (approximately 0.4 in. Hg/hr) as room air diffuses across the membrane into the vacuum.

Solvent Lines

Both degassing systems accommodate up to four 1L bottles and use standard cap and tubing assemblies. Inlet and outlet tubing is included. Bottles, caps, and tubing extension kits for use with larger solvent bottles may be purchased separately. For specific part numbers and ordering information, refer to the Spare Parts and Accessories List at the end of this manual.

VACUUM DEGASSER

When shipped, the degasser's tubing may contain a small amount of an isopropyl alcohol-distilled water solution. Be sure that the first filtered, HPLC-grade solvent you use is miscible with water. For each solvent:

1. Insert the solvent inlet and vent tubing into the bottle cap.
2. Fill the bottle(s) with solvent, cap, and place in tub. Be sure that the solvent line extends well into the solvent and that the vent tube remains above the liquid level at all times.



NOTE: If you are using larger solvent bottles and you purchased extension tubing with your degasser, connect the extension tubing to your own bottles and caps. Be sure to label your bottles.

3. Slip the inlet tubing slack under the retaining hooks on the top, left edge the solvent tub.



CAUTION: If you intend to use helium sparging in conjunction with vacuum degassing, remove the cap plug and insert the helium sparge line. A short piece of tubing should already be in the third hole to serve as a vent. Do not allow the vent tube to contact the solvent.



CAUTION: Never do helium sparging with all cap holes plugged unless you have a 5 psi head pressure on your solvent bottle(s), or pump cavitation will result.

2. Open the front panel by grasping the bottom of the front panel, and pulling forward. Remove the protective caps on the inlet and adjacent outlet lines that you plan to use.
3. For each solvent, thread the free end of the inlet tubing up through the access hole in the top, left side of the solvent tray lip (Fig. 2.3), and then slide into the tube retaining clips along the left side of the solvent tray if present.
4. Connect the end of the inlet tubing to an inlet line extension and finger tighten.



HINT: For easier priming, fill the inlet tubing with solvent before attaching it to the degasser. (You can attach a syringe to the end of the inlet tubing and pull solvent from the bottle. See page 26.)



NOTE: The inlet/outlet pairs are bi-directional. If it is more convenient to route the solvent in on the right side, and out on the left, you may do so for any inlet/outlet pair.

5. Connect the end of the outlet tubing to the pump inlet with the corresponding letter.



CAUTION: In a well ventilated laboratory, the vacuum degasser can safely degas the eluants commonly used in liquid chromatography. However, as an added precaution, you can connect the exhaust port (see Figure 2.2 on page 9) on the rear of the degasser to an external vent.

SOLVENT HELIUM MODULE

The steps below describe how to attach the helium manifold to the side of the vacuum degasser and connect the helium lines to the manifold and solvent bottles. As you install the helium module, make certain that all solvent tube connections are tight.



NOTE: For information on attaching the helium manifold and routing your sparged solvents directly to the pump, refer to the SpectraSYSTEM Solvent Helium Module Reference Manual.

Tools

The following tools may be required for installation:

1. Phillips screwdriver
2. Allen wrench (included in the accessory kit)

Installing the Helium Manifold(s)

To mount the helium manifold, first locate the two stainless steel rods from your SHM accessory kit. Use the short rod if you are mounting your helium manifold to the SHM. Use the long rod if you are mounting your helium manifold to a SpectraSYSTEM or SpectraSERIES pump.

1. Slide the rod into the manifold(s) and through the slot on the right side of the manifold. Make sure that the grooved edge of the rod is facing you as you look at the front of the manifold.
2. Using an Allen wrench, tighten the manifold(s) into position on the rod by tightening the two small set screws, located on the face of each manifold.
3. Unscrew and remove the two screws on the side of the pump, degasser, or SHM using a Phillips screwdriver. Typically the other instruments in your system would be positioned to the right, so that the helium bracket and manifold(s) would be attached to the left-hand side of unit.
4. Place a bracket holder over each end of the rod.
5. Position the flat side of the bracket holders over the holes exposed in step 3.
6. Fasten the rod to the module using the two Phillips screws provided with the SHM.

When installed, your helium bracket and manifold will look similar to Figure 2.4.

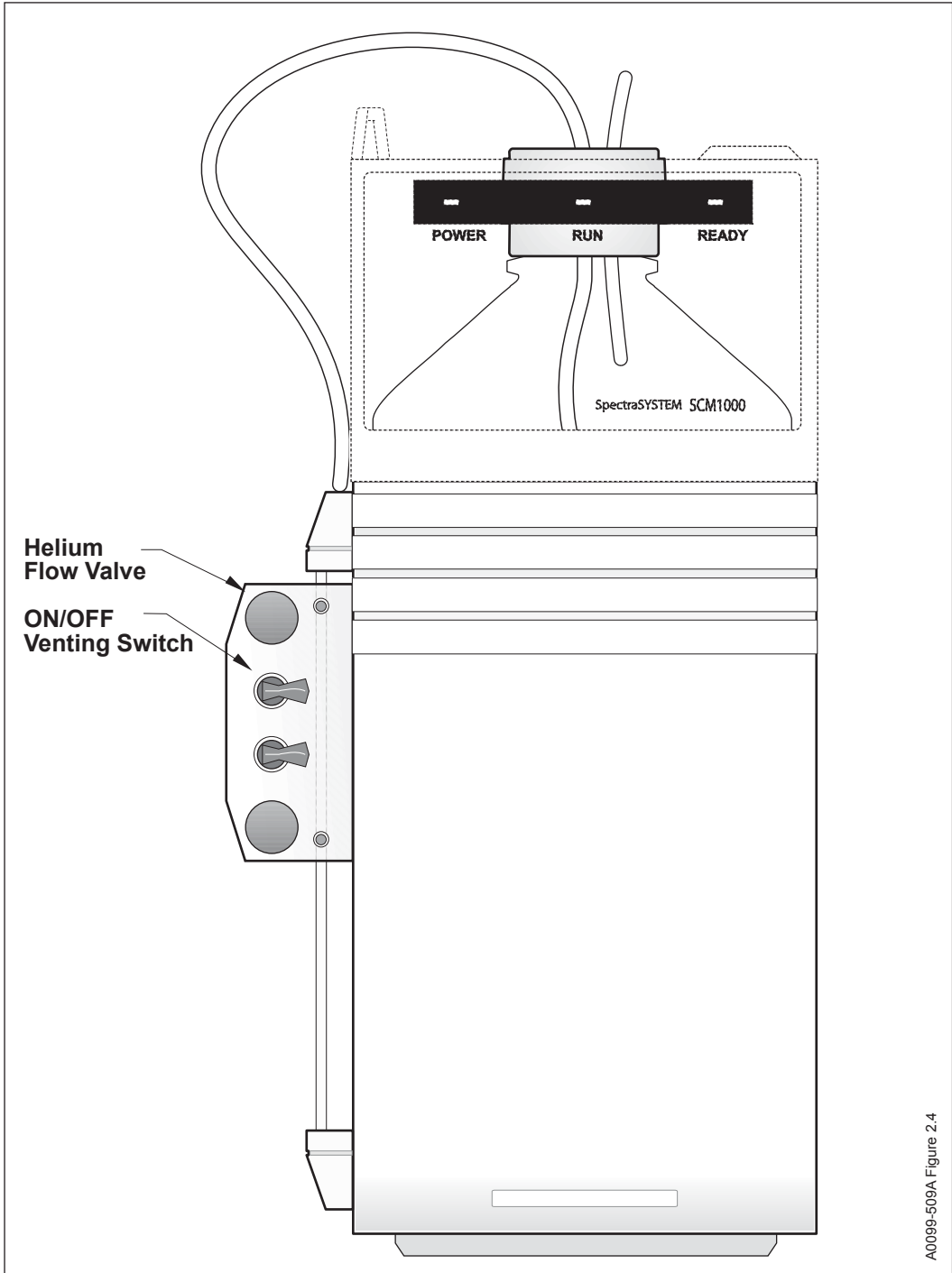

Figure 2.4 SHM with helium bracket and manifold installed
NOTE: A second helium manifold allows 4-channel helium sparging.

Connecting the Solvent Lines

The steps below describe how to set up the solvent bottles and make connections to the helium valve/switch manifold. Refer to Figure 2.5.

Solvent Bottles

If you have not already done so, prepare your solvent bottles. You may use the bottle caps available from Thermo Electron. First remove the cap plug, then unscrew the sparger from the end of the sparger tube (P/N A4118-010) provided in your Accessory Kit. Insert the sparger tube through the cap until it is the same length as the filter tube. Replace the sparger. If you have an inert biocompatible pump, you may want to use an inert sparger (P/N A4135-010). Once you have capped the bottle, verify that the sparger and filter extend to or close to the bottom of the bottle, and be sure that the vent tube does not extend into the solvent.

Valve/Switch Manifold

Each manifold has two sets of flow valves and On/Off switches. Each valve/switch set provides helium to one solvent bottle. The helium manifold configuration provides helium for up to two solvent bottles.

To make connections to the valve/switch manifold:

1. Connect helium from your helium supply to the tubing that T's into the two inlet ports on the back of the manifold (Fig. 2.6).
2. Connect the free ends of two sparger tubes to the helium outlets. Repeat if you have four-solvent degassing.
3. If not pre-attached by the factory, attach self-adhesive labels to the regulator valve knob caps to help you identify the connections.
4. Ensure that the switches are in the Off position (right).
5. Turn on the helium supply from your helium source regulated at 10-15 psi. You should not need to set your regulator higher than 15 psi for adequate sparging.



NOTE: If you are using your helium line for other than sparging, you can set the pressure up to 100 psi. However, this may make it difficult to regulate helium sparging.



CAUTION: Never close the helium flow valve knob tightly. You will irreparably damage the manifold.

6. Open the flow valves by turning the knobs counter-clockwise.
7. Flip the switches to the On position (left).
8. Adjust the helium supply to the spargers using the flow valve knobs until you are satisfied with the helium flow. When the vent tube is immersed in liquid, bubbles should emerge, indicating positive pressure within the solvent bottle.



CAUTION: Whenever you close the helium flow valve knob, be sure to also flip the switch to the Off position, so that the valve will vent to atmosphere. Failing to flip the switch to Off will cause solvent to siphon into the helium tubing, possibly damaging the flow valve and switch and/or contaminating your solvent.

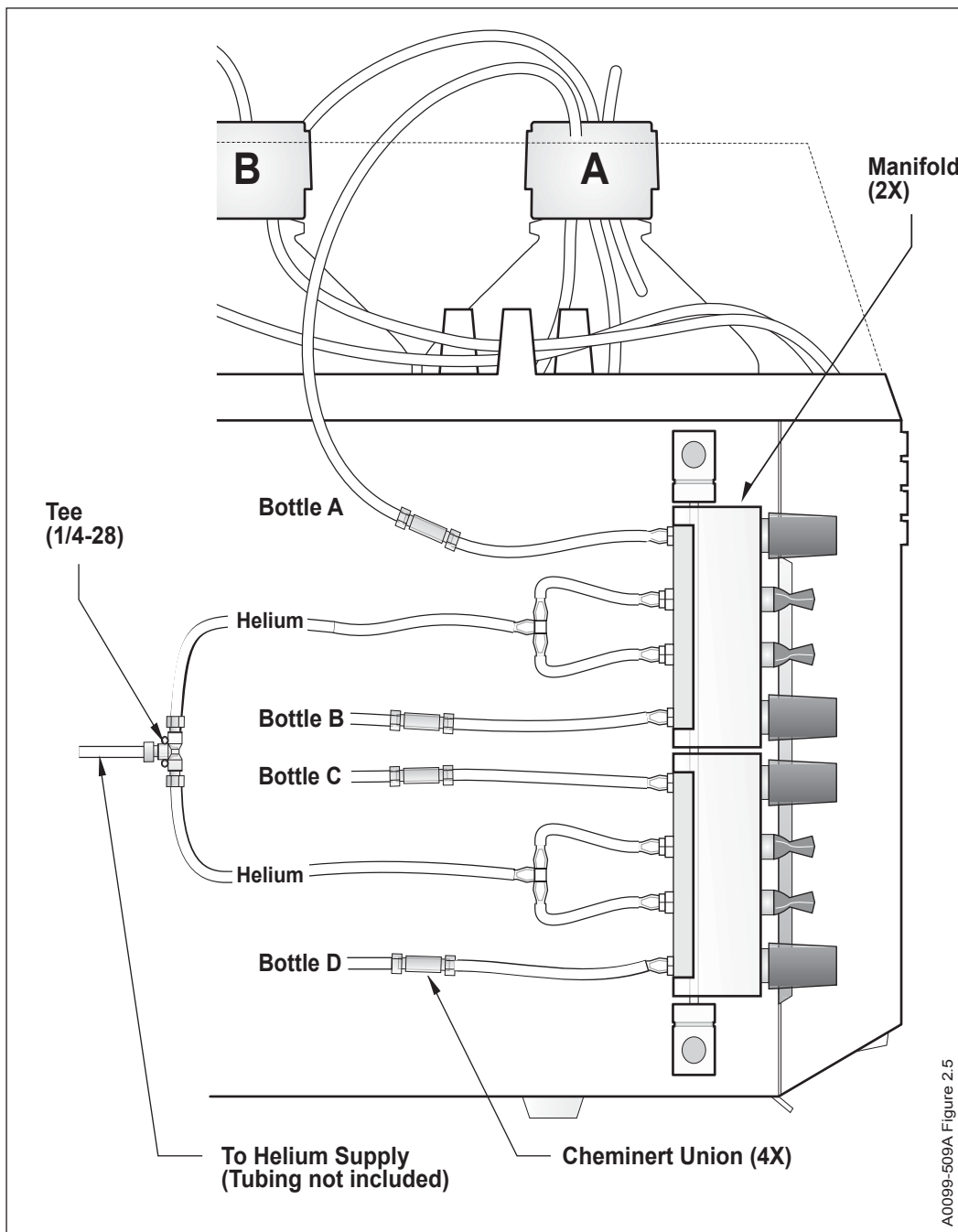

Figure 2.5 Helium supplied to valves and from valves to spargers, 4-channel configuration

Multiple-solvent Connections

To route solvents from the vacuum degasser to the pump, connect each vacuum degasser solvent IN line to the appropriate reservoir bottle. Connect each solvent OUT line to the pump-inlet valve with the same letter. The solvent-inlet lines should be equipped with a valve for safety and convenience. (Refer to the Spare Parts and Accessories List, page 34, for Thermo Electron valves.) Close the valve(s) when the degasser is not in use.



NOTE: The inlet/outlet pairs are bi-directional. If it is more convenient for you to route undegassed solvent in on the right side and degassed solvent out on the left, you may do so for any inlet/outlet pair.

High flow rates can be achieved in two ways:

- By using identical solvents in more than one channel, and joining (T'ing) the solvent outlet lines together before they enter the pump
- By connecting the outputs directly to a quaternary pump, and then adjusting solvent compositions as needed

Figures 2.6, 2.7, and 2.8 illustrate typical degasser-to-pump connections.

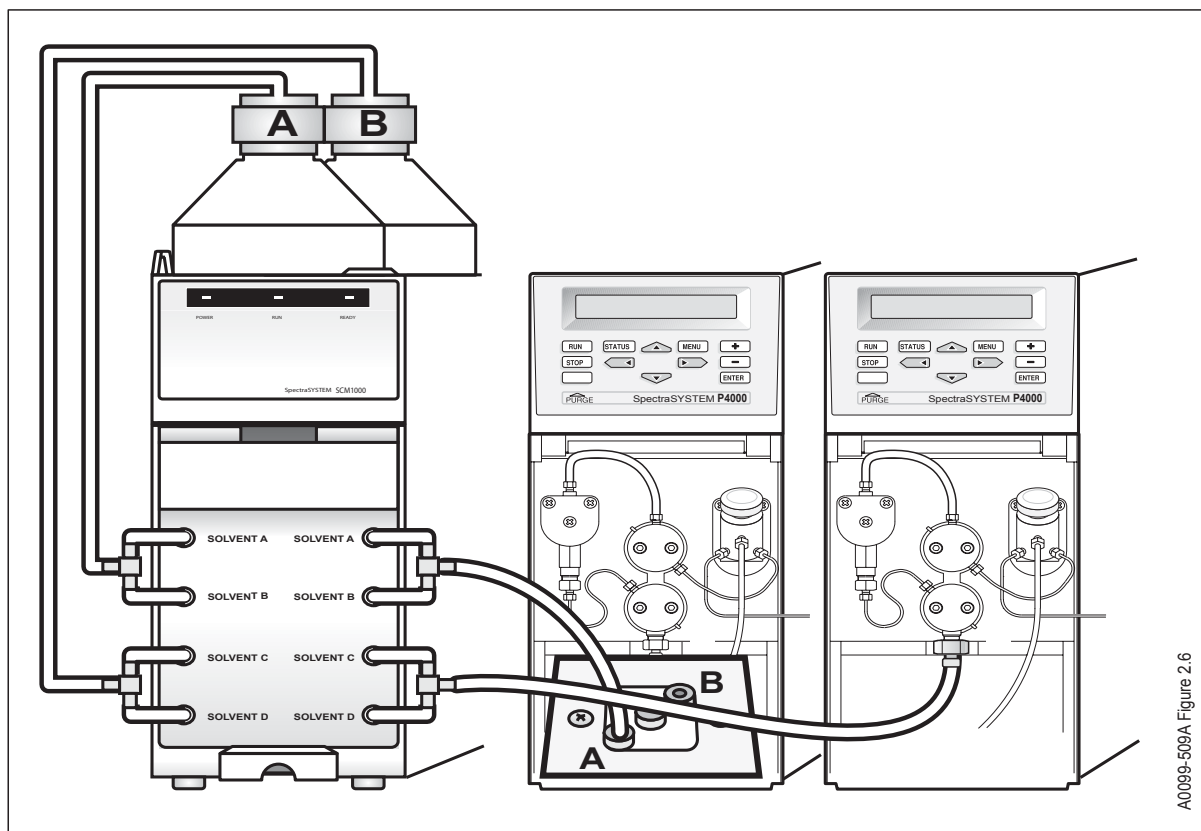

A0099-509A Figure 2.6

Figure 2.6 Typical 2-solvent system connections

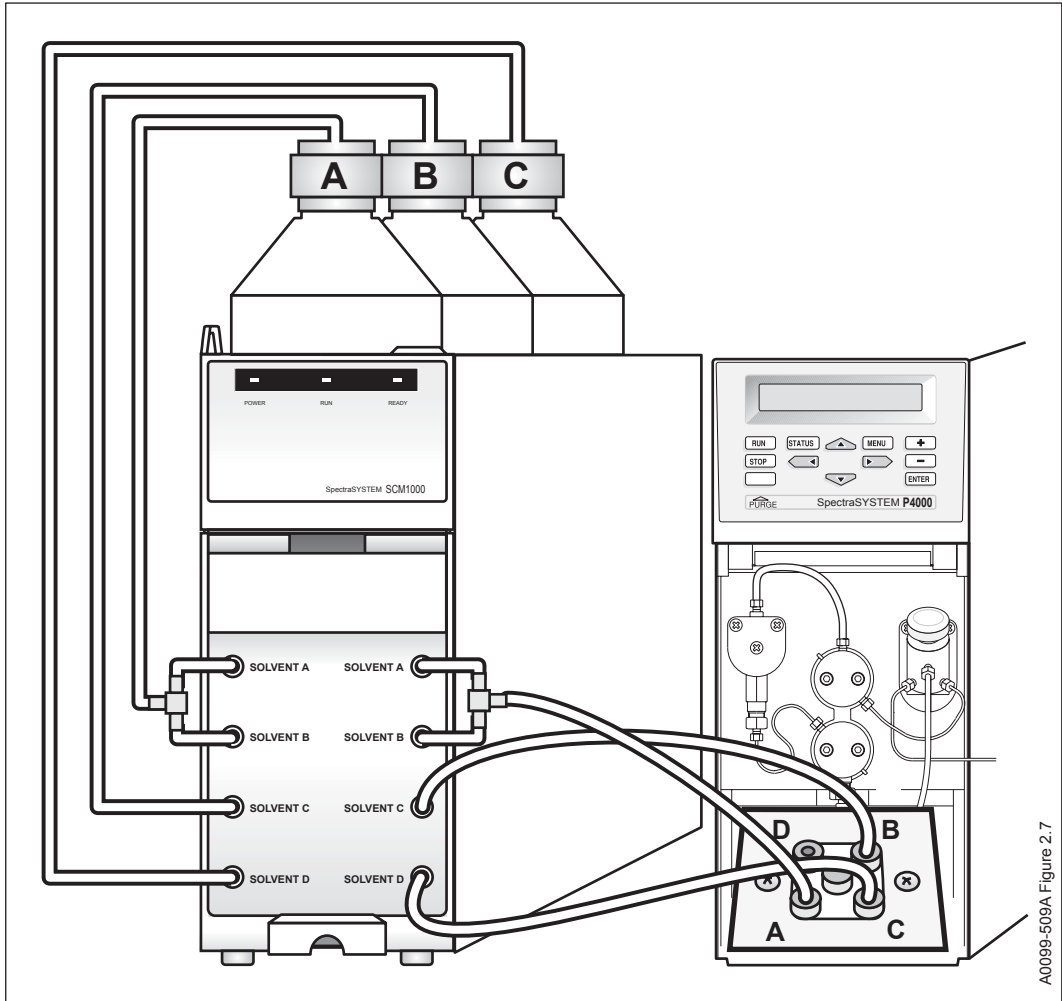

A0099-509A Figure 2.7

Figure 2.7 Typical 3-solvent system connections

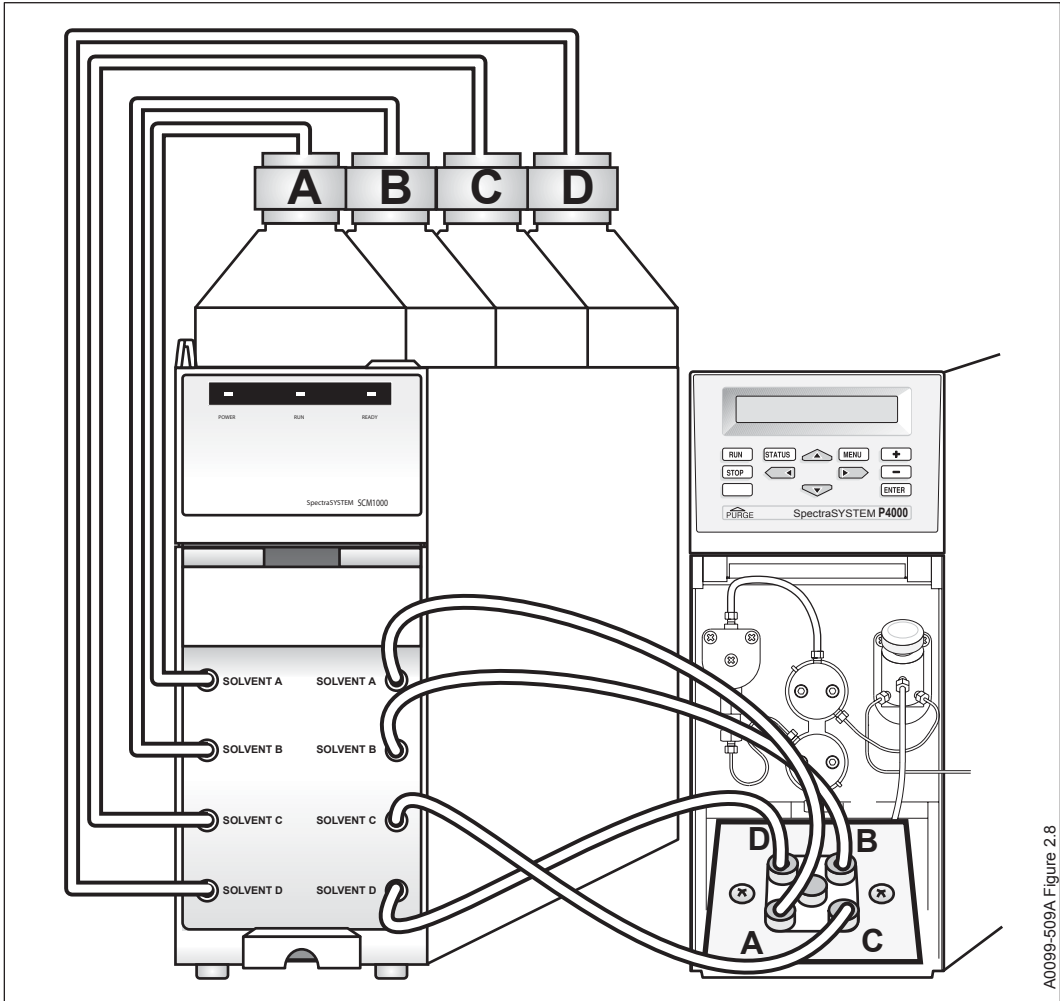

A0099-509A Figure 2.8

Figure 2.8 Typical 4-solvent system connections

Degassing Efficiency

The longer a solvent is in contact with the membrane, the more chance it has to reach equilibrium with the operating vacuum.

If you plan to use a particular solvent at a flow rate above 1 mL/min., you may consider a parallel flow arrangement (Fig. 2.6). With this arrangement you connect two solvent IN lines to the same reservoir with a Tee connector. A second Tee connector is used to join the two corresponding solvent OUT lines to the HPLC pump. This arrangement doubles the amount of membrane available and decreases the flow resistance. If you generally work with three or fewer eluants, it is an advantage to connect at least one set in parallel (Fig. 2.7).

It is recommended that solvents with high gas solubility (i.e. Hexane, methanol), be run in parallel. A parallel flow arrangement also provides the best results when flow rates are greater than 2 mL/min. at a head press of 2 feet. High flow rates tend to “starve” the pump of solvent due to the resistance through the membrane tubing.

Studies at our facility using the SCM1000 indicate that it is very efficient at removing dissolved air from water. Therefore, water should not be considered for parallel flow strictly from a need to remove its dissolved air. Methanol and hexane, with their large capacity to dissolve air, are a good choice for parallel flow configuration.

Priming

Follow the steps below to ensure that the tubing is filled with solvent before attaching to a pump and turning on the degasser.

To initially fill the lines with solvent, use the HPLC pump’s prime purge valve feature or pull the solvent through with a large syringe using the steps below.

Purge Method

Immediately after you prime the degasser, you will need to connect the solvent to your pump. To prime the degassing lines using the pump’s purge function, connect the solvent OUT line to the pump-inlet valve with the same letter. If you are using a SpectraSYSTEM pump, be sure the bypass valve is opened, and then Press PURGE.

Since pumps differ, the locknut provided to connect the degasser to the pump might not fit. You may need a special connector to provide a secure connection between the degasser's outlet and your pump's inlet. Check the compatibility of the degasser's outlet with your pump inlet tubing. If you are not able to use the supplied connector, obtain the proper connector before proceeding.

Syringe Method

To prime the degassing lines using the syringe method, you'll pull solvents through the tubing with a syringe.



CAUTION: Be sure that you have at least 19" of vacuum, or the membrane could collapse from the suction during priming.



NOTE: Never push solvents through tubing; always draw (pull) solvents through the tubing.

1. Screw the supplied luer fitting into the outlet line and finger-tighten. Attach the syringe to the luer fitting, making a leak-free connection (Fig. 2.9).

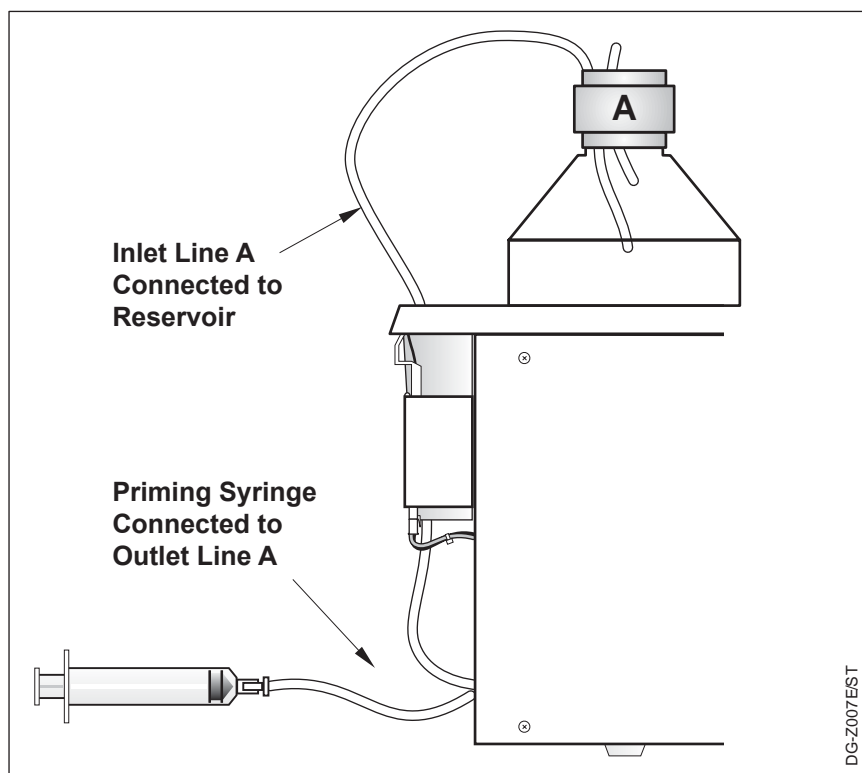

Figure 2.9 Syringe attached to chamber's outlet line

2. Slowly withdraw the syringe plunger so that air is drawn out of the degasser. Wait several seconds. Remove the syringe and dispense any air and solvent into a waste container. Reconnect the syringe and again, slowly withdraw the plunger.
3. Each degassing channel holds 12 mL \pm 2 of solvent. Continue to slowly draw air until solvent is drawn from the bottle into the inlet line and finally, out of the outlet line and into the syringe. Continue to draw solvent until you are sure that the tubing is full of solvent and that there are no air bubbles in the solvent being drawn out. Remove and empty the syringe into a solvent waste container as often as necessary.
4. Remove the luer fitting and immediately connect your pump's inlet tubing to the degasser outlet. Tighten the locknut to finger-tight (Fig. 2.10). A small amount of solvent may spill from the degasser's outlet as you connect the pump's tubing.



NOTE: Since pumps differ, the locknut provided may not fit. You may need a special connector to provide a secure connection between the degasser's outlet and your pump's inlet. If you are not able to use the supplied connector, stop now. Obtain the proper connector before proceeding.

5. Repeat steps 1-4 for each solvent.

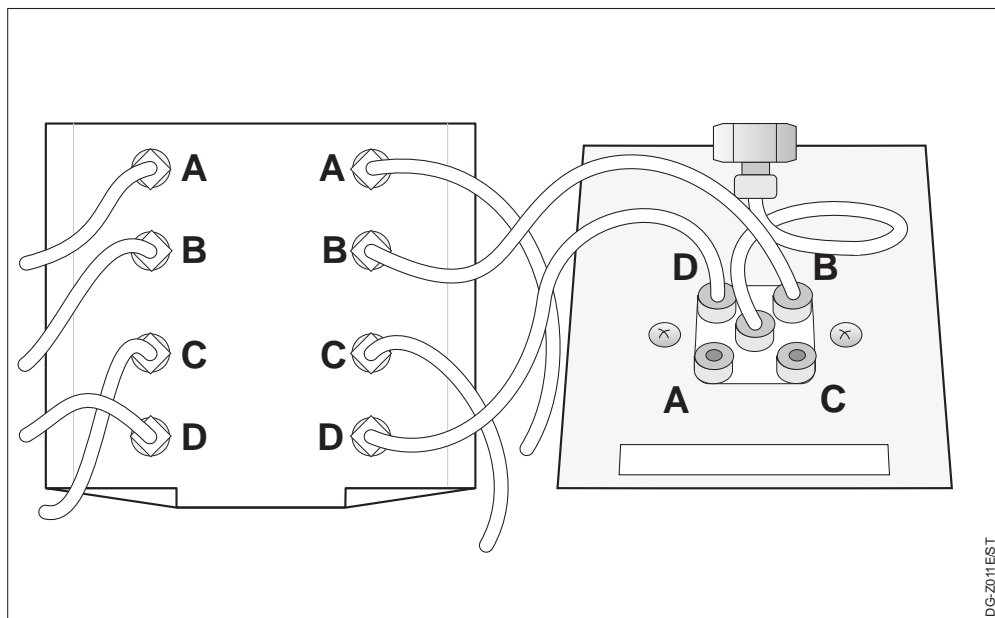

Figure 2.10 Example of a solvent connection from the degasser to a P4000 Pump

6. Carefully replace the degasser's front panel. The degasser is now ready to degas solvents.



HINT: Outlet tubing connected to a pump can be routed through slots in either side of the front panel.

The first time you use the vacuum degasser, some undegassed solvent will be present in the outlet line. To prevent unwanted gases from reaching your pump, we recommend that you run a small amount of each solvent through the pump before connecting the mobile phase to your injector or autosampler. (In a SpectraSYSTEM pump, RUN or PURGE with the bypass valve open.)

Keep unused channels capped, or jumpered using a short piece of tubing, to prevent contamination of the inside of the degas tubing.



NOTE: Due to the added flow resistance, we do not recommend routing the solvent from the outlet of one channel into the inlet of another.

3 Operation

Introduction

This chapter describes how to use your vacuum membrane degasser.

Using the Vacuum Degasser

The flow rate of the solvent through the degassing apparatus affects the efficiency of dissolved gas removal. The slower the flow rate, the more gas removed.

The solvent flow rate is changed by varying the pump's flow rate. A flow rate of 4.0 mL/min. maximum for a composition of water and methanol (up to 50% methanol), mixed in a SpectraSYSTEM pump, produces reliable, reproducible pump performance. Acetonitrile-water mixtures and pre-mixed solvents can be run at higher flow rates since these are less likely to cause bubbles when mixed inside the pump. If all four solvent lines are in use, the maximum recommended flow rate, combined, for the most difficult solvent mixture (methanol-water) is 6 mL/min.

TO DEGAS SOLVENTS

Using the vacuum degasser is simple:

1. Turn on the degasser. The power switch is located on the back panel of the degasser. See Figure 2-2 on page 9.
2. Begin solvent flow through your LC pump.



HINT: If you do not regularly use all four vacuum channels, occasionally draw a frequently used solvent into a normally unused channel to extend the degasser's overall lifetime.

If the solvent supply is low, simply add more solvent directly to the bottle. There is no need to turn the degasser off, or to interrupt your run.

Using the Helium Degasser

During the installation procedure you should have adjusted the helium flow from your source to the spargers, using the regulator valve knobs. In everyday use, you should not need to adjust the regulator(s).



CAUTION: Never close the helium regulator knob tightly. You will irreparably damage the regulator.

To initiate sparging, simply flip the switch to the "On" position (left). To stop sparging, flip the switch to the "Off" position (right). The switch has been designed to vent to atmospheric pressure. This eliminates the possibility of solvent being drawn into the sparge tubing.



CAUTION: Whenever you close the helium regulator knob, be sure to also flip the switch to the Off position, so that the valve will vent to atmosphere. Failing to flip the switch off will siphon solvent into the helium tubing, possibly damaging the regulator valve and switch.

4 Troubleshooting and Maintenance

Troubleshooting

If you encounter any problems with the SCM1000 Vacuum Degasser, refer to this troubleshooting guide. To troubleshoot the Solvent Helium Module, refer to your Solvent Helium Module Reference Manual (P/N A0099-506). If the problem persists after you have tried the solutions suggested, contact your Thermo Electron Service Representative.

TABLE 4.1 TROUBLESHOOTING THE SCM1000

SYMPTOM	PROBLEM	SOLUTION
1. Solvent not being delivered from outlet line.	a) Solvent filter dirty or not present.	a) Replace.
	b) Bubbles or obstructions in outlet line.	b) Test flow using a syringe.
	c) Inlet line improperly connected.	c) Reconnect properly.
	d) Insufficient solvent in the solvent bottle.	d) Replenish solvent bottle.
2. Vacuum gradually decreases.	a) A gradual decrease (approximately 0.25 in. Hg/hr) is normal when degassing solvents that contain much dissolved air.	a) Be sure that all unused solvent lines are filled with a 50:50 methanol-water solution or are tightly capped.
3. Degasser's vacuum pump hums, but will not run.	a) Incorrect or low power line voltage.	a) Verify proper line voltage and power line conditions.

- | | | |
|--|--|---|
| 4. Small bubbles continue to enter the degasser. | a) Loose or faulty reservoir connector.

b) Dirty solvent filter.
c) Flow rate too high for degasser to work efficiently.
d) Fittings overtightened from repeated use. | a) Tighten connector. Be sure that ferrule is oriented correctly and tightened sufficiently. Note that plastic ferrules may orient in the opposite way from metal ferrules.

b) Replace.
c) Use a parallel flow arrangement.
d) Replace fittings. |
| 5. Instrument does not turn on. | a) Blown fuse. | a) Replace. |
| 6. Power On light blinking | a) Possible vacuum leak
b) Power line problem | a) Check lines
b) Check proper line voltage. |
| 7. Run light blinking | a) Possible vacuum leak | a) Check lines
b) Replace vacuum chamber |

INTERNAL SOLVENT LEAK

Should solvent leak into the vacuum system, the Power LED on the front of the degasser will blink. In the event of a leak, the leak detector circuit will prevent the vacuum pump and solenoid valve from operating, thereby trapping solvent in the lines. If the Power LED blinks, do the following:

1. Check for a false alarm:
 - a. Turn the instrument off and then back on to reset the leak detector.
 - b. Start the degasser. If the degasser pump runs normally, a false alarm may have been triggered by a spike or fluctuation. Watch for a repeat alarm. If an alarm recurs, proceed to step 2.
2. Turn off the main power switch, unplug the instrument, and remove the power cord.
3. To stop the leak, close the solvent valves between the reservoir (bottle) and the degasser (if installed).
4. Remove the solvent line from each reservoir. Open any in-line valves and note which solvent is being drawn into the vacuum. (You will see a bubble moving through the tubing.)

5. Contact our Customer Service Department for repairs.



CAUTION: If a leak occurs, call customer service immediately. Allowing solvent to remain in the vacuum system overnight could soften the plastic (PVC) vacuum tanks and cause an internal leak and instrument damage.

Maintenance

TIPS

To keep your degasser in optimum working condition, we suggest you check the following each day:

1. Are fittings and tube connections tight?
2. Do you have sufficient solvent for the anticipated run time?
3. Is the flow of solvent inside the inlet and outlet tubing restricted?

Occasionally check the solvent tray and clean it of spilled solvents as necessary. To do this:

1. Remove solvent bottles from the tray.
2. Remove the solvent tray from the instrument chassis. Clean as necessary, and return.
3. Return solvent bottles to the tray.

CHANGING SOLVENTS

You may occasionally want to change the solvent flowing through a particular channel. Depending on the last solvent used, and the solvent you are planning to use, you will need to flush the degas tubing with one or more intermediary solvents.

Follow the steps below to change solvents.

1. Turn off the degasser.
2. Remove the bottle cap and pull out the inlet tubing of the solvent you no longer wish to use.
3. If desired, allow approximately 10 mL of air to be introduced into the tubing. (This separates the new solvent from the previous solvent.)
4. Replace the cap and tubing inside the new bottle of solvent.
5. Pump approximately 40 mL of solvent through the degasser (to eliminate any air introduced into the tubing).
6. Turn the degasser back on and proceed as usual.

Alternately, you can attach a syringe to an outlet tube, and pull all the solvent out of the degasser with the syringe. Once the solvent is removed, prime the tubing with a new solvent as described on page 21.



CAUTION: Do not apply suction if the indicated vacuum is less than 19" Hg, or the membrane tubing may collapse.

CHANGING THE FUSES

The degasser requires T1A fuse for all models. The fuse compartment (Figure 4.1) holds either size fuse. To change the fuses:

1. Unplug and remove the power cord.
2. Use a small, flat-head screwdriver to pry open the fuse compartment (Fig. 4.1).

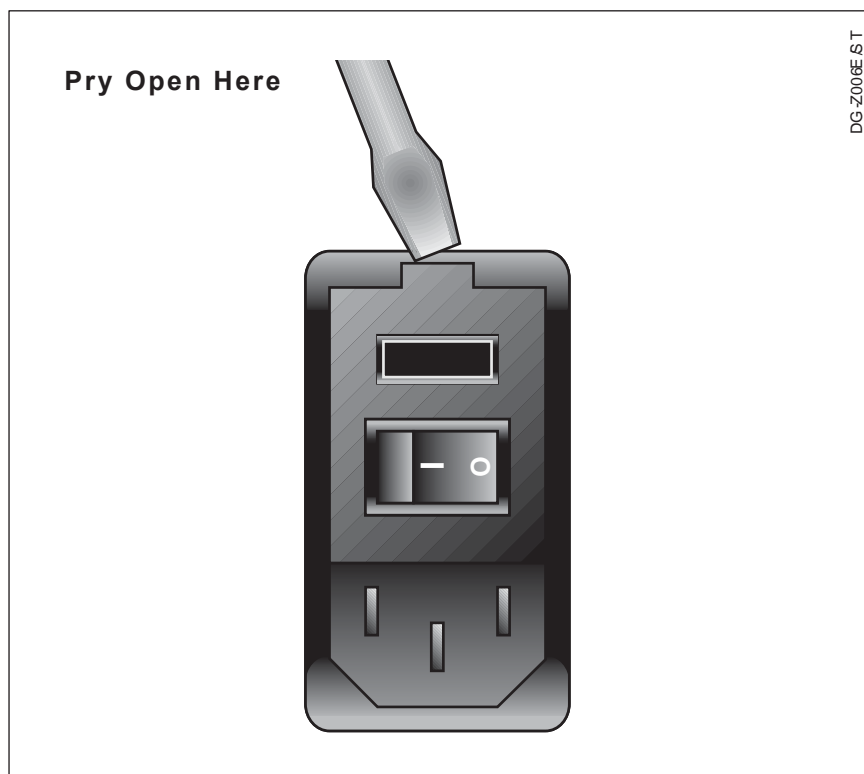

Figure 4.1 Fuse compartment

3. Pull the fuse holder out of the compartment.
4. Remove the used fuses and discard.
5. Replace the proper size fuse into the holder. Be sure that the end of the fuse is in contact with the end of the cartridge so that the proper electrical connection is made (Fig. 4.2).
7. Re-install the holder in the compartment, and snap the compartment cover closed.
8. Reinstall the power cord and plug in the degasser.

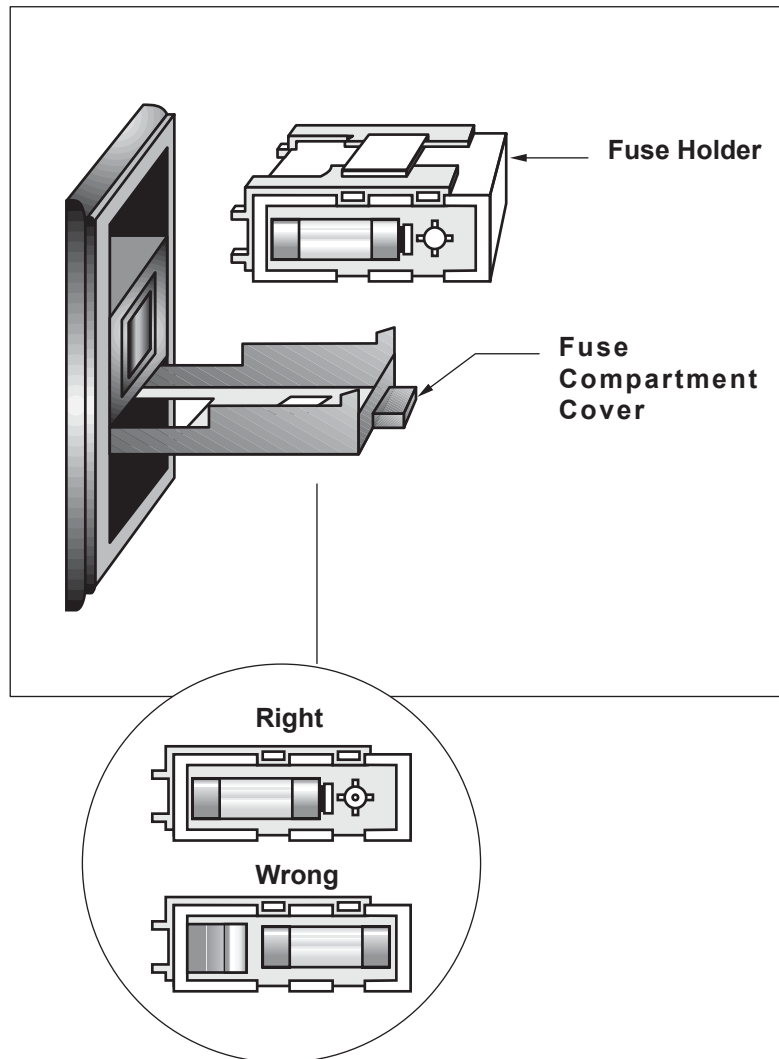

Figure 4.2 Changing the fuses

Specifications (Vacuum Membrane Degasser)

Capacity, solvent bottle holder:	Four 1-liter bottles
Number of solvent channels:	Four separate
Maximum flow rate per channel:	5 mL/min.
Volume/channel	12 mL
Solvent contact materials:	Teflon [®] (FEP and TFE) and Titanium
Maximum allowable tubing pressure:	5 psig (0.35 kg/cm ²)
Liquid connections (provided):	8 Teflon lines: approximately 31" long (inlet) approximately 20" long (outlet)
Electrical requirements:	110 VAC 60 Hz or 220 VAC 50 Hz
Fuse size:	T1A for all models (5 x 20 mm)
External dimensions (excluding bottles and tube clips)	H x W x D 14.5" x 6" x 21 5/8 36 cm x 15.2 cm x 55 cm
Weight (excluding bottles)	13.2 kg 29 lb.
Regulatory Compliance	FCC Class A CE (EN5011, EN 50082-1, EN61010-1)

Specifications (Solvent Helium Module)

Number of helium channels per manifold: Two, standard.

External dimensions (valve/switch manifold) H x W x D
9.6 cm x 3.8 cm x 2.5 cm

Spare Parts (Vacuum Degasser)

Part Number	Description
208300	Tee Connector (Tefzel) (Kit contains Tee connector for parallel flow connections; no tube nuts are included.)
208332	Tube Nut (without ferrule) for above Tee, Delrin
208306	Ferrule for above Tube Nut
3219-20042	Tubing
208330	Union, STD, Natural Poly
A0343-010	Bottle Cap Solvent Bottles
A3191-010	Solvent Bottle Cap Adapter
A4258-010	Solvent Filter 10 micron Teflon
1413-0430	Solvent Bottle, 1 liter
A0099-509	SCM1000 Vacuum Degasser Reference Manual (Manual contains installation, operation, troubleshooting, and maintenance instructions for the SCM1000 Vacuum Degasser.)

Spare Parts (Solvent Helium Module)

<u>Part Number</u>	<u>Description</u>
<i>Solvent Modules and Other Accessories</i>	
A4074-010	Solvent Inlet Tube Kit (Kit contains one bottle cap assembly, which includes an inlet filter, bottle cap, vent line, and one 5-foot tube with fitting and union.)
A4117-010	Solvent Tube Extension Kit (Kit contains four 5-foot tubes with fittings and unions.)
A4040-010	Solvent Conditioning Module (A four-solvent, vacuum- and helium-degassing module with bottles, tubes, and fittings.)
A4122-010	Two-solvent Helium Degassing Kit with Solvent Bottle Holder (Kit includes lines, spargers, manifold, connections, tubing, fittings, and the Bracket Kit.)
A4144-010	Four-solvent Helium Degassing Kit with Solvent Bottle Holder (Kit includes lines, spargers, manifolds, connections, tubing, fittings, and the Bracket Kit.)
A4125-010	Two-solvent Helium Degassing Kit (Kit includes manifold, connections, tubing, fittings, and the Bracket Kit.)
A0369-010	Sparger, 10-micron, for helium degassing
1413-0430	Wheaton Solvent Bottle, 1-liter
A4119-010	Solvent Bottle Holder
<i>Solvent Module Manual</i>	
A0099-506	Solvent Helium Module Reference Manual (Manual contains installation, operation, troubleshooting, and maintenance instructions for the SHM Solvent Helium Module.)

A

accessory kit contents
SHM, 6

B

back panel (degasser)
illustrated, 9
bottle tray
cleaning, 29
Bottles, solvent, 15
bracket, SHM
installation, 13

C

channels
rotating usage, 25
connections
degasser
typical in LC systems, 17
SHM, 15
conventions used in manual
hint, 1
icons, 1
note, 1
warning, 1

D

damage
reporting, 6
degassing
efficiency
effect of flow rate, 25
degasser
connection to eluants, 12
connection to pump
illustration, 23
diagrams showing typical connection of degassed
solvents, 18

priming, 21, 23
syringe illustration, 22
solvent connection to pump, 23
specifications, 32
degassing
importance of, 3

E

eluants, see solvents, 12

F

filter, installation of, 15
front panel
removal, 12
front panel (degasser)
illustrated, 8
slots, 23
fuses
changing, 30

H

helium manifold, see SHM, 15
High flow rates, plumbing for, 17
high voltage warning, 1
hints
defined, 1

I

Icons, 1
Installation
with SpectraSYSTEM, SpectraSERIES pumps, 13

M

maintenance
degasser, 29
manifold, helium degas see SHM, 15

N

notes
defined, 1

P

priming the degas tubing, 23

S

safety
high-voltage warning, 1
warning, 1

shipping kit contents
vacuum degasser, 6

SHM
about, 4
bracket
installation, 13
long rod, 13
short rod, 13
connection to eluants, 15
connection to helium, 15
package contents, 6
specifications, 33
valve/switch manifold
description, 15
illustration, 16

SHM installation
with SpectraSYSTEM, SpectraSERIES pumps, 13

solvents
changing, 29
connecting, 12

spargers, 15
specifications
degasser, 32
SHM, 33

T

top (degasser)
illustrated, 10

U

unpacking, 6
SHM, 6

V

vacuum degasser, 1
description, 3

vacuum degassing
benefits of, 3

valve/switch manifold, 15

W

warning
defined, 1