



Agilent Intuvo 9000 Gas Chromatograph

Operation Manual

Notices

© Agilent Technologies, Inc. 2022

No part of this manual may be reproduced in any form or by any means (including electronic storage and retrieval or translation into a foreign language) without prior agreement and written consent from Agilent Technologies, Inc. as governed by United States and international copyright laws.

Manual Part Number

G4580-90003

Edition

Eighth edition, October 2022
Seventh edition, September 2021
Sixth edition, July 2019
Fifth edition, March 2018
Fourth edition, September 2017
Third edition, April 2017
Second edition March 2017
First edition, September 2016

Printed in USA or China

Agilent Technologies, Inc.
2850 Centerville Road
Wilmington, DE 19808-1610 USA

Agilent Technologies, Inc.
412 Ying Lun Road
Waigaoqiao Freed Trade Zone
Shanghai 200131 P.R.China

Warranty

The material contained in this document is provided “as is,” and is subject to being changed, without notice, in future editions. Further, to the maximum extent permitted by applicable law, Agilent disclaims all warranties, either express or implied, with regard to this manual and any information contained herein, including but not limited to the implied warranties of merchantability and fitness for a particular purpose. Agilent shall not be liable for errors or for incidental or consequential damages in connection with the furnishing, use, or performance of this document or of any information contained herein. Should Agilent and the user have a separate written agreement with warranty terms covering the material in this document that conflict with these terms, the warranty terms in the separate agreement shall control.

Safety Notices

CAUTION

A **CAUTION** notice denotes a hazard. It calls attention to an operating procedure, practice, or the like that, if not correctly performed or adhered to, could result in damage to the product or loss of important data. Do not proceed beyond a **CAUTION** notice until the indicated conditions are fully understood and met.

WARNING

A **WARNING** notice denotes a hazard. It calls attention to an operating procedure, practice, or the like that, if not correctly performed or adhered to, could result in personal injury or death. Do not proceed beyond a **WARNING** notice until the indicated conditions are fully understood and met.

Contents

1 Introduction

Where to Find Information	10
Help & Information - from the Touch Screen	11
Help & Information - from the Web Browser	15
Help & Information - from your instrument data system	18
Before operating your GC	20
Chromatography Using a GC	21
GC Controls and External Connections	22

2 Operating Basics

Overview	26
Instrument Control	27
Using the Browser UI to Control the GC	27
Using the Intuvo Web Help	28
To Start Up the GC	30
To put the GC into Standby mode	31
To Shut Down the GC	32
Guard Chip Temperature Variation	33
Correcting Problems	34

3 Touch Screen Operation

Navigation	36
Status/Control Tray	38
Run Controls	39
Entering Data	40
Home View	42
Flow path page	43
Status page	44
Plot page	45
Methods View	47
Sequence View	48
Diagnostics View	49
Maintenance View	50
Logs View	51
Settings View	52

Touch Screen Functionality When the GC Is Controlled by an Agilent Data System	54
Data system changes to the touchscreen	54
Data system changes to the browser interface	55
GC Status	56
Status colors and details	56
Alert tones	57
Error conditions	58

4 Methods and Sequences

What Is a Method?	60
What Is Saved in a Method?	61
What Happens When You Load a Method?	62
View or Edit the Active Method	63
Viewing the Active Method	63
Editing a Method	64
GC Output Signals	65
Analog signals	66
Digital signals	69
Column compensation	72
Test plot	73
Loading a Method	75
Creating a New Method	76
Running Methods from the Touch Screen	77
To manually inject a sample with a syringe and start a run	77
To run a method to process a single sample using an ALS	77
To abort a method	78
What Is a Sequence?	79
Recoverable Errors	80

5 Diagnostics

About Diagnostics	82
System health report	82
Automated Testing	83
Using the Diagnostics View	84
Performing Diagnostic Tests	86

6 Early Maintenance Feedback

Early Maintenance Feedback (EMF)	90
Counter types	90
Thresholds	90
Default Thresholds	91
Available Counters	92
Viewing Maintenance Counters	95
To Enable, Reset, or Change a Limit for an EMF Counter	96
EMF Counters for Columns	98
EMF Counters for Autosamplers	99
Counters for 7693A and 7650 ALS with EMF-enabled firmware	99
Counters for ALS with earlier firmware	99
EMF Counters for MS Instruments	100

7 Logs

Logs View	102
-----------	-----

8 Settings

About Settings	106
Service Mode	107
Resetting system items	109
About This GC	111
Calibration	112
Maintaining EPC calibration—inlets, detectors, PCM, and AUX	113
To zero a specific flow or pressure sensor	114
System Settings	115
Configuring the IP address for the GC	115
To set system date and time	117
To change the system locale	118
To set system power saving features	119
To access stored run data	120
To control Browser Interface access	121
To change the remote advisor settings	122
To run the system setup routine	125
Tools (Browser Interface)	126
Performing a Column Compensation Run	127
Power Options	128

9 Configuration

About Configuration	130
Making Configuration Changes	131
Valve Configuration	133
To configure valves	133
Inlet Configuration	135
To configure the Inlet Gas type	135
Shutdown behavior	137
Detector 1/Detector 2 Configuration	138
To configure the makeup/reference gas	138
MSD and Headspace Configuration	140
MSD Configuration	140
Headspace Sampler Configuration (7697)	141
Headspace Sampler Configuration (8697)	142
Miscellaneous Settings	143

10 Resource Conservation

Resource Conservation	146
Sleep Methods	147
Wake and Condition Methods	149
To Set the GC to Conserve Resources	150

11 Programming

Clock Time Programming	154
Using clock time events	154
Adding events to the clock table	154
Deleting clock time events	155

12 Chromatographic Checkout

About Chromatographic Checkout	158
To Prepare for Chromatographic Checkout	159
To Check FID Performance	160
To Check TCD Performance	164
To Check NPD Performance	168
To Check ECD Performance	172
To Check FPD ⁺ Performance (Sample 5188-5953)	177
Preparation	177
Phosphorus performance	178
Sulfur performance	181

To Check FPD ⁺ Performance (Sample 5188-5245, Japan)	183
Preparation	183
Phosphorus performance	184
Sulfur performance	188

13 Intelligent Instrument Features

System-Level Communications	192
GC/MS Systems	193
Venting the MS	193
MS Shutdown events	193
GC Pressure Shutdown events	194

14 Operating Splitter and Backflush Accessories

G7322A Mid-Column Backflush to D1 with EPC Accessory	196
Introduction	196
Operation	197
G7323A Mid-Column Backflush to D2/MS with EPC Accessory	199
Introduction	199
Operation	200
G7324A Post-Column Backflush to D1 with EPC Accessory	202
Introduction	202
Operation	204
G7325A Post-Column Backflush to D2/MS with EPC Accessory	206
Introduction	206
Operation	208
G7326A Inlet Splitter to Two Columns Accessory	210
Introduction	210
Operation	211
G7329A 1:1 D1-MS Detector Splitter Accessory	213
Principles of Operation	213
G3950A #886 1:1 D1-D2 Detector Splitter Accessory	217
Introduction	217
Operation	218

15 Chinese Metrology Testing

FPD ⁺ and ECD Unit Conversion Factors	220
Conversion factors for the FPD ⁺	220
Conversion factor for the ECD	221
Using the Conversion Factors	222
References	223



1 Introduction

Where to Find Information	10
Help & Information - from the Touch Screen	11
Help & Information - from the Web Browser	15
Help & Information - from your instrument data system	18
Before operating your GC	20
Chromatography Using a GC	21
GC Controls and External Connections	22

This document provides an overview of the Agilent Intuvo 9000 Gas Chromatograph (GC) along with detailed operating instructions.



Where to Find Information

Agilent provides all the documentation for installing, operating, and maintaining the GC directly on the Intuvo 9000 GC.

When unpacking the instrument, make sure you take a look at the provided Intuvo 9000 GC Quick Start Poster.

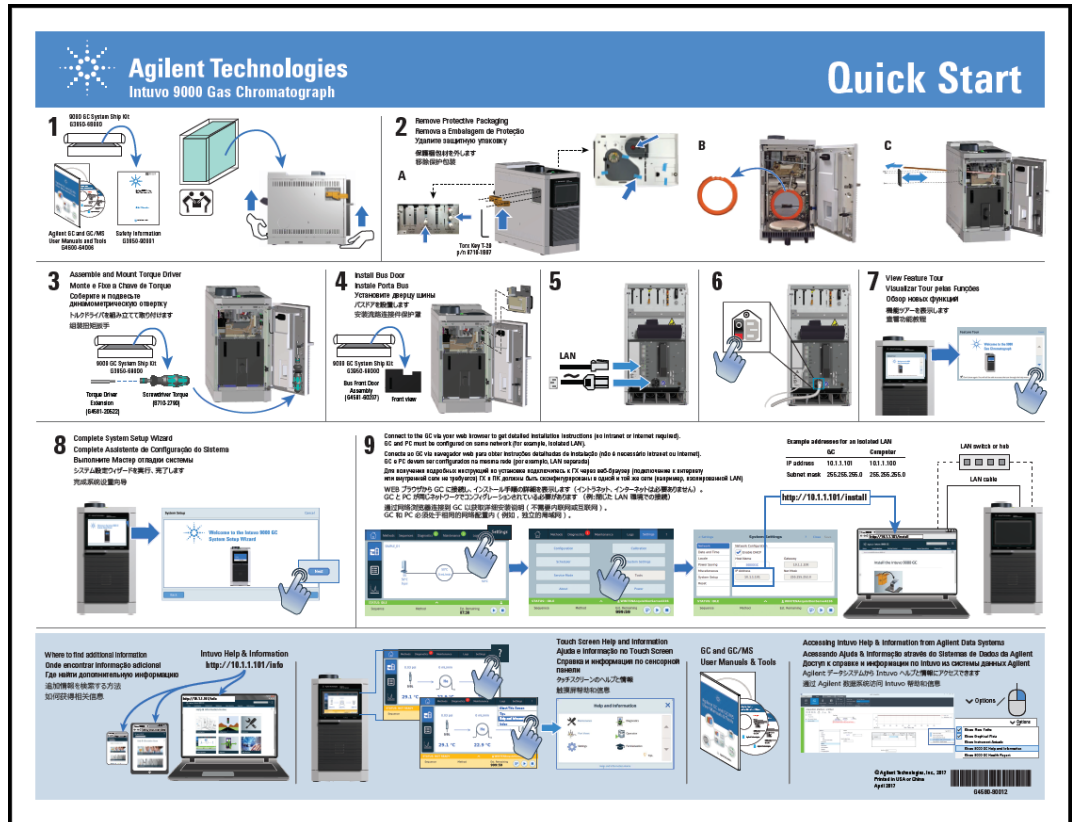

You can get to Intuvo 9000 GC Help and Information by multiple means. Most of the questions that you might have about the Intuvo 9000 GC can be resolved by checking out this comprehensive set of information.

- **“Help & Information - from the Touch Screen”.** Context-sensitive information is available right from the Intuvo GC touch screen.
- **“Help & Information - from the Web Browser”.** The complete set of user information is also available directly from the GC by using a connected web browser.

- [“Help & Information - from your instrument data system”](#). The complete set of user information is also available from your instrument data system.
- The Agilent web site. The latest manuals are available for download from the Agilent web site.

Help & Information - from the Touch Screen

Available right at your fingertips from the Intuvo 9000 GC is an extensive amount of on-board documentation designed to assist with topics such as getting started, familiarization, installation, operation, maintenance, troubleshooting and other useful information.

There are several ways to access this information, including through the touch screen help '?' menu. Here you will find not only context-sensitive information, but also a listing of tips to quickly guide you to information needed and a full Help and Information suite with topics about maintenance, diagnostics, part views, operations, settings and familiarization.

See [“Touch Screen Help”](#) on page 12 for additional information and features available with the touch screen help package.

1 Introduction

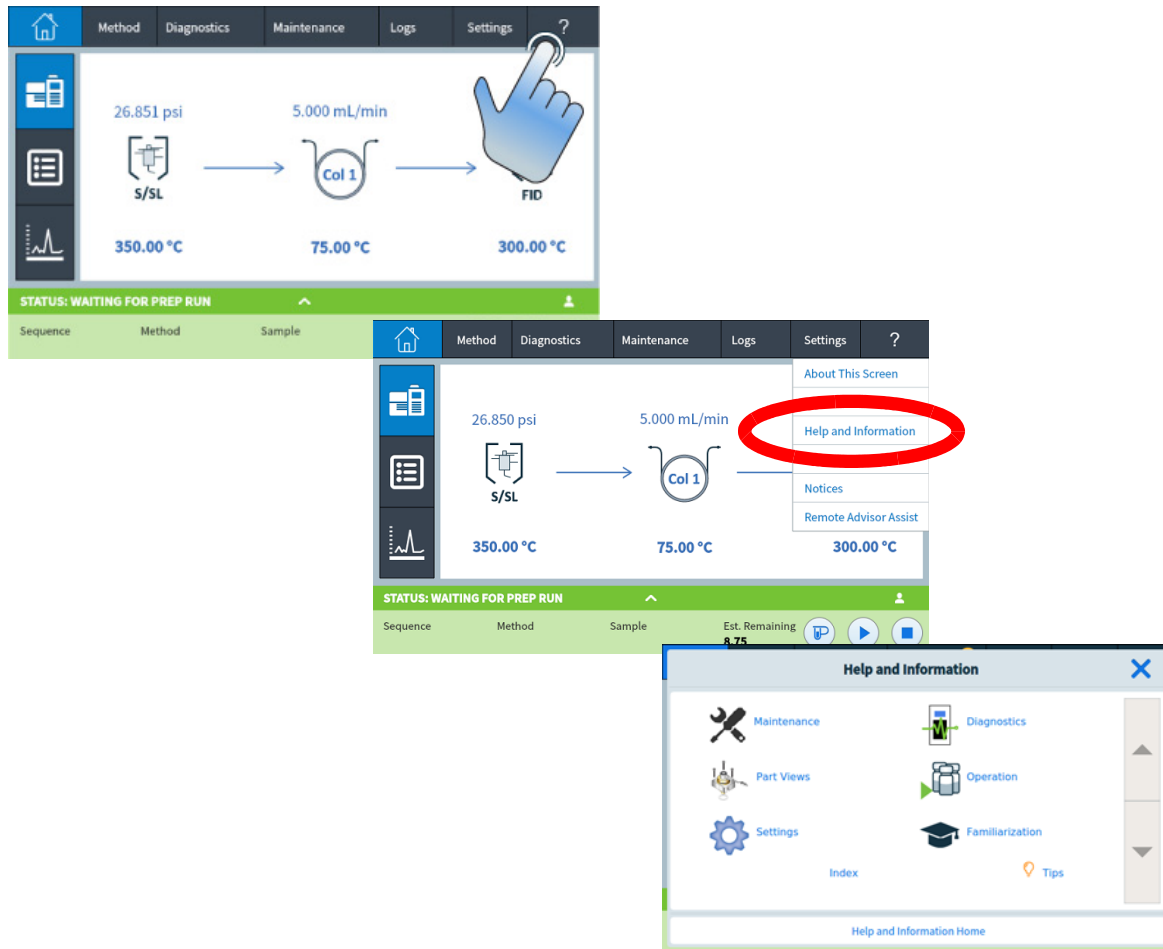

Touch Screen Help

When using the GC, a help menu is available by pressing the question mark (?) in the upper right corner of the touch screen. The help menu provides access to Context-sensitive help about the screen you are viewing, Tips, access to the full Help & Information suite, as well as an Index to assist in finding needed information.

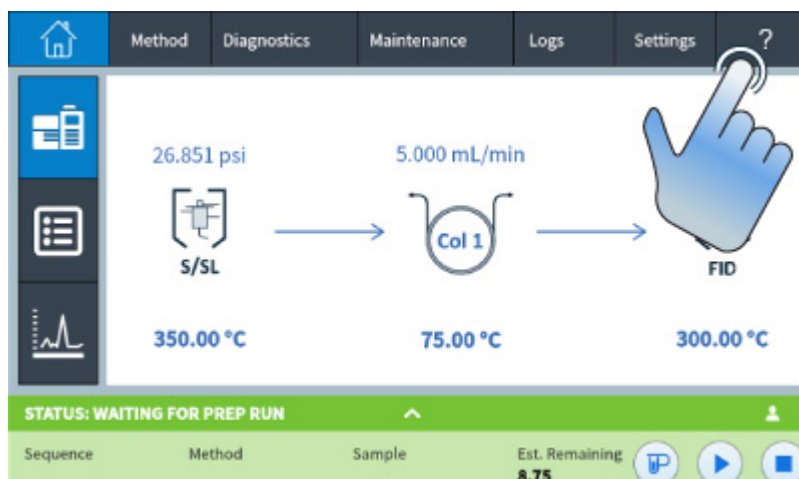

- 1 Context-sensitive help provides specific details about the screen currently being viewed.

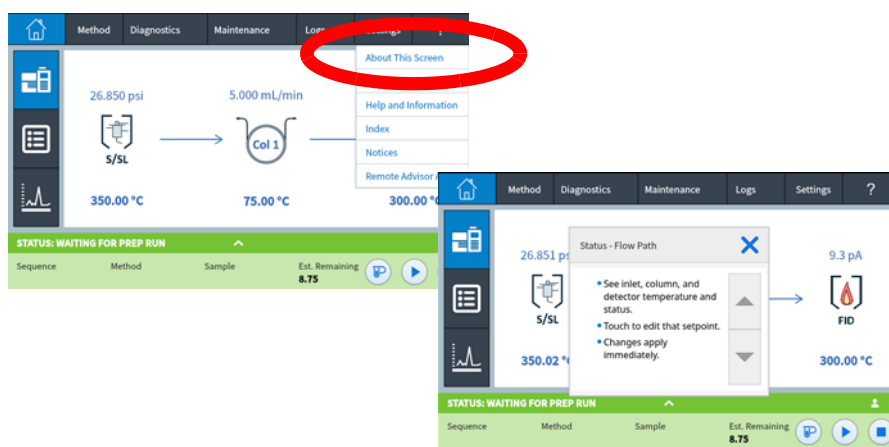

- 2 Tips provides helpful information on how to use the GC. Individual tips are provided which contain answers to frequently asked questions as well as links to frequently used procedures.

1 Introduction

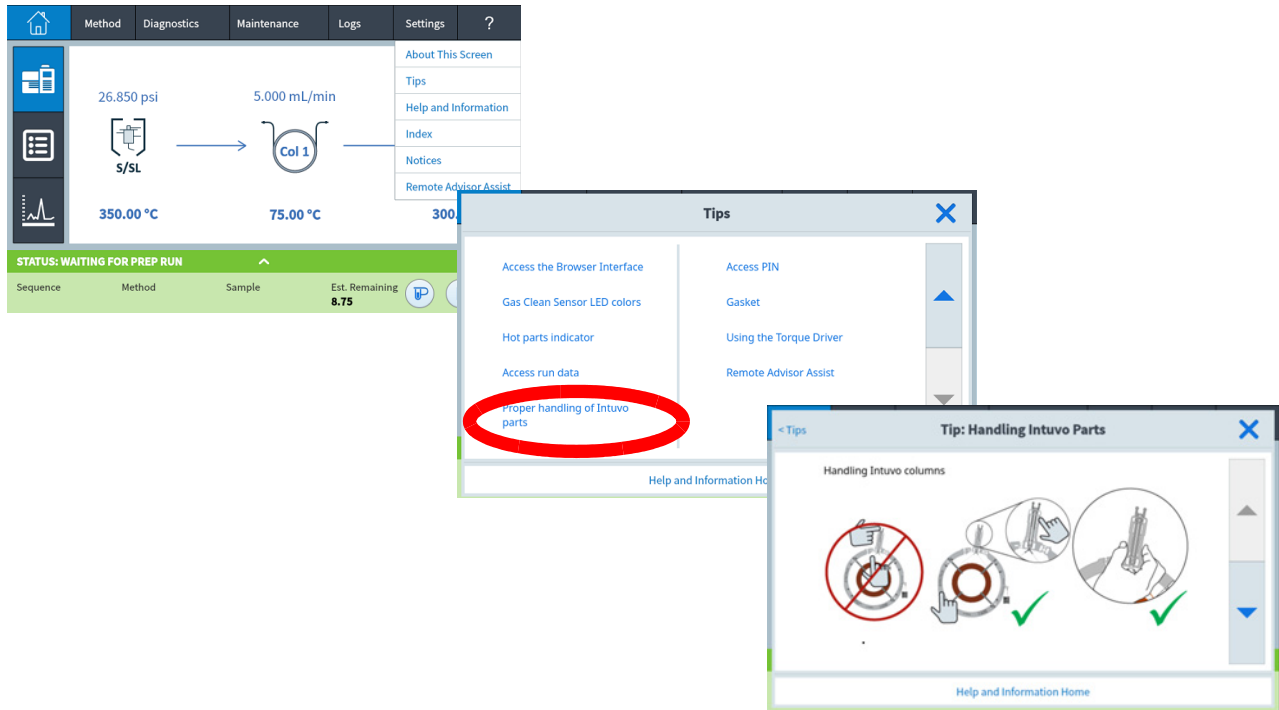

- 3 Help & Information provides comprehensive, in-depth information related to maintenance, diagnostics, part views, operation, settings, and more.

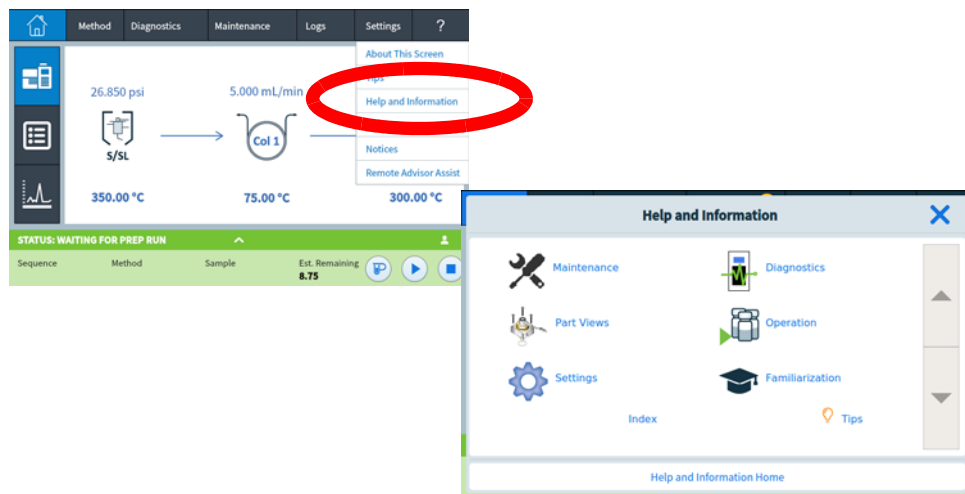

- Maintenance: How to take care of the inlets, detectors, and modules available on this configured GC.
- Part Views: The consumable parts for inlets, detectors, and modules configured on this GC.

- Settings: Configuration and calibration for each available module on this GC. Also includes explanation for the Instrument Scheduler.
 - Diagnostics: Automated and manual tests available on this GC.
 - Operation: How to use the inlets, detectors, and modules available on this configured GC.
 - Familiarization:
 - Where to find information regarding the GC.
 - Using the touch display.
 - How to use the system setup wizard.
 - Accessing the Feature Tour.
 - Overview of the GC parts.
- 4 The Index provides an alphabetized list of the topics contained in the touch screen help.

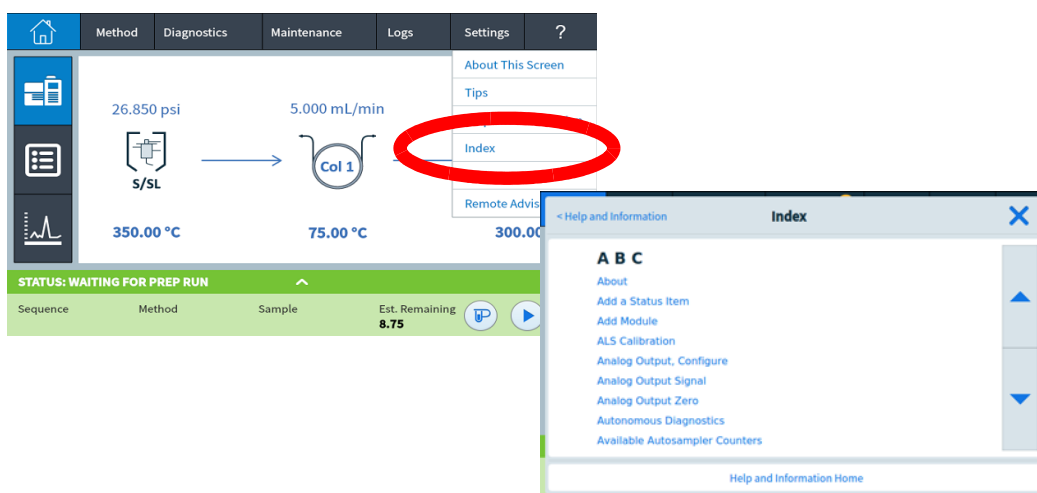

Help & Information - from the Web Browser

A more enhanced version of Help & Information can also be easily accessed from the Intuvo GC by typing the Instrument “IP Address Number” or “Host Name” into a browser on a PC or tablet that is on the same network as the GC. No Internet is required to use this enhanced help package.

Example: <http://xxx.xx.xxx/info> where 'xxx.xx.xxx' is the IP Address or Host Name of the GC).

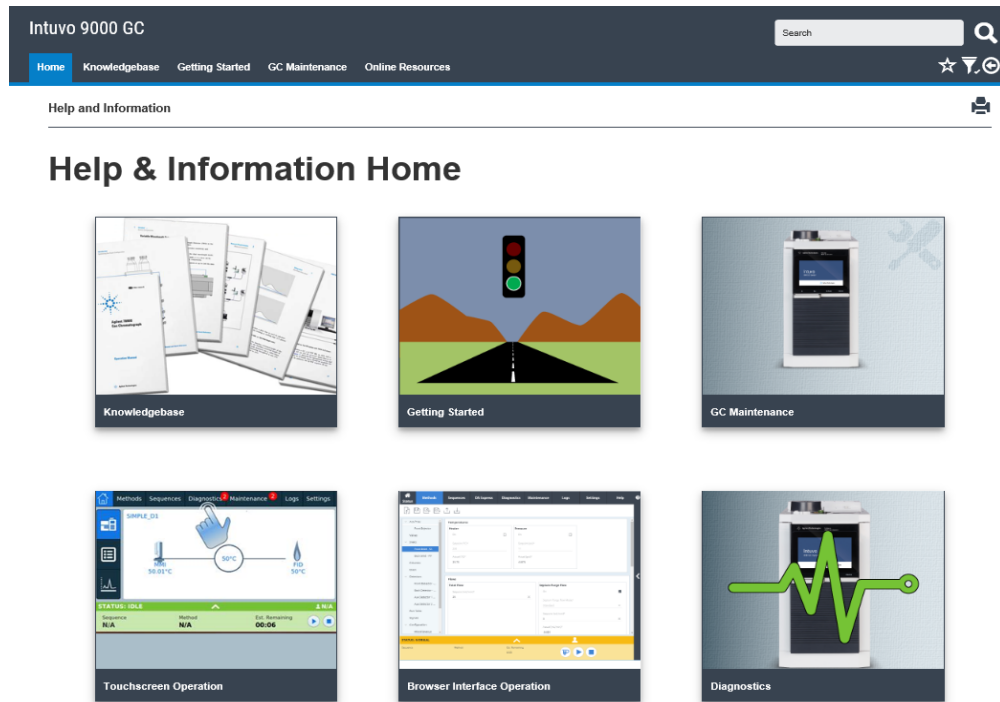

You can also access a list of the links for chip replacement procedures by typing the Instrument “IP Address Number” or “Host Name” followed by “/chips” into a browser on a PC or tablet that is on the same network as the GC. No internet connection is required to use this enhanced help package.

Example: <http://xxx.xx.xxx/chips> where 'xxx.xx.xxx' is the IP Address or Host Name of the GC.

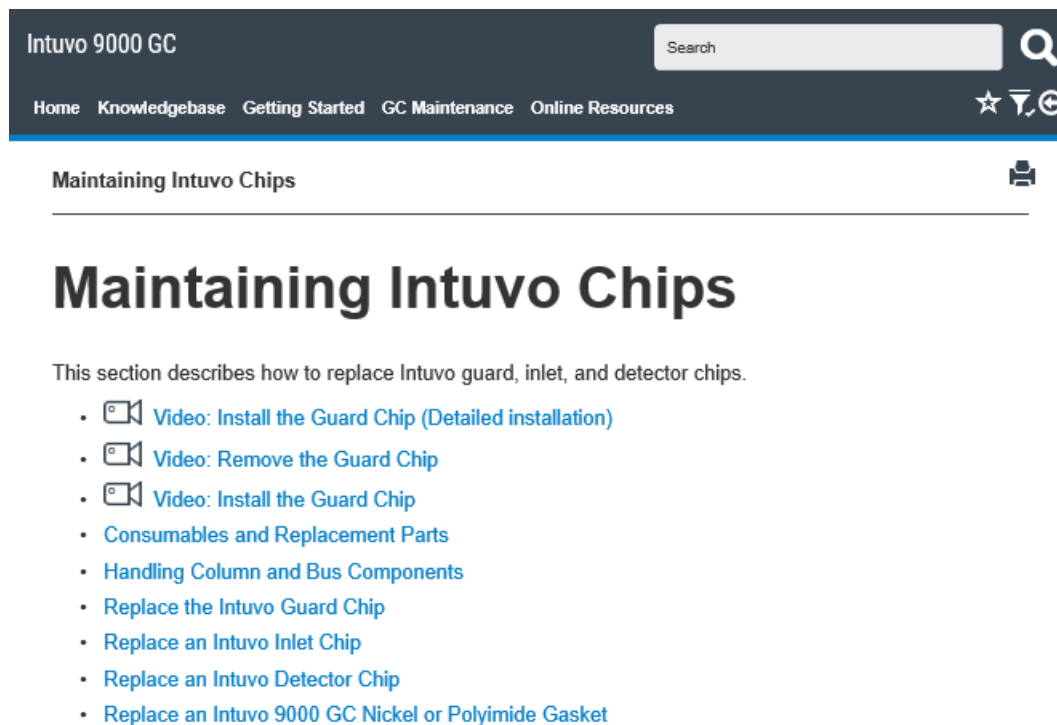

Intuvo 9000 GC



Search

Home Knowledgebase Getting Started GC Maintenance Online Resources

Maintaining Intuvo Chips

Maintaining Intuvo Chips

This section describes how to replace Intuvo guard, inlet, and detector chips.

-  [Video: Install the Guard Chip \(Detailed installation\)](#)
-  [Video: Remove the Guard Chip](#)
-  [Video: Install the Guard Chip](#)
- [Consumables and Replacement Parts](#)
- [Handling Column and Bus Components](#)
- [Replace the Intuvo Guard Chip](#)
- [Replace an Intuvo Inlet Chip](#)
- [Replace an Intuvo Detector Chip](#)
- [Replace an Intuvo 9000 GC Nickel or Polyimide Gasket](#)

You can also access information on column installation by typing the Instrument “IP Address Number” or “Host Name” followed by “/column” into a browser on a PC or tablet that is on the same network as the GC. No internet connection is required to use this enhanced help package.

Example: <http://xxx.xx.xxx/column> where 'xxx.xx.xxx' is the IP Address or Host Name of the GC.

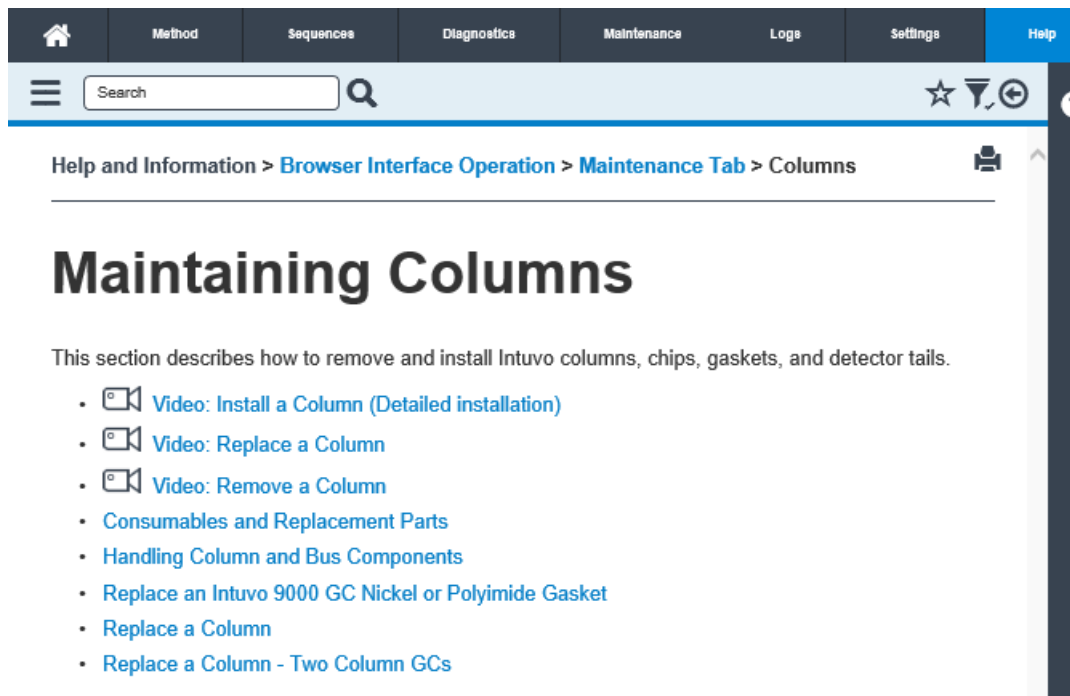

Help & Information - from your instrument data system

Help & Information can also be accessed from the options pull-down of most data systems instrument pages.

Flow Path

- SS Inlet: 30.3 psi (250 °C), 37.8 °C (250 °C)
- Column #1: 75 °C (75 °C), 6.5 mL/min
- Detector 1 TCD: 30.8 °C (250 °C), 3.1928 mL/min
- Detector 2 ECD: 36.1 °C (250 °C), 3.3072 mL/min
- Guard Chip: 100 °C (100 °C)

** One or more heated zones are off. This can result in large differences between actuals and setpoints for flow and pressure.*

Graph

Y-axis: psi (left), mL/min (right)

X-axis: Run Time, min

Legend:

- Oven: °C#
- Column #1 He: psi
- Column #1 He: mL/min

Options

- Show Flow Paths
- Show Graphical Plots
- Show Instrument Actuals
- Show 9000 GC Help and Information
- Show 9000 GC Health Report

Intuvo 9000 GC Links

- [Help & Information](#)
- [Browser Interface](#)

Selection

- SS Inlet He -->
- Locked
- Agilent 190915-413UI: N409034H
- HP-5MS UI
- 60 °C—325 °C (350 °C); 30 m x 320 µm x 0.25 µm
- > Detector 1 TCD

Columns

Control Mode: On

Parameter	Actual	Setpoint
Flow	6.5 mL/min	6.5 mL/min
Pressure	30.152 psi	32.271 psi
Average Velocity		67.014 cm/sec
Holdup Time		0.74611 min

Constant Flow: [Dropdown]

Post Run: 1 mL/min

(Initial): 0 min
He @ 75 °C Oven
Out: Ambient Pressure
30 m x 320 µm x 0.25 µm

Before operating your GC

Before operating your GC, be sure to read the safety and regulatory information provided through the GC browser interface (or downloaded from the Agilent web site). The most common safety hazards when working on the GC are:

- Burns caused by touching heated areas on or in the GC
- Release of pressurized gas containing hazardous chemical compounds caused by opening inlets
- Glass cuts or puncture wounds caused by sharp capillary column ends
- Use of hydrogen as a GC carrier gas

Chromatography Using a GC

Chromatography is the separation of a mixture of compounds into individual components.

There are three major steps involved with separating and identifying components of a mixture using a GC. They are:

- 1 Injecting a sample into the GC. (This takes place at the inlet.)
- 2 Separating the sample into individual components. (This takes place inside the column.)
- 3 Detecting what compounds are in the sample. (This is done in the detector.)

During this process, status messages from the GC are displayed on, and user changes to parameter settings can be made through, the touch screen on the GC or a connected data system.

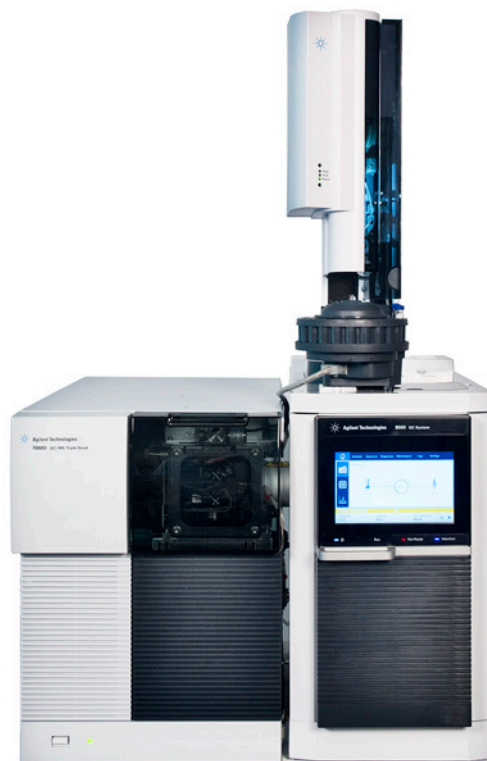

GC Controls and External Connections

The figures below show the front and rear of the GC, including all controls and connectors. See [Figure 1](#) and [Figure 2](#).

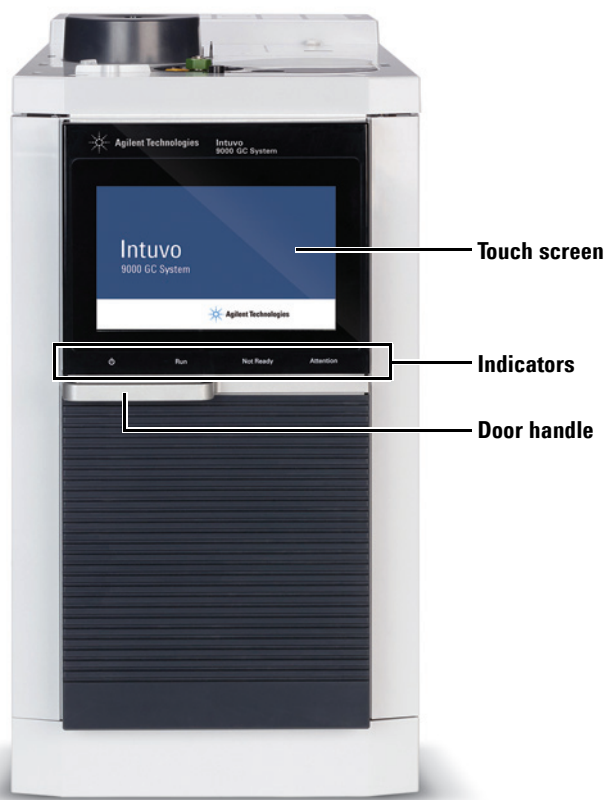

Figure 1 Agilent Intuvo 9000 GC Front Panel

The front of the GC includes a door which provides access to the GC bus and columns. The door houses the GC touch screen and indicators.

Touch screen: The touch screen shows GC status and activity information, and provides access to GC setpoints, real-time signals, diagnostics, maintenance information, logs, and instrument configuration settings. To save energy and increase display life, the touch screen darkens after an operator specified period of inactivity. Touching the screen brightens it again.

Indicators: The GC includes several indicators to provide quick status information without accessing the display:

- **⏻** (power) - The power indicator is lit when the GC is connected to power and switched on via the rear panel power switch.
- **Run** - The Run indicator is lit when a run is in process.
- **Not Ready** - The Not Ready indicator is lit when a component of the GC is not ready to begin a run.
- **Attention** - The Attention indicator is lit when there is a problem with the GC that requires operator intervention.

The GC back panel includes the gas connections, exhaust vents communication connections, injector and tray control connections, power on/off switch, power cord connector, and air intake.

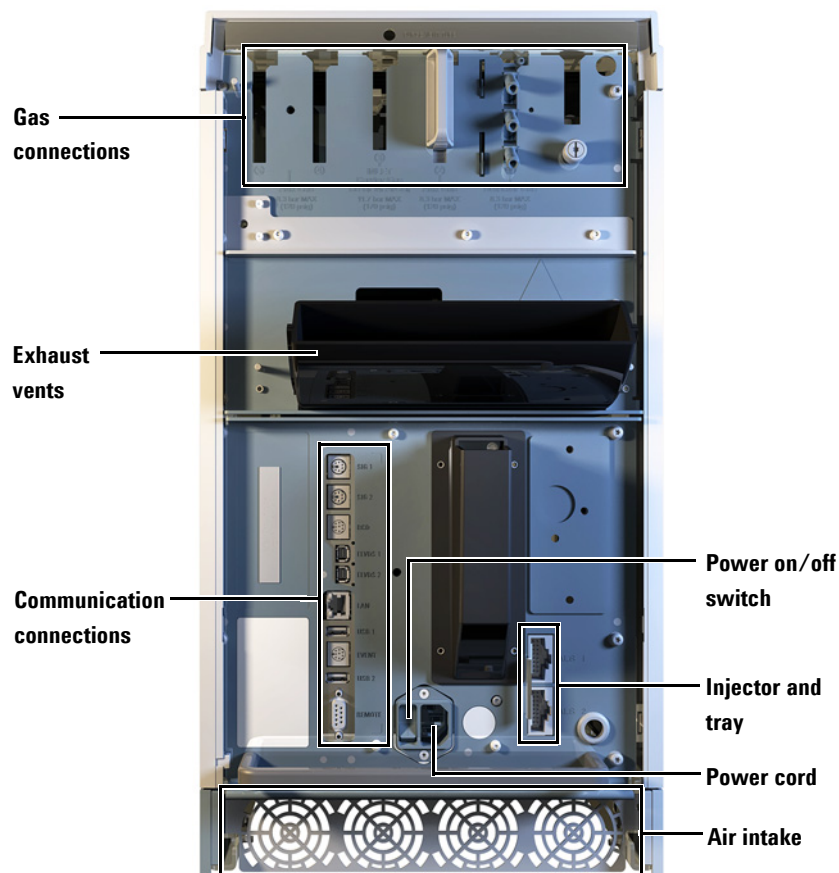

Figure 2 GC back panel

1 Introduction



2 Operating Basics

Overview	26
Instrument Control	27
Using the Browser UI to Control the GC	27
Using the Intuvo Web Help	28
To Start Up the GC	30
To put the GC into Standby mode	31
Guard Chip Temperature Variation	33
Correcting Problems	34

This section describes a few basic tasks that an operator performs when using the Agilent Intuvo 9000 GC.



Overview

Operating the GC involves the following tasks:

- Setting up the GC hardware for an analytical method.
- Starting up the GC. See [“To Start Up the GC”](#) on page 30.
- Preparing the automatic liquid sampler, if used. This includes installing the method-defined syringe; configuring solvent and waste bottle usage and syringe size; and preparing and loading solvent, waste, and sample vials.

Refer to the Installation, Operation, and Maintenance manual for the supported ALS:

- 7650 GC ALS
- 7693 GC ALS
- Loading the analytical method or sequence. The GC stores a single method and does not store sequence information. The existing method on the GC (referred to as the Active Method) can be edited as desired. Loading other methods, or using sequences, requires a connection to an Agilent data system.
 - Refer to the Agilent data system documentation for details on loading analytical methods or using sequences from the connected data system.
 - For standalone GC operation see [“Loading a Method”](#) on page 75.
- Running the method or sequence.
 - Refer to the Agilent data system documentation for details on running analytical methods or sequences from the connected data system.
- Monitoring sample runs from the GC touch screen, connected browser UI, or a connected data system.
- Shutting down the GC. See [“To put the GC into Standby mode”](#) on page 31 or [“To Shut Down the GC”](#) on page 32.

Instrument Control

The Agilent Intuvo 9000 GC can be operated via a data system, a computer or mobile device running the browser UI, or can be operated standalone.

- The GC is typically controlled by an attached data system such as Agilent OpenLab CDS.

Using sequences requires a connection to an Agilent data system.

Refer to the online help included in the Agilent data system for details on how to load, run, or create methods and sequences using the data system.

- The GC touch screen provides feedback on the status of the instrument and allows editing of the Active Method and of the current GC configuration.
- The browser UI is also available.

Using the Browser UI to Control the GC

You can use a browser UI to perform many functions of the GC touch screen via a network connection between your computer/tablet/portable device and the GC.

If more than one browser connects to a single GC, the first connected browser will have complete control. Other browser connections will only be able to monitor GC status and perform a limited set of tasks.

If a data system is connected to the GC, the data system will have complete control of that GC. All browser interface connections will only be able to monitor status and perform a limited set of tasks.

NOTE

It is recommended that you disable any popup-blockers associated with your web browser when controlling the GC via the browser UI. Failure to do so may make some functionality unavailable.

To use the browser UI, do the following:

- 1 Connect your device to the GC either directly or via the internal lab or office network. (An internet connection is not required.)
- 2 Launch your internet browser on your device.

- 3 Enter the IP address of the GC in the address bar of the browser. For example: `http://10.1.1.100`
- 4 Press Enter. The browser UI launches in the browser. See [Figure 3](#).

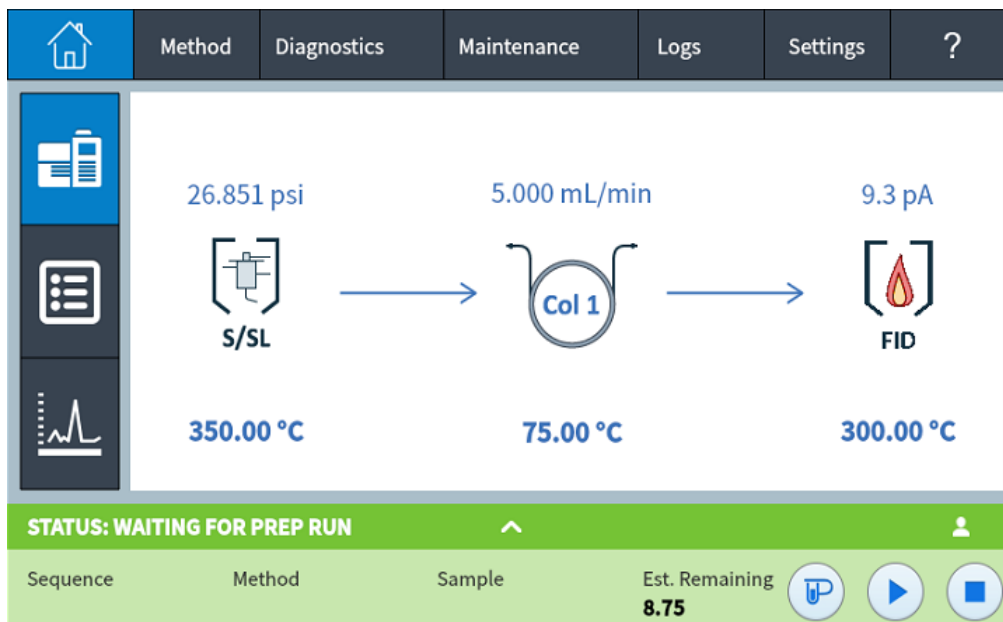

Figure 3 Browser UI home page

Using the Intuvo Web Help

You can use a web browser to access the functions of the GC online help via a network connection between your computer/tablet/portable device and the GC.

To use the Intuvo Web Help, do the following:

- 1 Connect your device to the GC either directly or via the internal lab or office network. (An internet connection is not required.)
- 2 Launch your internet browser on your device.
- 3 Enter the IP address of the GC in the address bar of the browser. For example: `http://10.1.1.100/info`
- 4 Press Enter. The Intuvo Web Help launches in the browser. See [Figure 4](#).

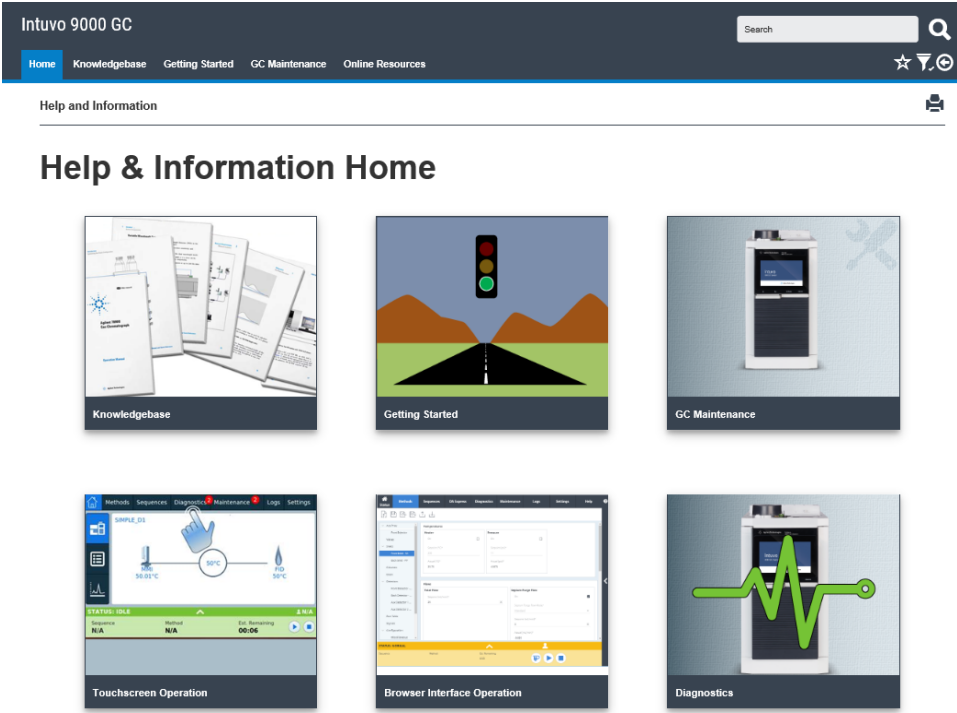

Figure 4 Intuvo Web Help - Help & Information Home

To Start Up the GC

Successful operation begins with a properly installed and maintained GC. The utility requirements for gases, power supply, venting of hazardous chemicals, and required operational clearances around the GC are detailed in the *Intuvo Site Preparation Guide*.

- 1 Check gas source pressures. For required pressures, refer to the *Intuvo Site Preparation Guide*.
- 2 Turn on the carrier and detector gases at their sources, and open the local shutoff valves.
- 3 With the GC connected to a power outlet, switch on the GC using the rear panel power on/off switch.
- 4 Wait for the Status view to appear on the touch screen.
- 5 Install the column and trap. Refer to the *Agilent Intuvo 9000 Gas Chromatograph Maintaining Your GC* guide for details.
- 6 Check that the column fittings are leak free. Refer to the *Agilent Intuvo 9000 Gas Chromatograph Troubleshooting* guide for details.
- 7 Select the analytical method to be used:
 - If connected to an Agilent data system, load the analytical method using the data system.
 - For standalone GC operation, edit the Active Method as required. See “[Methods and Sequences](#)” on page 59.
- 8 Wait for the detector(s) to stabilize before acquiring data. The time required for the detector to reach a stable condition depends on whether the detector was turned off or its temperature was reduced while the detector remained powered. See [Table 1](#).

Table 1 Detector stabilization times

Detector type	Stabilization time starting from a reduced temperature (hours)	Stabilization time starting from detector off (hours)
FID	2	4
TCD	2	4
ECD	4	18 to 24
FPD+	2	12
NPD	4	18 to 24

To put the GC into Standby mode

- 1 Wait for the current run to finish.
- 2 If you are connected to an Agilent data system, and the Active Method has been modified, save the changes in the data system.

WARNING

Never leave flammable gas flows on if the GC will be unmonitored. If a leak develops, the gas could create a fire hazard.

- 3 Turn off all gases, except a nonflammable carrier gas, at their sources. (Leave the nonflammable carrier gas on to protect the column from atmospheric contamination.)
- 4 If you are using cryogenic cooling, turn off the cryo coolant at the source.
- 5 Reduce detector, inlet, and column temperatures to between 150 and 200 °C. If desired, the detector can be turned off. See [Table 1](#) on page 30 to determine if it is advantageous to shut down the detector for a short time period. The time required to return the detector to a stable condition is a factor to consider.

To Shut Down the GC

Refer to the *Agilent Intuvo 9000 Gas Chromatograph Maintaining Your GC* guide for procedures for installing columns, consumables, and so on.

- 1 If the GC is connected to an Agilent data system, and a maintenance method is available, load the GC maintenance method and wait for the GC to become ready. Refer to the online help included in the Agilent data system for details on how to load a method using the data system.
- 2 Cool all heated zones to 40 °C and set safe gas flows. Put the GC in general maintenance mode. At the GC touch screen go to **Maintenance > Instrument > Perform Maintenance > Maintenance Mode > Start Maintenance** and wait for the GC to become ready.
- 3 Turn off the power on/off switch on the rear panel of the GC.
- 4 Shut off all gas valves at the gas source.
- 5 If you are using cryogenic cooling, shut off the cryo coolant valve at the source.

WARNING

Be careful! The column compartment, column flow path, inlet, and/or detector may be hot enough to cause burns. If they are hot, wear heat-resistant gloves to protect your hands.

- 6 When the GC is cool, remove the column and cap both ends to keep out contaminants.
- 7 Cap all external GC fittings.

Guard Chip Temperature Variation

When idle, the GC dynamically varies the temperature of the Guard Chip in order to extend its life. When you perform a run, the GC will restore the Guard Chip temperature to the setting specified in the active method.

Correcting Problems

If the GC stops operation because of a fault, check the touch screen for any messages. The GC includes diagnostics functions to help you determine the cause of a fault.

- 1 Use the touch screen, browser UI, or data system to view the alert. (See “[Home View](#)” on page 42 for details.)
- 2 Press the stop button  on the touch screen or browser UI, or turn off the offending component in the data system.
- 3 Diagnose the problem using the built in diagnostics tools on the GC. See “[Diagnostics](#)” on page 81.
- 4 Resolve the problem, for example, by changing gas cylinders or fixing the leak. Refer to the *Agilent Intuvo 9000 Gas Chromatograph Troubleshooting* guide for details.
- 5 Once the problem is fixed, you may need to either power cycle the instrument, or use the touch screen, browser UI, or data system to turn the problem component off, then on again. For shutdown errors, you will need to do both.



3 Touch Screen Operation

Navigation	36
Status/Control Tray	38
Run Controls	39
Entering Data	40
Home View	42
Flow path page	43
Status page	44
Plot page	45
Methods View	47
Sequence View	48
Diagnostics View	49
Maintenance View	50
Logs View	51
Settings View	52
Touch Screen Functionality When the GC Is Controlled by an Agilent Data System	54
GC Status	56
Status colors and details	56
Alert tones	57
Error conditions	58

This section describes the basic operation of the Agilent Intuvo 9000 GC touch screen.



Navigation

The touch screen provides access to all GC settings, controls, and information. Touch a control to access more information, to enable a setting or control, or to enter data using a touch keyboard or keypad interface, as applicable. See [Figure 5](#).

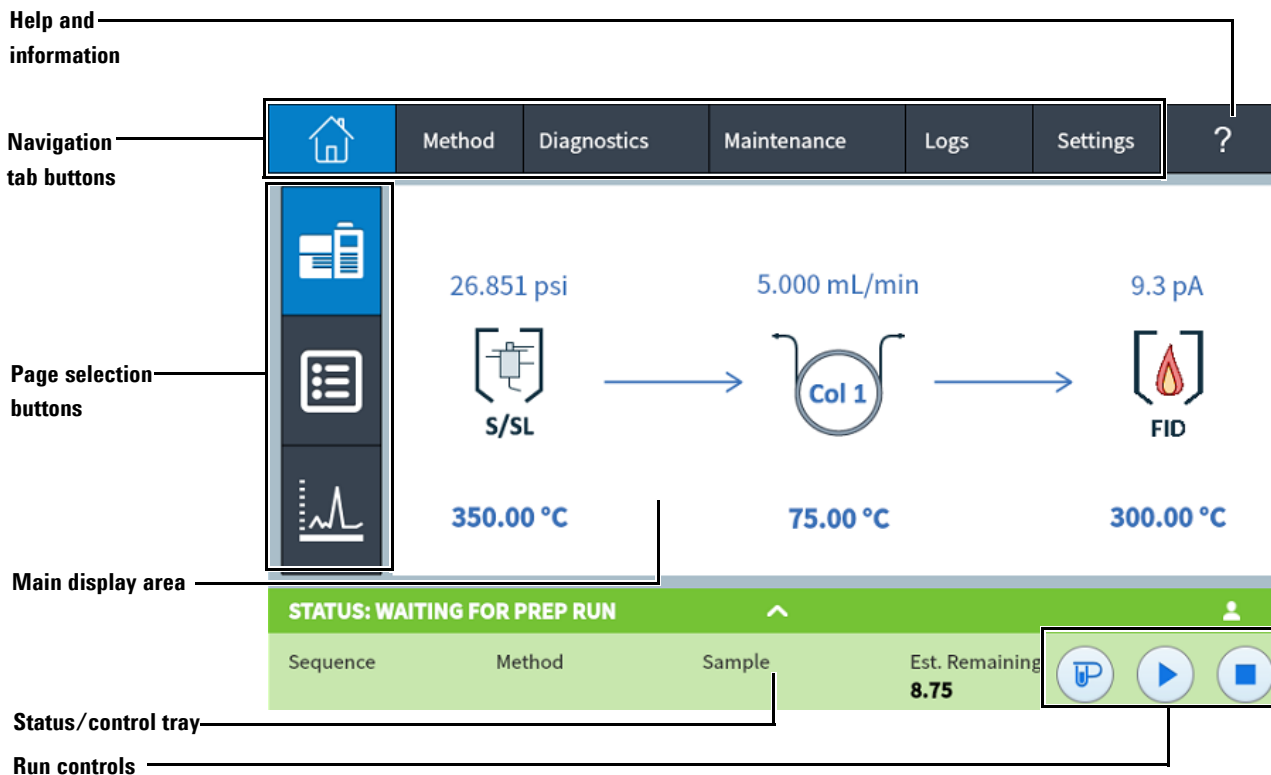

Figure 5 Touch screen home page

The navigation tab buttons across the top of the touch screen provide access to different functional areas. Pressing a button brings up the corresponding tab.

The currently selected page or tab is highlighted.

Pressing the ? (help and information) button provides access to online help and documentation for the GC.

On the home page, pressing one of the page selection buttons loads the corresponding page.

The main display area provides information related to the selected functional area/page. This area contains status displays, controls, settable parameters, and so on.

Depending on which page is selected, additional controls may appear. This can include page selection buttons, selectable tabs, back and next buttons, scroll buttons, and so on. See Figure 6.

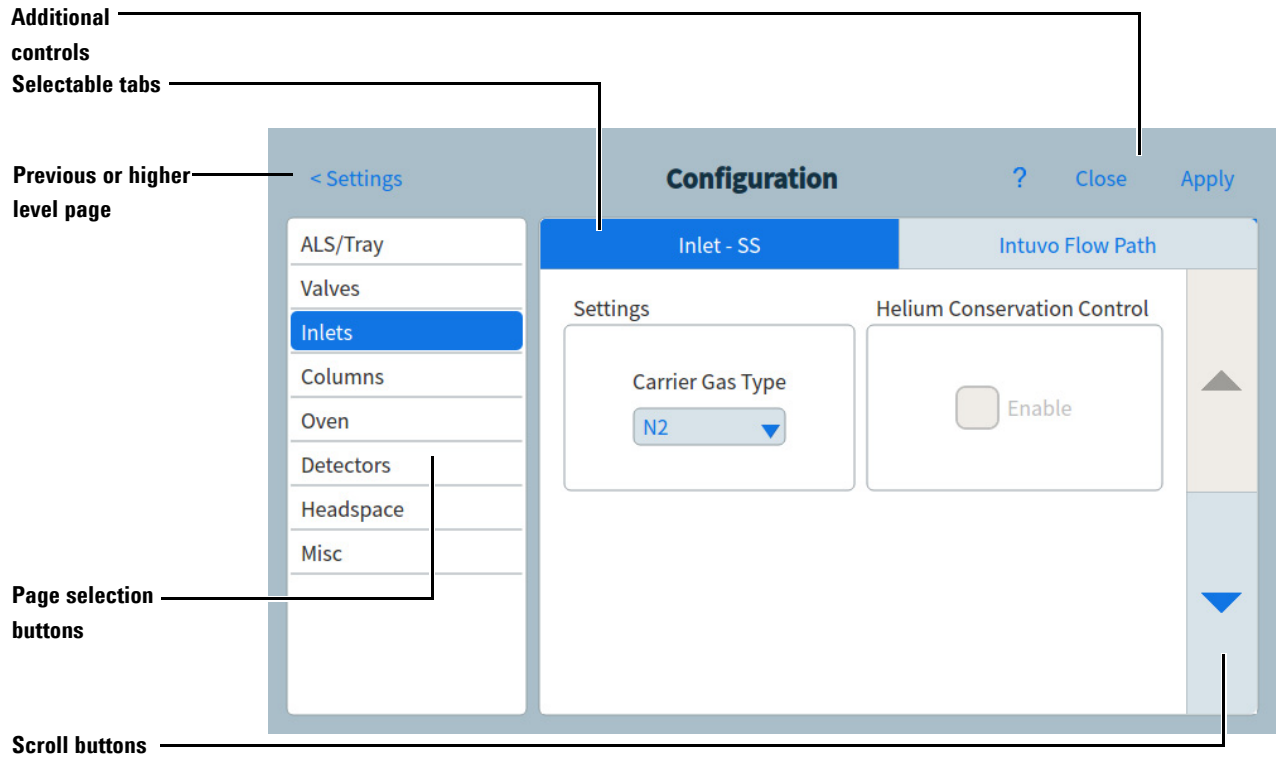

Figure 6 Additional controls

Scroll buttons are enabled if additional information or settings are available via scrolling.

Status/Control Tray

The status/control tray provides details on the current status of the GC, the current sequence and method (if connected to an Agilent data system), the time remaining for the current operation being performed by the GC, run controls, and so on.

The status/control tray is color coded to reflect the run or ready status of the GC:

- Green - OK
- Yellow - Not Ready
- Blue - Run in Progress
- Purple – Preparing Sample
- Teal – Sleep mode
- Red – Error
- Dark orange – Maintenance Mode (a maintenance task is running)

Any EMF (Early Maintenance Feedback) flags are also displayed. See “[Early Maintenance Feedback](#)” on page 89.

The tray can be expanded by pressing the arrow on the tray. See [Figure 7](#).

Help and information

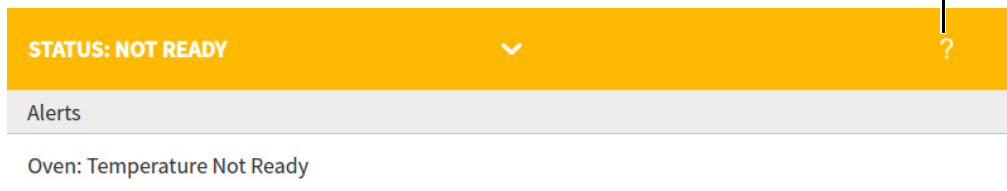

Figure 7 Status/control tray - expanded, with alerts page selected

The tray can be minimized by pressing the arrow on the tray.

Run Controls

The run controls are located on the Status/control tray. The run controls are used to start, stop, and prepare the GC to run a sample.



The **Prep Run** control activates processes required to bring the GC to the starting condition for a run (such as turning off the inlet purge flow for a splitless injection). This is typically required before manual injections to exit any gas saver mode and to prepare the inlet flows for injection.



The **Start** control starts a run after manually injecting a sample. (When you are using an automatic liquid sampler or gas sampling valve, the run is automatically activated at the appropriate time.)



The **Stop** control immediately terminates the run. If the GC is in the middle of a run, the data from that run may be lost.

For details on running methods, see “[Running Methods from the Touch Screen](#)” on page 77.

Entering Data

When you touch a data entry field, a touch keyboard or keypad appears, as applicable. See [Figure 8](#).

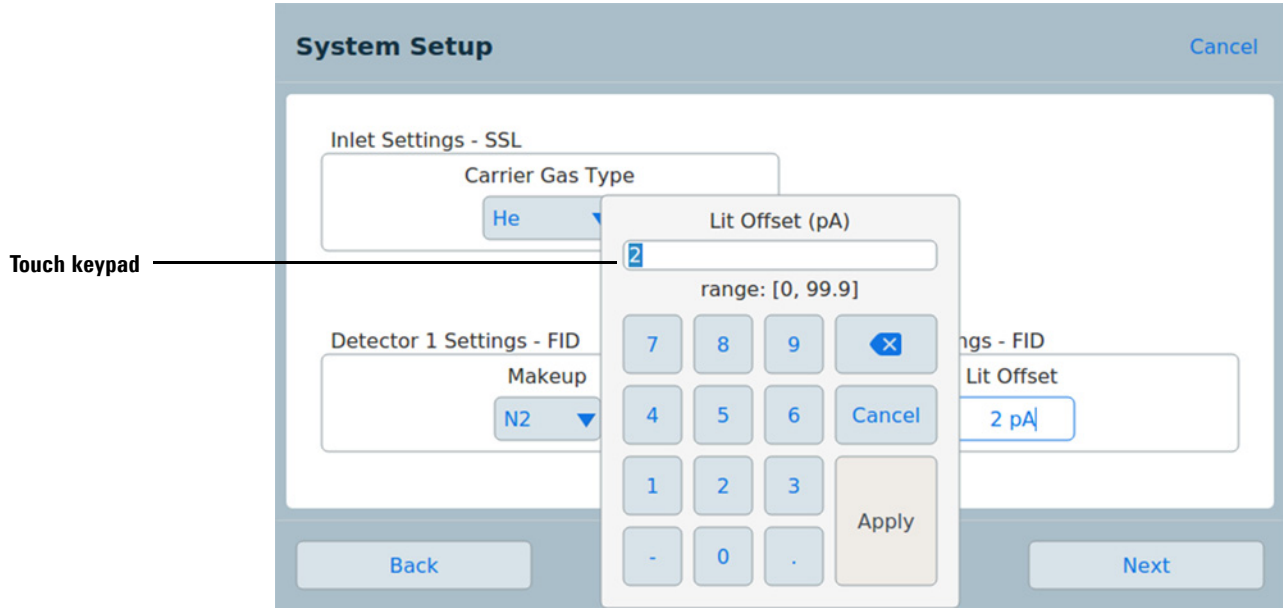

Figure 8 Touch keypad for data entry

If you enter an out of range entry, it is highlighted in a different color.

If the field is a drop-down list box (indicated by a down arrow to the right of the displayed contents of the field), press it to open the list, and then press the desired entry to select it. See [Figure 9](#).

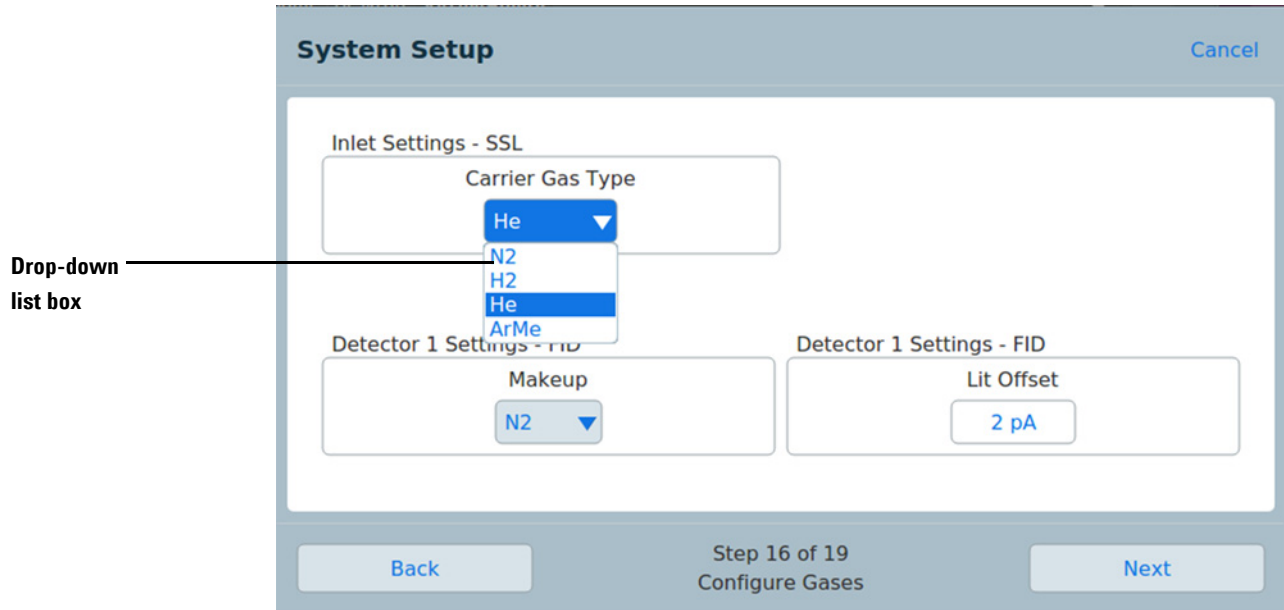

Figure 9 Drop-down list box for data entry

Home View

The home view shows the flow path (including current temperatures and flow rates), run status (including user selectable status items), a real-time plot of the current chromatogram, and related information. See [Figure 10](#).

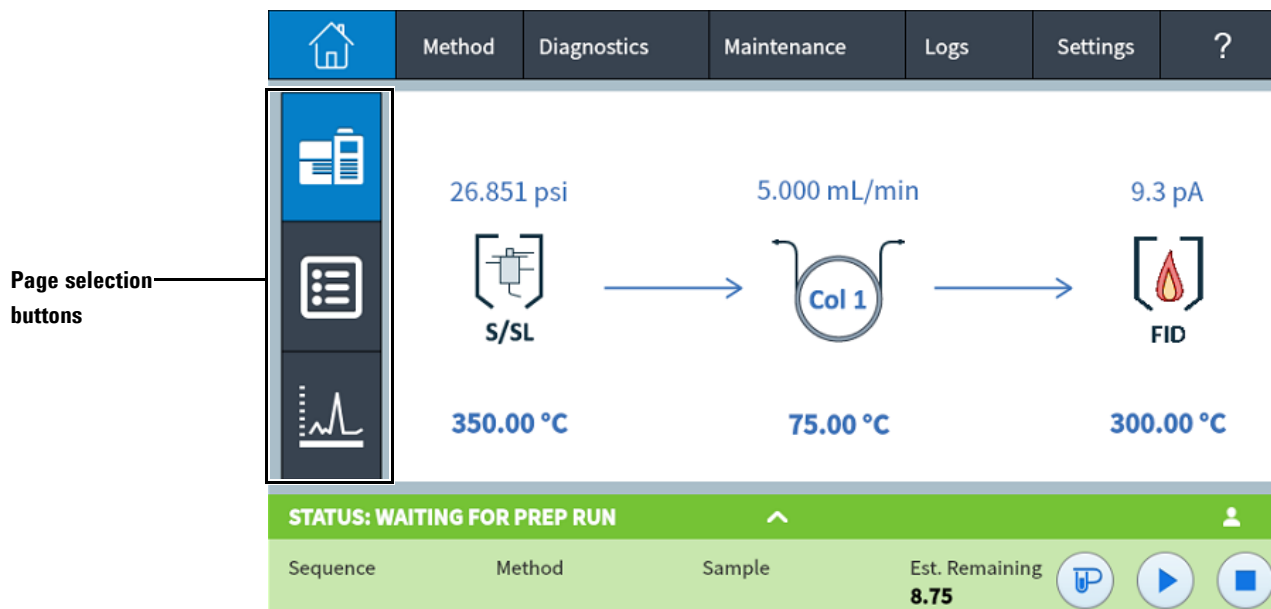

Figure 10 Home view

Three pages are available on the home view:

- Flow path
- Status
- Plot

This displayed page is selected by pressing the corresponding page selection button on the left side of the home view.

Each page is described below.

Flow path page

The flow path page provides details on the sample flow through the GC. This includes visual indications of whether an ALS is installed on the GC, the inlet type, column setup, and detector type, along with corresponding setpoints. See [Figure 11](#).

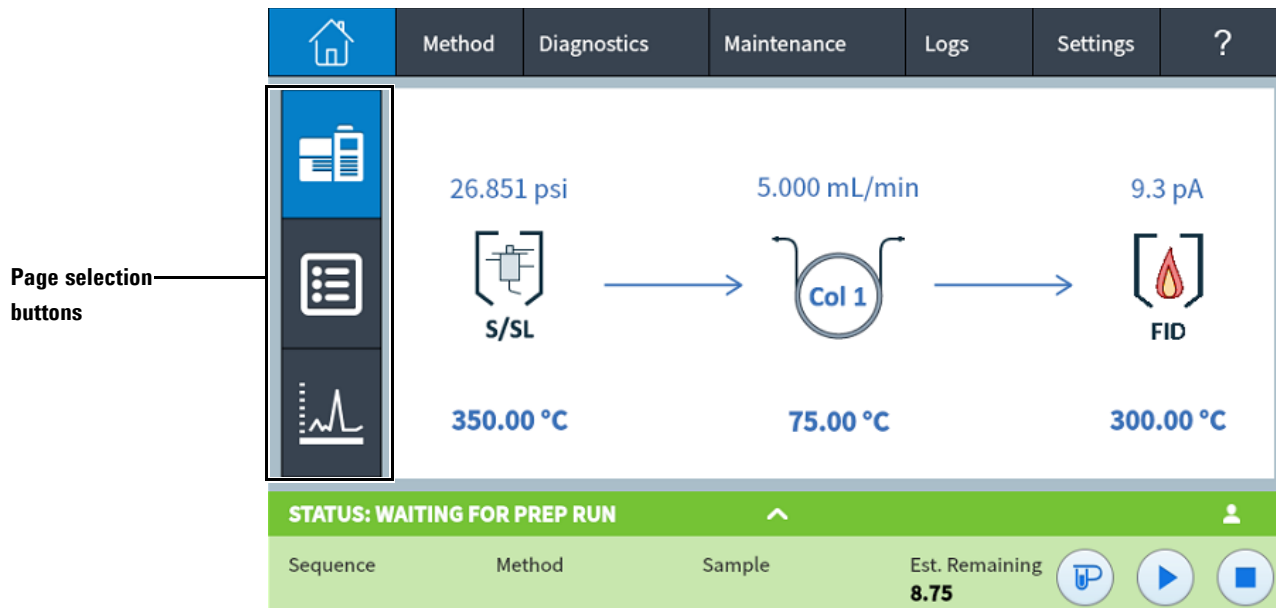

Figure 11 Home view - flow path page

Pressing a setpoint brings up the method editor with the selected setpoint displayed. If the selected setpoint is enabled, the touch keypad used to set the setpoint value is displayed.

Pressing a component, or a setpoint which is not currently enabled, brings up the method editor with the component displayed but without the touch keypad displayed.

See [“Methods and Sequences”](#) on page 59.

When you edit a method in this way, changes are immediately applied when a parameter value is changed, without the need to apply the changes to the GC. This is referred to as On-the-fly editing. See [“Editing a Method”](#) on page 64 for more information.

Status page

The status page displays a user-selectable list of parameters along with their setpoints and actual values. See [Figure 12](#).

Parameter	Setpoint	Actual	+ Add
Little Bus Temperature	300.00 °C	300.02 °C	✕
Main Bus Temperature	300.00 °C	300.00 °C	✕
Oven Temperature	75.00 °C	75.00 °C	✕
Inlet Total Flow	28.000 mL/min	28.001 mL/min	✕

STATUS: WAITING FOR PREP RUN				^	👤	
Sequence	Method	Sample	Est. Remaining	🔍	▶	■
			8.75			

Figure 12 Home view - status page

Pressing the + **Add** button brings up a dialog box which allows you to select a parameter to add to the displayed list. See [Figure 13](#).

Actual Selection ✕

Detector 1 Makeup Flow ▼

Cancel Add

Figure 13 Status page dialog box for adding parameters

Pressing the **X** button on the right side of a parameter entry brings up a confirmation dialog box that allows you to remove the corresponding parameter from the page.

Plot page

The plot page displays a plot of the currently selected signal. See [Figure 14](#).

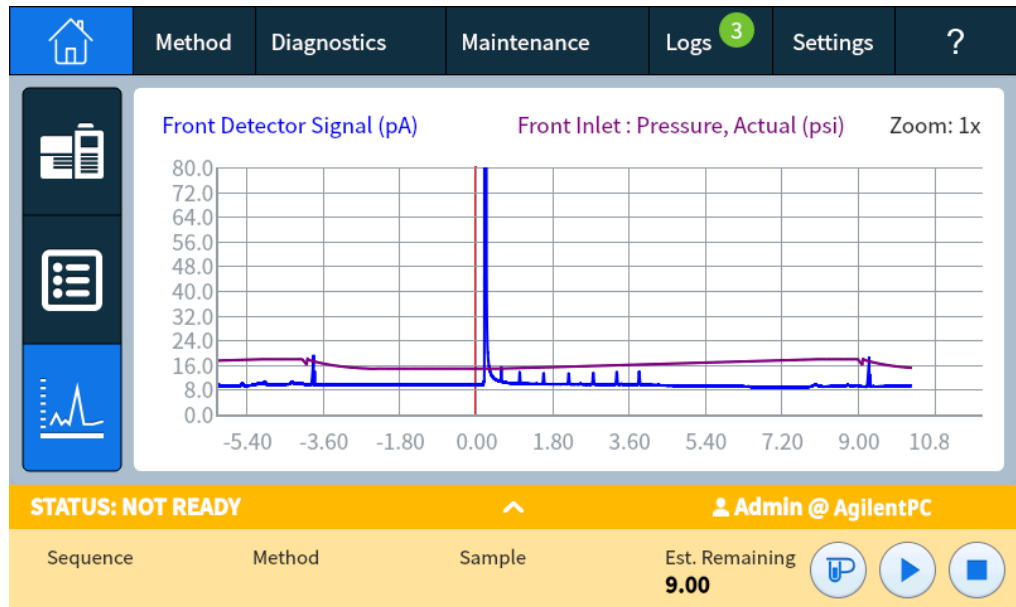

Figure 14 Home view - plot page

Pressing the plot cycles the displayed zoom between **1x**, **2x**, and **4x** at the point where the plot is pressed.

Pressing the displayed signal name opens a Plot Options dialog box. This allows you to select which signal to display. See [Figure 15](#).

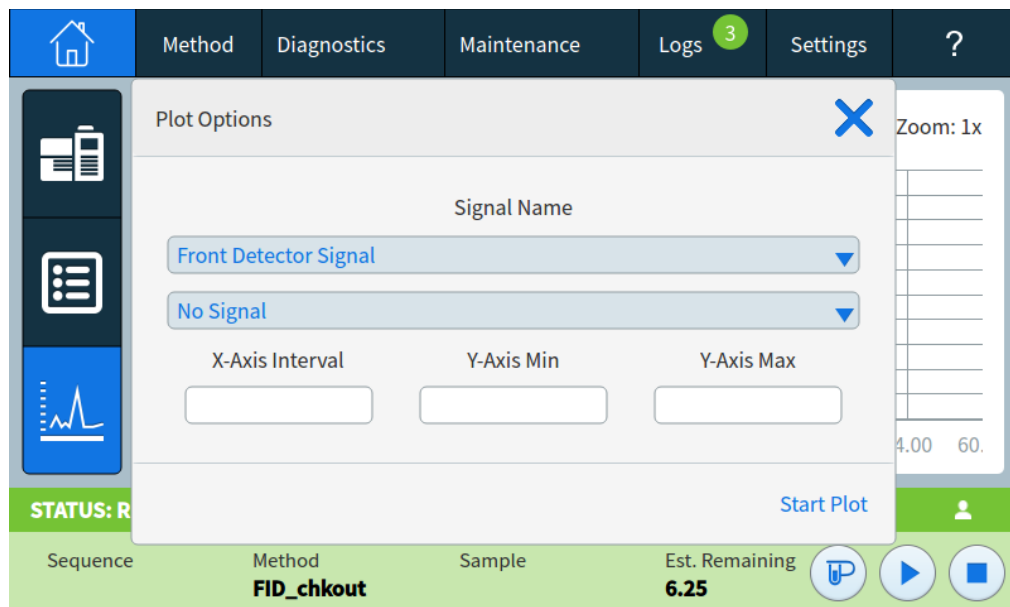

Figure 15 Plot Options dialog box

Use the **Signal Name** drop down list box to select which parameter to display on the plot.

The displayed **X-Axis** interval is 1 to 60 minutes. The **Y-Axis Range** is 0 to infinity. Pressing either field brings up a touch keypad which allows you to set the corresponding value.

If the plot is not currently running, pressing **Start Plot** starts it. If the plot is currently running, pressing **Stop Plot** halts data collection and display. (When changing the Signal Name, it may be necessary to press **Stop Plot** and then **Start Plot** to get the signal to display.)

Methods View

The Methods view provides access to the locally-stored method (Active Method). Use this view shown in [Figure 16](#) to edit the Active Method.

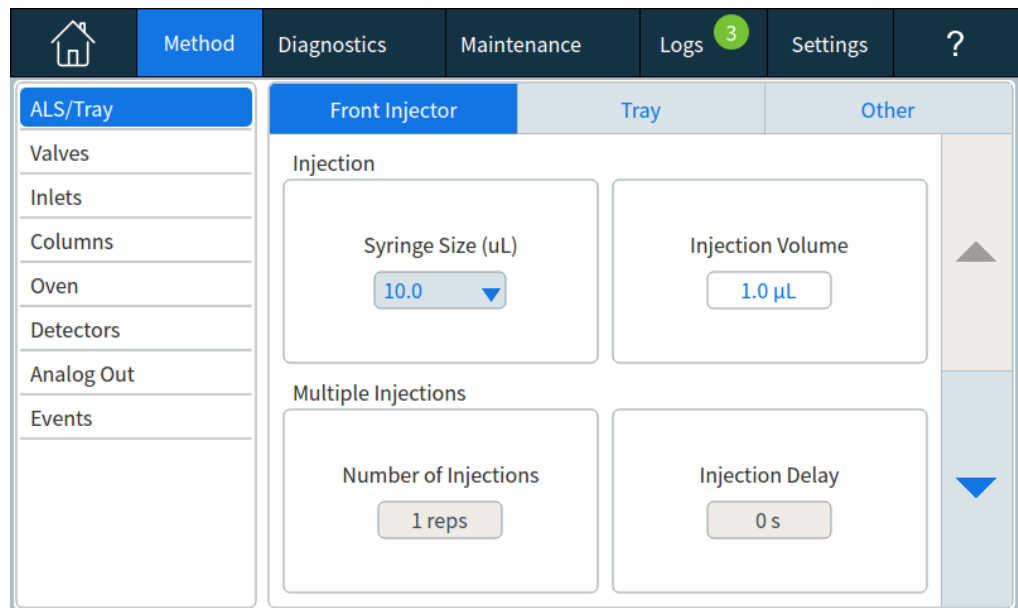

Figure 16 Methods view

Sequence View

If enabled in the browser interface, the Sequence view provides controls to load and execute an existing sequence. Note that when present, the touchscreen tabs change. See [Figure 17](#) below.

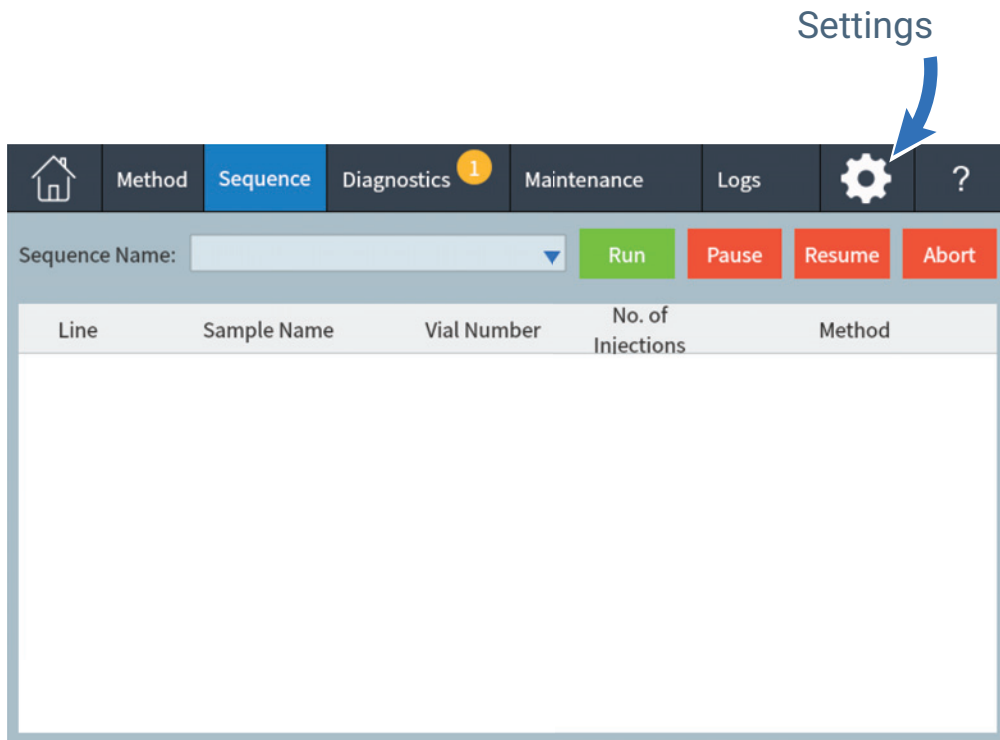

Figure 17 Sequence view

Diagnostics View

The Diagnostics view provides access to diagnostic tests for the installed inlet and detectors. See [Figure 18](#).

Additionally, the view provides a list of all current alerts.

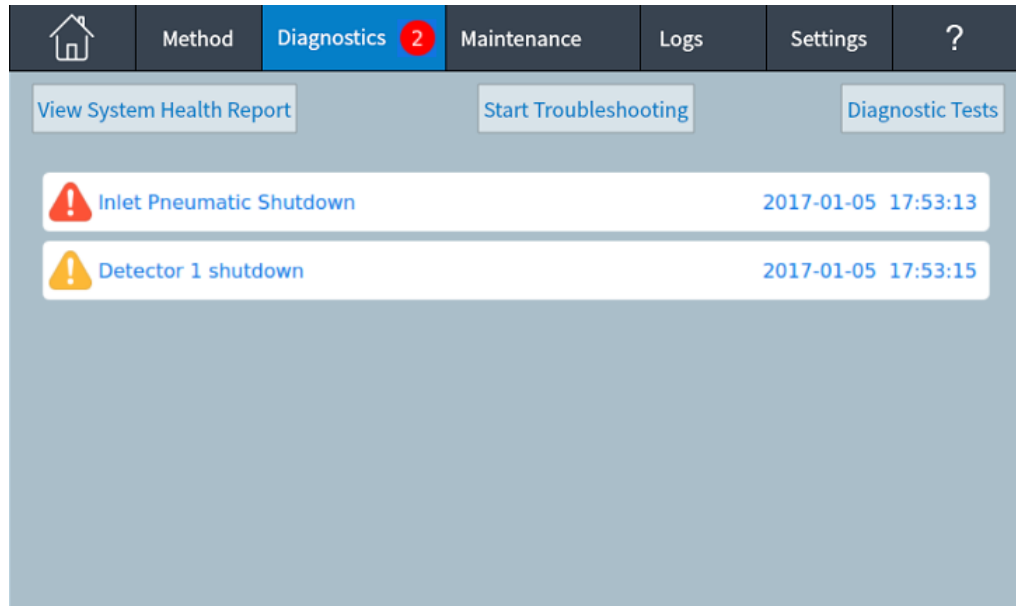

Figure 18 Diagnostics view

See “[Diagnostics](#)” on page 81 for details.

Maintenance View

The Maintenance View provides access to the Agilent Intuvo 9000 GC Early Maintenance Feedback (EMF) features. See [Figure 19](#).

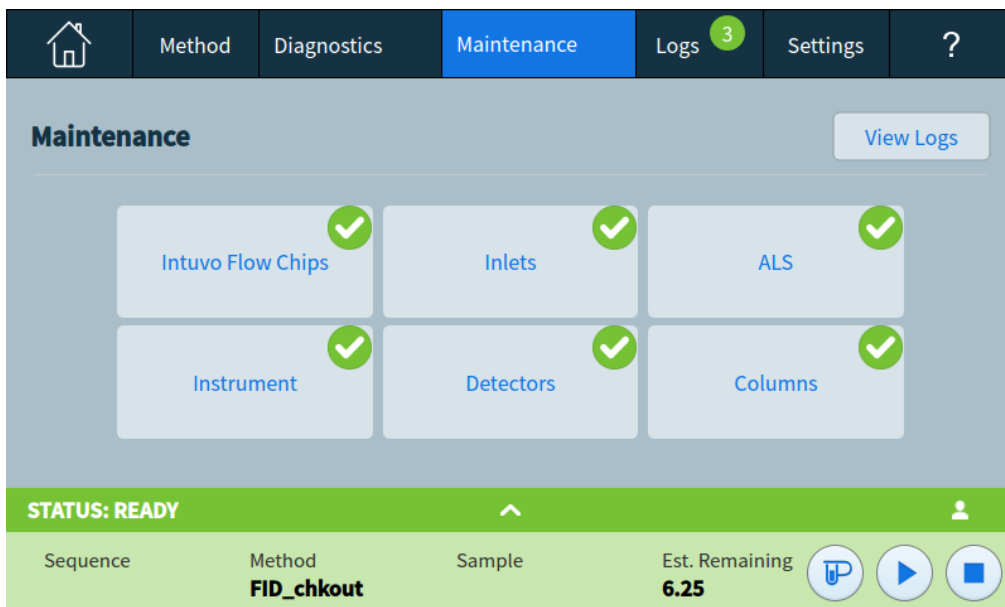

Figure 19 Maintenance view

EMF provides injection-, run-, and time-based counters for various consumable and maintenance parts, as well as the instrument itself. Use these counters to track usage of GC components. Replace or recondition items before potential degradation impacts chromatographic results.

The Maintenance view provides visual indications of maintenance status and is used to track and perform maintenance tasks. See “[Early Maintenance Feedback \(EMF\)](#)” on page 90 for details.

The **View Logs** button brings up the Maintenance Log from the Logs view. See “[Logs View](#)” on page 51.

Logs View

The Logs view provides listings of GC events including maintenance events, run events, sequences, and system events, sorted by date/time. See [Figure 20](#).

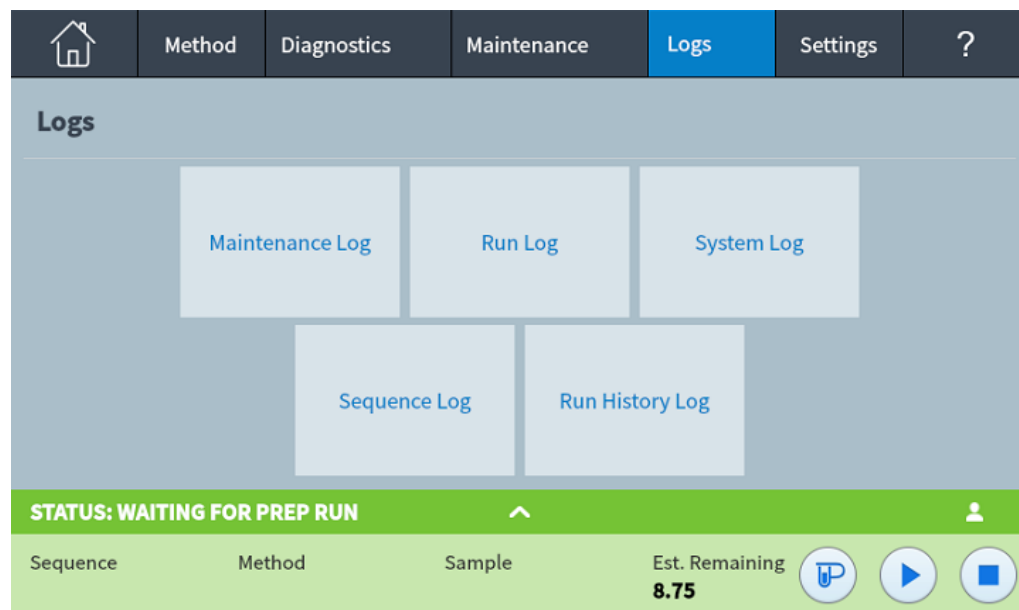

Figure 20 Logs view

See [“Logs”](#) on page 101 for more details.

Settings View

The Settings View provides access to instrument configuration functions, scheduler functions, service mode settings, calibration settings, system settings, system tools (browser interface), power controls (restart or shutdown) and system details. See [Figure 21](#).

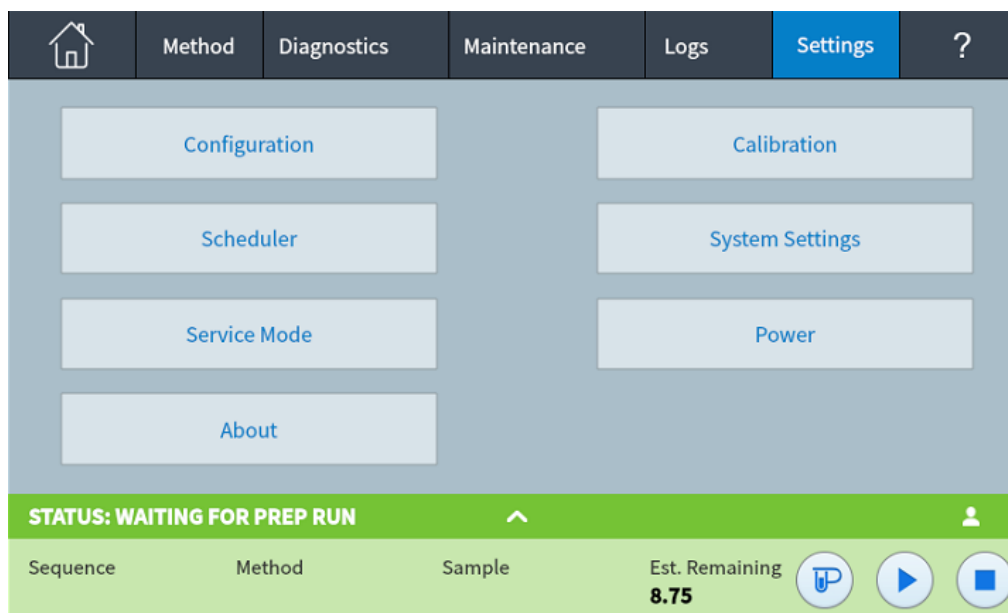

Figure 21 Settings view

Note that if the Sequence view is enabled in the browser interface, the Settings tab changes to an icon. See [Figure 22](#).

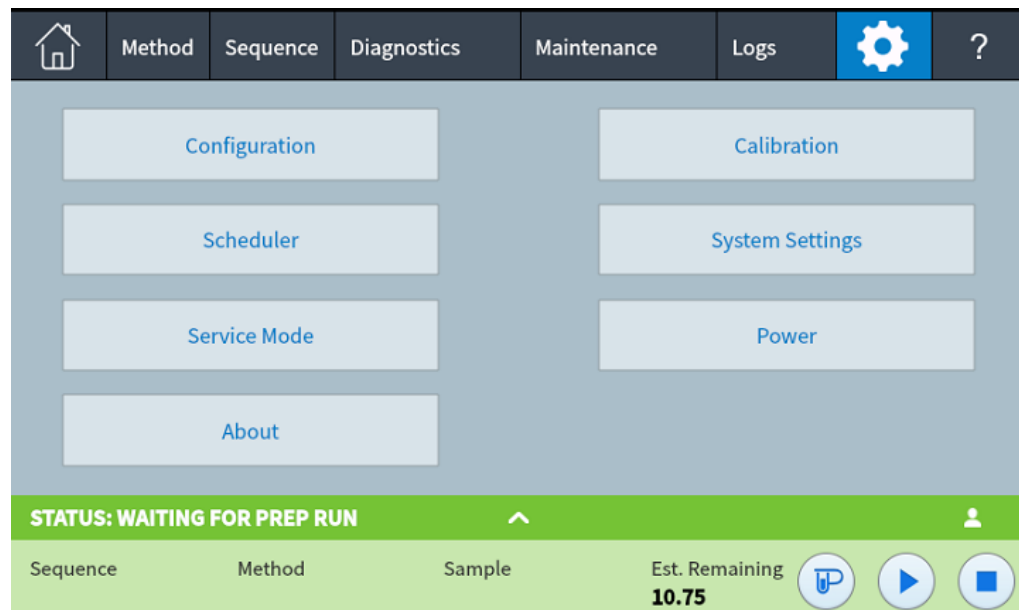

Figure 22 Settings view with sequences enabled

See “Settings” on page 105 for more details.

Touch Screen Functionality When the GC Is Controlled by an Agilent Data System

When an Agilent data system is used to control the GC, the data system defines the setpoints and runs the samples.

NOTE

Be aware that when using an Agilent data system, or the browser UI, the GC touch screen is not locked. The touch screen and connected data system or browser UI are refreshed after any interactions are performed at any source.

When an Agilent data system controls the GC, the touch screen can be used:

- To view run status by selecting the **Home** view
- To view the method settings by using the **Method** view
- To display the last and next run times, the run time remaining, and the post-run time remaining
- To abort a run

Stopping a run using the touch screen immediately ends the run. The data system may retain the data already collected, but no further data is collected for that sample. Agilent data systems may allow the next run to begin, depending on the data system and its settings for handling errors.

Data system changes to the touchscreen

A connected data system can limit the features available at the touchscreen.

These changes can include:

- Disable the touchscreen Start button. (Start is always available for manual injections.)
- Disable real-time plots.
- Disable clock changes.
- Disable data deletion.
- Disable advanced troubleshooting features and diagnostic features, especially those which start diagnostic runs. Automated maintenance and diagnostic procedures will not include steps that require a blank or other confirmation run.

If a feature is disabled, it will appear gray, or will show a lock icon as shown in Figure 23.

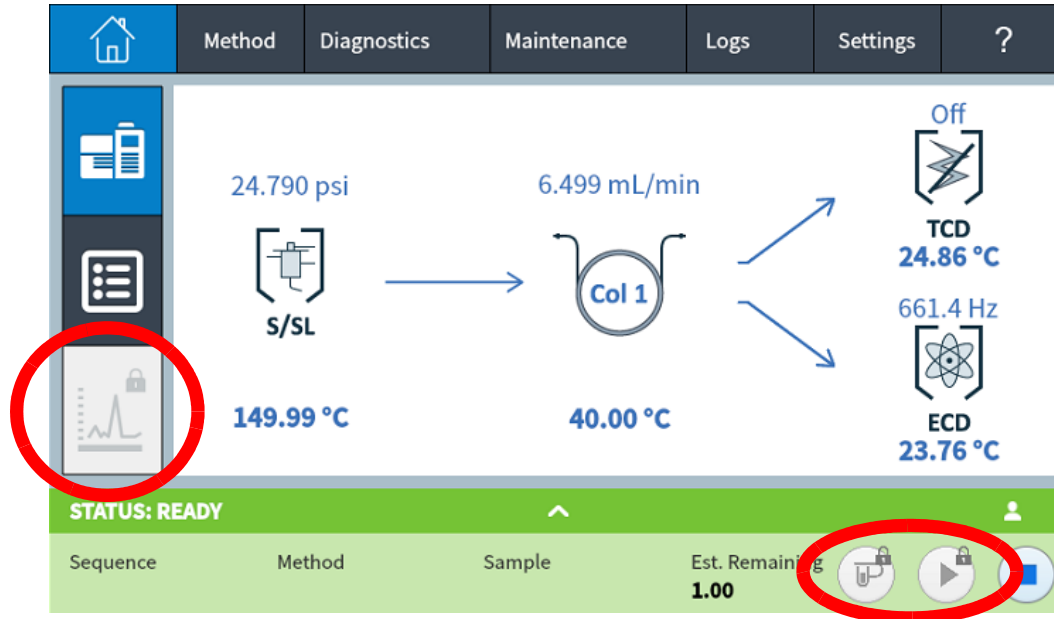

Figure 23 Lock icon indicates a data system is blocking feature

Data system changes to the browser interface

A connected data system can limit the features available at the browser.

These changes can include:

- Disable sequence controls. The Sequence tab will not be available.
- Disable real-time plots.
- Disable data deletion.
- Disable advanced troubleshooting features and diagnostic features, especially those which start diagnostic runs. Automated maintenance and diagnostic procedures will not include steps that require a blank or other confirmation run.

If a feature is disabled, it will appear gray, or will show a lock icon.

These features will be still available through the data system.

GC Status

When the GC is ready to begin a run, the touch screen shows **STATUS: READY**. Alternately, when a component of the GC is not ready to begin a run, the touch screen shows **STATUS: NOT READY** and the **Not Ready** indicator is lit on the GC front panel. Pressing the **Diagnostics** tab displays indications of why the GC is not ready.

Status colors and details

Colors provide quick GC status:

Ready (all settings at setpoint)	STATUS: NORMAL
Run in progress	STATUS: RUN
Not ready	STATUS: NOT READY
Maintenance mode (an automated maintenance task is running)	STATUS: MAINTENANCE MODE
Preparing sample	STATUS: PREPARING SAMPLE
GC is in sleep mode	STATUS: SLEEP
GC is in an error state	

Status text displayed in the status tray can include:

Status text	Comment
CONDITIONING RUN	GC is performing a conditioning run after waking from Sleep.
COOLDOWN	The GC is performing a cooldown between runs.
DIAGNOSTIC MODE	The GC is currently performing a diagnostic test.
ERROR	An error is preventing normal operation. Check the Diagnostics and Logs tabs for more information.
H2 SHUTDOWN	The GC is shut down: heaters are turned off, the oven flaps are open, and gas flows are off.
MAINTENANCE MODE	The GC is running a user maintenance procedure.

Status text	Comment
MSD VENTING	The GC is set to provide flows appropriate for MSD venting.
MSD VENTED	The MSD is vented.
NORMAL	No conditions prevent operation. The GC may or may not be ready to begin a run.
POST RUN	The GC is executing a method post run program.
PREPARING SAMPLE	During a run, a connected ALS is performing sample preparation.
PREP RUN	The GC is in the Prep Run state, preparing for an injection.
RUN	The GC is performing a run.
SLEEP	The GC is in sleep mode. To wake the GC, apply a setpoint change, download a method, or from an Agilent data system select "Wake Up."
SLEEP DEFERRED	Due to ongoing activity, the GC did not enter sleep mode when scheduled. The GC will enter sleep mode after it is has been idle for at least 15 minutes.
SHUTDOWN	A GC component is preventing the GC from operating normally. Check for a diagnostic condition or message at the Diagnostics tab.

Alert tones

The GC provides information via beeps.

A series of warning beeps sounds before a shutdown occurs. The GC starts with one beep. The longer the problem persists, the more the GC beeps. After a short time the component with the problem shuts down, the GC emits one beep, and a brief message is displayed. For example, a series of beeps sounds if the inlet gas flow cannot reach setpoint. The message **Inlet flow shutdown** is briefly displayed. The flow shuts down after 2 minutes.

A continuous tone sounds if a hydrogen flow is shut down, or if a thermal shutdown occurs.

WARNING

Before resuming GC operations, investigate and resolve the cause of the hydrogen shutdown.

One beep sounds when a problem exists, but the problem will not prevent the GC from executing the run. The GC will emit one beep and display a message. The GC can start the run and the warning will disappear when a run starts.

Fault messages indicate hardware problems that require user intervention. Depending on the type of error, the GC emits no beep or a single beep.

Error conditions

If a problem occurs, a status message appears. If the message indicates broken hardware, more information may be available.

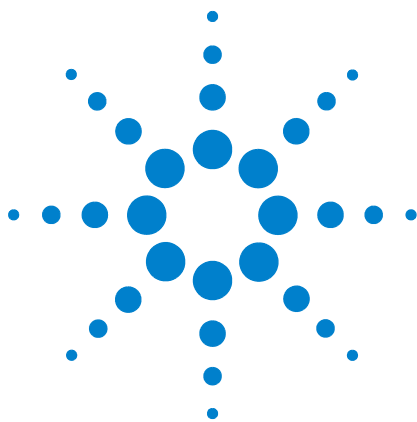

4 Methods and Sequences

What Is a Method?	60
What Is Saved in a Method?	61
What Happens When You Load a Method?	62
View or Edit the Active Method	63
Viewing the Active Method	63
Editing a Method	64
GC Output Signals	65
Analog signals	66
Digital signals	69
Column compensation	72
Test plot	73
Loading a Method	75
Creating a New Method	76
Running Methods from the Touch Screen	77
To manually inject a sample with a syringe and start a run	77
To run a method to process a single sample using an ALS	77
To abort a method	78
What Is a Sequence?	79
Recoverable Errors	80

What Is a Method?

A method is the group of settings required to analyze a specific sample.

Since every type of sample reacts differently in the GC—some samples require a higher column temperature, others require a lower gas pressure or a different detector—a unique method must be created for each specific type of analysis.

The Agilent Intuvo 9000 GC touch screen provides access to a single method, referred to as the *Active Method*.

This method can be edited on the GC using the touch screen.

Additional methods can be created and edited using the connected data system. The connected data system can be used to change the active method on the GC. Methods created on a connected data system are stored by the data system.

NOTE

The connected data system can be used to create wake and sleep methods which are then stored on the GC. Although these methods are not visually displayed on the GC, once downloaded to the GC from the connected data system, they can be used by the GC scheduler functionality. See "[Resource Conservation](#)" on page 146.

What Is Saved in a Method?

Some of the settings saved in a method define how the sample will be processed when the method is used. Examples of method settings include:

- The flow path temperature program
- The type of carrier gas and flows
- The type of detector and flows
- The type of inlet and flows
- The type of column
- The length of time to process a sample

Data analysis and reporting parameters are also stored in an Agilent data system method, for example using OpenLab CDS or MassHunter software. These parameters describe how to interpret the chromatogram generated by the sample and what type of report to print. The GC does not store data analysis and reporting settings.

The GC method also includes ALS setpoints. Refer to the *Installation of the 7693 ALS For the Intuvo 9000 GC* manual for details on setpoints for the supported ALS:

- 7650 GC ALS
- 7693 GC ALS

Current setpoint parameters are saved when the GC is turned off, and loaded when you turn the instrument back on.

What Happens When You Load a Method?

The Agilent Intuvo 9000 GC can store multiple methods. Only a single method, referred to as the Active Method, can be accessed from the touch screen. (This is sometimes referred to as the current method.) The settings defined in this method are the settings the GC is currently maintaining.

When the active method is set from the data system, or when the Active Method is edited on the GC, the setpoints of the Active Method are immediately replaced with the setpoints of the method loaded.

- The selected method becomes the Active Method.
- The Not Ready indicator on the GC front panel lights and remains lit until the GC reaches all of the settings specified by the method that was just made the active method.

View or Edit the Active Method

You can view and edit the Active Method on the GC touch screen.

Viewing the Active Method

To view the Active Method setpoints:

On the touch screen, touch **Methods**. The Methods view appears. See [Figure 24](#).

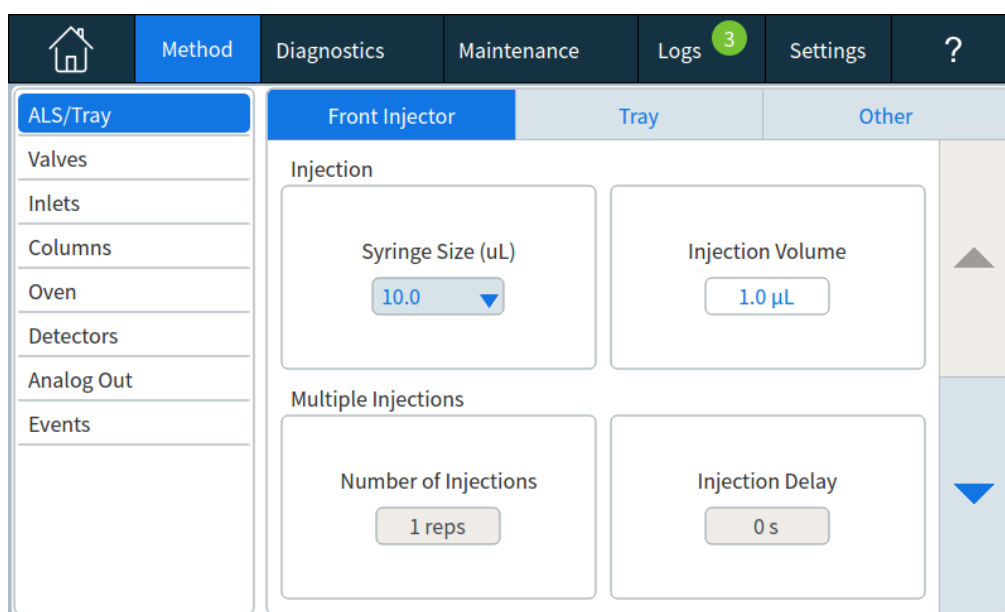

Figure 24 Methods view

The left pane lists the types of parameters as shown in [Figure 24](#). The right pane shows the parameters of the selected type. Note that the parameters shown depend on the current configuration and other method settings. Parameters appear dynamically based on other settings. For example, if using an inlet in splitless mode, you will not see a split ratio setting.

- **Valves:** Displays a listing of possible valve locations along with their type, position, load time, inject time, and whether they are enabled. The Valves selection is always displayed regardless of whether any valves are installed in the GC.
- **ALS:** Displays details for the installed sampler, including all available settings.

- **Inlets:** Displays details for the installed inlet, including all available settings, as well as settings for the guard chip heater and bus heater.
- **Columns:** Displays details for column flow mode, equilibration time, pressure and flow setpoints, and ramp settings.
- **Oven:** Displays details for the oven, including post run temperature, ramp settings, equilibration time, and post run time.
- **Detectors:** Displays settings for the installed detector(s), including heater setpoints, gas flows, carrier gas flow correction settings, and detector specific settings.
- **Analog Out:** Displays analog output settings, including signal types, ranges, zero settings and setpoints.
- **Events:** Displays run-time programmed events, such as valve switching or signal changes.

To make changes or view parameters, touch the parameter type on the left pane, then view or edit its settings in the right pane.

To return to the previous view, do one of the following:

- Press **Apply** to save any changes made to the Active Method in the GC.
- Press **Close** to return to the previous view without applying changes to the GC.

If using an Agilent data system, and you want to keep the changes made, use the data system to upload these changes into the data system method and save them as required.

Editing a Method

The GC allows you to edit methods in two ways:

- Standard editing
- On-The-Fly editing

Standard editing involves making desired changes to the Active Method, and then applying the changes to the GC. This is done as described in [“Viewing the Active Method”](#) on page 63.

On-the-fly changes are immediately applied when a parameter value is changed, without the need to apply the changes to the GC. On-the-fly editing is available when you access a method parameter from the Home view flow path page. See [“Flow path page”](#) on page 43.

GC Output Signals

Signal is the GC output to a data handling device, analog or digital. It can be a detector output or the output from flow, temperature, or pressure sensors. Two signal output channels are provided.

Signal output can be either analog or digital, depending on your data handling device. Analog output is available at either of two speeds, suitable to peaks with minimum widths of 0.004 minutes (fast data rate) or 0.01 minutes (normal rate). Analog output ranges are 0 to 1 V, 0 to 10 V.

To change the analog output settings, touch **Method > Analog Out**.

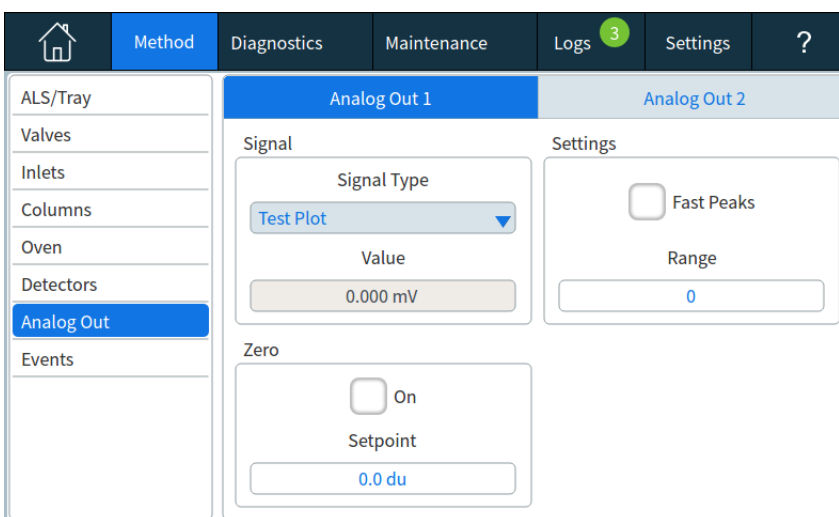

Figure 25 Analog Out Method Setting

Digital output rates are set by your Agilent data system, such as OpenLab CDS or MassHunter Workstation.

See [Table 2](#) for the conversions from units shown on the GC display to units as shown in Agilent data systems and integrators.

Table 2 Signal conversions

Signal type	1 display unit is equivalent to:
Detector:	
FID, NPD	1.0 pA (1.0 ' 10 ⁻¹² A)
FPD+	150 pA (150 ' 10 ⁻¹² A)
TCD	25 μ V (2.5 ' 10 ⁻⁵ V)
ECD	1 Hz
Analog input board (use to connect the GC to non-Agilent detector)	15 μ V
Nondetector:	
Thermal	1 $^{\circ}$ C
Pneumatic:	
Flow	1 mL/min
Pressure	1 pressure unit (psi, bar, or kPa)
Diagnostic	Mixed, some unscaled

When outputting a column pressure signal, the GC reports the pressure in absolute units. For example, an inlet pressure of 68.9 kpa would be reported as 170.2 kpa.

Analog signals

If you use an analog recorder, you may need to adjust the signal to make it more usable. **Zero** and **Range** in the Signal parameter list do this.

Analog zero

Zero Subtracts value entered from baseline. Either select **On** to set Zero at the current signal value, or enter a number between -500,000 and +500,000 as the setpoint to subtract from the baseline.

This is used to correct baseline elevation or offsets. A common application is to correct a baseline shift that occurs as the result of a valve operation. After zeroing, the analog output signal is equal to the **Value** line of the parameter list minus the **Zero** setpoint. **Zero** can be programmed as a run time event.

Analog range

Range Scales data coming from the detector

Range is also referred to as gain, scaling, or sizing. It sizes the data coming from the detector to the analog signal circuits to avoid overloading the circuits (clamping). **Range** scales all analog signals.

If a chromatogram looks like A or B in the next figure, the data needs to be scaled (as in C) so that all peaks are visible on the paper.

Valid setpoints are from 0 to 13 and represent 20 (=1) to 213 (=8192). Changing a setpoint by 1 changes the height of the chromatogram by a factor of 2. The following chromatograms illustrate this. Use the smallest possible value to minimize integration error.

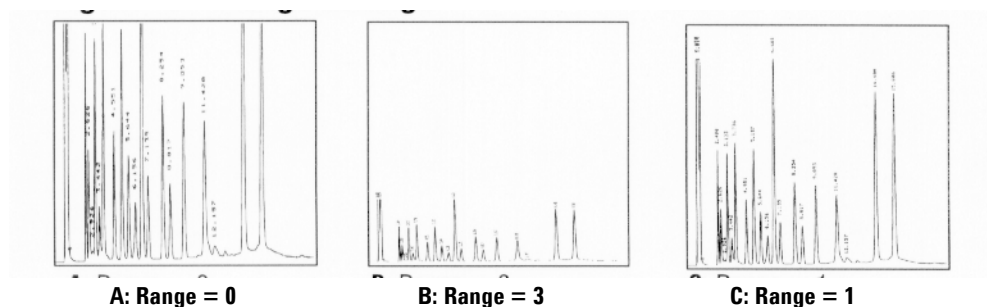

There are limits to usable range settings for some detectors. The table lists the valid range setpoints by detector.

Table 3 Range limits

Detector	Usable range settings (2x)
FID	0 to 13
NPD	0 to 13
FPD+	0 to 13
TCD	0 to 6
ECD	0 to 6
Analog input	0 to 7

Range may be run time programmed.

Analog data rates

Your integrator or recorder must be fast enough to process data coming from the GC. If it cannot keep up with the GC, the data may be damaged. This usually shows up as broadened peaks and loss of resolution.

Speed is measured in terms of bandwidth. Your recorder or integrator should have a bandwidth twice that of the signal you are measuring.

The GC allows you to operate at two speeds. The faster speed allows minimum peak widths of 0.004 minutes (8 Hz bandwidth), while the standard speed allows minimum peak widths of 0.01 minutes (1.6 Hz bandwidth).

If you use the fast peaks feature, your integrator should operate at around 15 Hz.

Selecting fast peaks (analog output)

- 1 Select **Settings > Configuration**.
- 2 Select **Analog Out**.
- 3 Select the checkbox next to **Fast Peaks**.

Agilent does not recommend using **Fast peaks** with a thermal conductivity detector. Since the gas streams switch at 5 Hz, the gain in peak width is offset by increased noise.

Digital signals

The GC outputs digital signals only to an Agilent data system. The following discussions describe features that impact the data sent to data systems, not the analog data available to integrators. Access these features from the data system. These features are not accessible from the GC touchscreen or Browser Interface.

Zero signal

Available only from an Agilent data system.

Digital signal outputs respond to a zero command by subtracting the signal level at the time of the command from all future values.

Signal Freeze and Resume

Available only from an Agilent data system.

Some run time operations, such as changing signal assignments or switching a valve, can cause baseline upsets. Other factors can cause baseline upsets also. The GC can compensate for this by pausing (freezing) the signal at a particular value, using that signal value for a specified duration, and then resuming normal signal output.

Consider a system that uses a switching valve. When the valve switches, an anomaly occurs in the baseline. By freezing and resuming the signal, the anomaly can be removed so that the peak identification and integration software operates more smoothly.

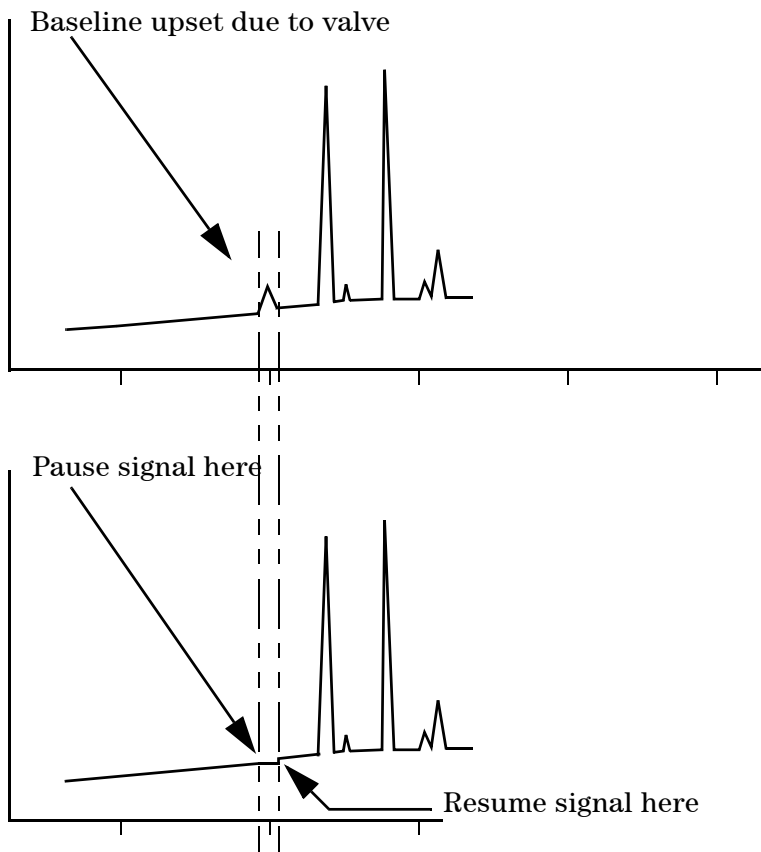

Data rates with Agilent data systems

The GC can process data at various data rates, each corresponding to a minimum peak width. The table shows the effect of data rate selection.

Table 4 Agilent data system data processing

Data rate, Hz	Minimum peak width, minutes	Relative noise	Detector	Column type	
1000	0.0002	6.96	FID/NPD	Narrow-bore, 0.05 mm	
500	0.0004	5	FID/NPD	Narrow-bore, 0.05 mm	
200	0.001	3.1	FID/FPD+/NPD	Narrow-bore, 0.05 mm	
100	0.002	2.2	FID/FPD+/NPD	Capillary	
50	0.004	1.6	ECD/FID/FPD+/NPD	↓	
20	0.01	1	ECD/FID/FPD+/NPD		
10	0.02	0.7	ECD/FID/FPD+/NPD	↓	
5	0.04	0.5	ECD/FID/FPD+/NPD/TCD		to
2	0.1	0.3	ECD		↓
1	0.2	0.22	ECD		
0.5	0.4	0.16	ECD		
0.2	1.0	0.10	ECD		
0.1	2.0	0.07	ECD	Slow packed	

You cannot change the data rate during a run.

You will see higher relative noise at the faster sampling rates. Doubling the data rate can double peak height while the relative noise increases by 40%. Although noise increases, the signal-to-noise ratio is better at the faster rates.

This benefit only occurs if the original rate was too low, leading to peak broadening and reduced resolution. We suggest that rates be chosen so that the product of data rate and peak width in seconds is about 10 to 20.

The figure shows the relationship between relative noise and data rates. Noise decreases as the data rate decreases until you get to data rates of around 5 Hz. As the sampling rate slows, other factors such as thermal noise increase noise levels.

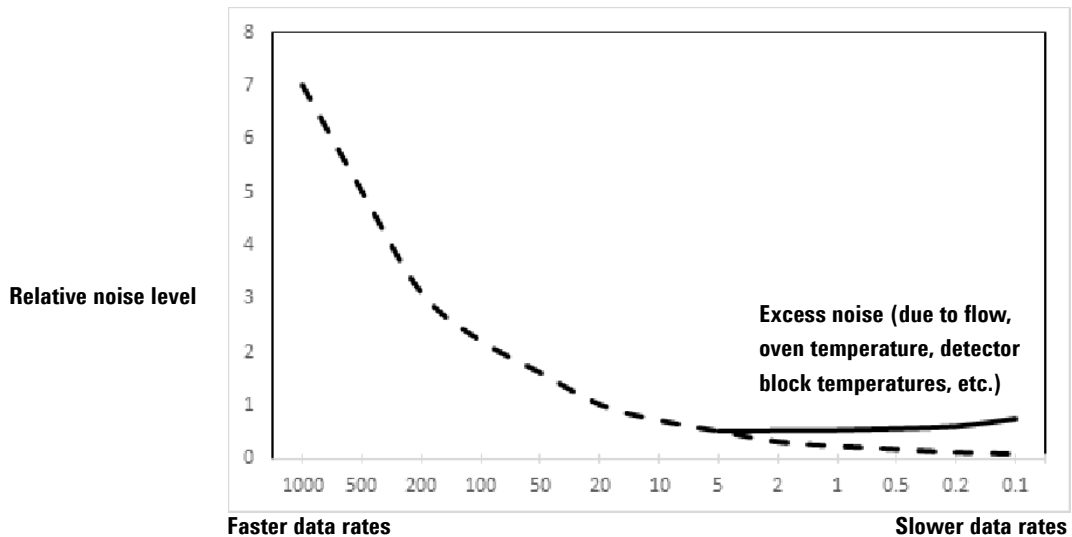

Column compensation

In temperature programmed analysis, bleed from the column increases as the oven temperature rises. This causes a rising baseline which makes peak detection and integration more difficult. Column compensation corrects for this baseline rise.

A column compensation run is made with no sample injected. The GC collects an array of data points from all detectors, whether installed, off, or working. If a detector is not installed or is turned off, that part of the array is filled with zeros.

Each array defines a set of curves, one for each detector, that can be subtracted from the real run to produce a flat baseline. The next figure illustrates the concept.

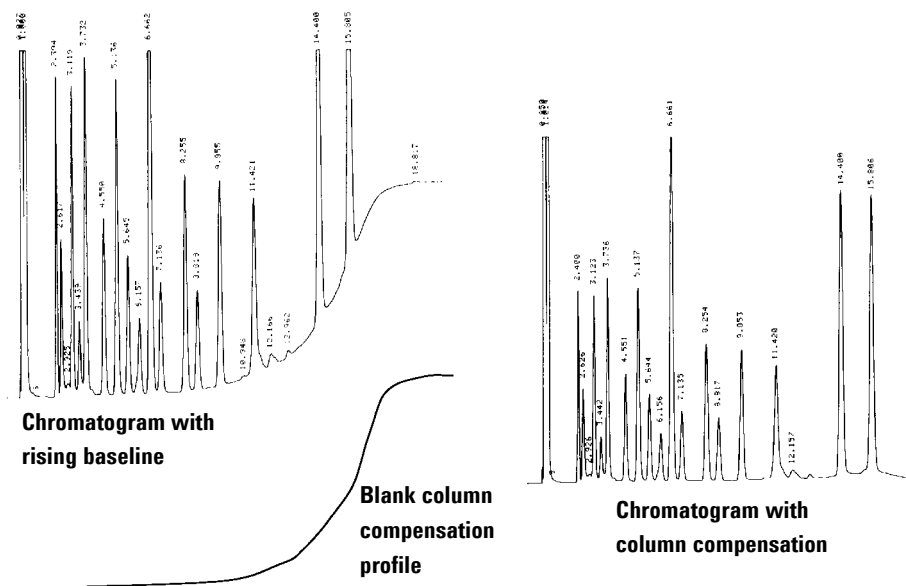

All conditions must be identical in the column compensation run and the real run. The same detector and column must be used, operating under the same temperature and gas flow conditions.

Test plot

Test plot is an internally generated “chromatogram” that can be assigned to a signal output channel. It consists of three baseline-resolved, repeating peaks. The area of the largest is approximately 1 Volt-sec, the middle one is 0.1 times the largest, and the smallest is 0.01 times the largest.

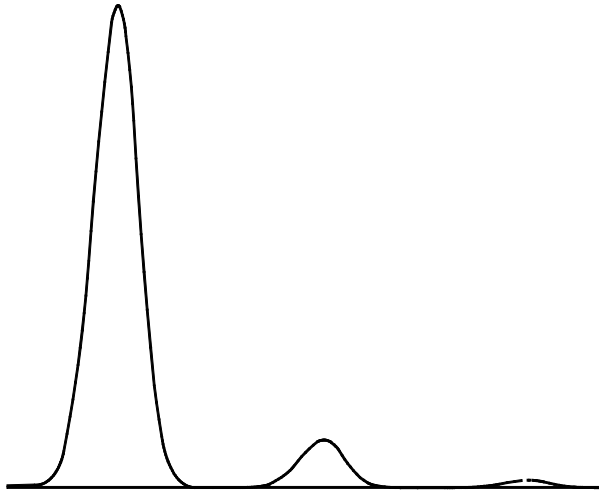

Test plot can be used to verify the operation of external data processing devices without having to perform repeated chromatographic runs. It may also be used as a stable signal to compare the results from different data processing devices.

Test Plot is the default choice for the analog outputs. Test Plot can also be selected as a digital signal when using the Browser Interface or a data system.

Loading a Method

The Active Method can be edited using the GC touch screen. See [“Editing a Method”](#) on page 64.

Additional methods can be created and edited on a connected data system.

You can use the connected data system to set the Active Method on the GC.

Refer to the data system documentation for details on setting the active method from the connected data system.



Creating a New Method

New methods cannot be created from the GC touch screen, although you can edit the active method.

Additional methods can be created and edited on a connected data system or in the browser interface.

Running Methods from the Touch Screen

To manually inject a sample with a syringe and start a run

- 1 Prepare the sample syringe for injection.
- 2 Set the desired method:
 - If connected to a data system, you can load the desired method to the GC. See “[Loading a Method](#)” on page 75.
 - If operating the GC standalone, you can edit the Active Method as desired. See “[Editing a Method](#)” on page 64.
- 3 Navigate to the **Home** view and press **Prep Run** . See “[Run Controls](#)” on page 39 for more information.
- 4 Wait for status **Ready** to display.
- 5 Insert the syringe needle through the septum and all the way into the inlet.
- 6 Simultaneously depress the syringe plunger to inject the sample and press **Start** .

To run a method to process a single sample using an ALS

- 1 Prepare the sample for injection.
- 2 Load the sample vial into the assigned location in the ALS tray or turret.
- 3 Set the desired method:
 - If connected to a data system, you can load the desired method to the GC. See “[Loading a Method](#)” on page 75.
 - If operating the GC standalone, you can edit the Active Method as desired. See “[Editing a Method](#)” on page 64.

Navigate to the **Home** view and press **Start**  to initiate the **ALS syringe cleaning, sample loading, and sample injection method**. After the sample is loaded into the syringe, the sample is automatically injected when the GC reaches the ready state. See “[Run Controls](#)” on page 39 for more information.

Note that the start button can be disabled by a connected data system. See “[Touch Screen Functionality When the GC Is Controlled by an Agilent Data System](#)” on page 54.

To abort a method

- 1 Touch **Stop** .
- 2 When you are ready to resume running analyses, set the desired method:
 - If connected to a data system, you can load the desired method to the GC. See [“Loading a Method”](#) on page 75.
 - If operating the GC standalone, you can edit the Active Method as desired. See [“Editing a Method”](#) on page 64.

What Is a Sequence?

A sequence is a list of samples to be analyzed along with the method to be used for each analysis.

Sequences can be created and edited using a connected data system or browser interface.

Recoverable Errors

Some types of errors, such as an ALS missing vial error or a headspace sampler vial size mismatch, may not always justify stopping an entire sequence. These errors are called *recoverable errors*, since you may be able to recover from them and continue running a sequence, if desired.

When using a connected Agilent data system, you can control how the GC will react to these types of errors. Whether or not the sequence pauses, aborts completely, continues with the next sample, and so on, is set in the sequence for each type of recoverable error.

Note that the data system only specifies what happens to the *next* run in the sequence, not the *current* run, except when set to immediately abort. (In that case, the current run and the sequence is typically aborted.)

For example, pressing the stop button  on the GC touch screen always halts the current run. However, the sequence can be set to continue with the next run, to pause, or to abort the entire sequence.

For details on how this feature works in your data system, refer to its help and documentation.

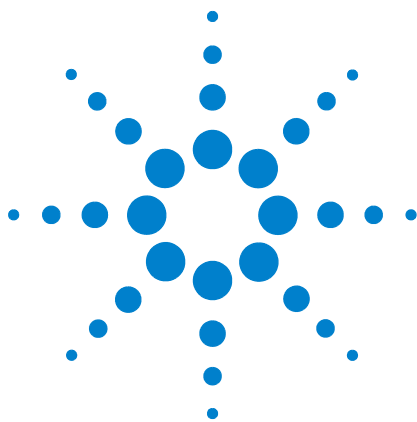

5 Diagnostics

About Diagnostics	82
System health report	82
Automated Testing	83
Using the Diagnostics View	84
Performing Diagnostic Tests	86

About Diagnostics

The GC provides diagnostics features for inlets, detectors, and other installed components. This includes tests that are performed by the operator, and automated testing that is performed by the GC without operator intervention.

The Diagnostics view provides access to the operator initiated diagnostic tests.

Additionally, the view provides a list of all current alerts and the system health report. See [Figure 26](#).

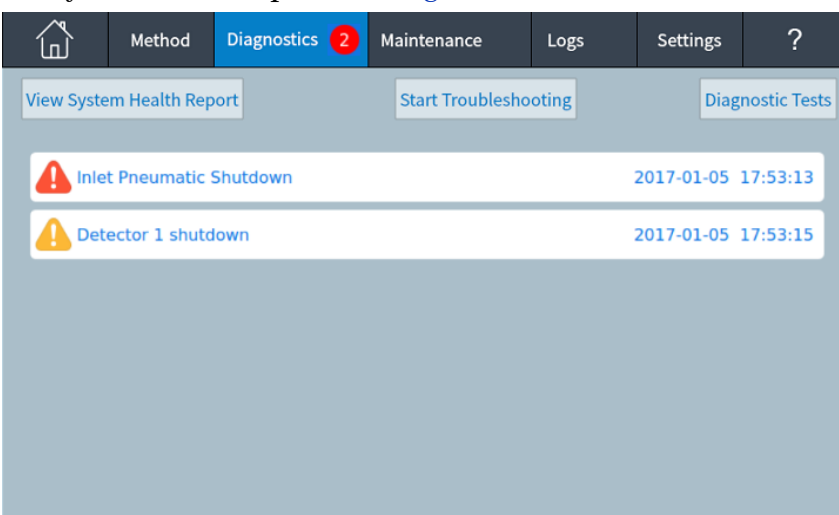

Figure 26 Diagnostics view

System health report

To access the system health report:

- 1 Press **Diagnostics**.
- 2 Press **View System Health Report**.
The system health report appears.

The system health report includes the following types of information:

- System information
- System Configuration details
- Active instrument conditions
- Column details
- Early Maintenance Feedback details
- Diagnostic test results

- Network information
- Status snapshot information

Automated Testing

The GC performs continuous, automated testing of the following items. If a failure occurs, an alert appears on the GC, and an entry is made in the appropriate log.

Detector:

- Supply voltage
- ADC (analog to digital converter) references
- FID flameout
- NPD bead open/short
- Igniter open/short
- Collector short

EPC (Electronic Pneumatic Control)

ADC (analog to digital converter) references

Actuator movements

Thermal:

- Sensor open/short
- Missing heater
- Wrong heater
- Heater current:
 - Quiescent
 - Leakage

Configuration Mismatch

Using the Diagnostics View

To use the Diagnostics view:

- 1 On the touch screen, press **Diagnostics**. The Diagnostics view appears. See [Figure 26](#). The view provides a list of all current alerts.
- 2 Press **Diagnostic Tests**. The Diagnostic Tests page appears.

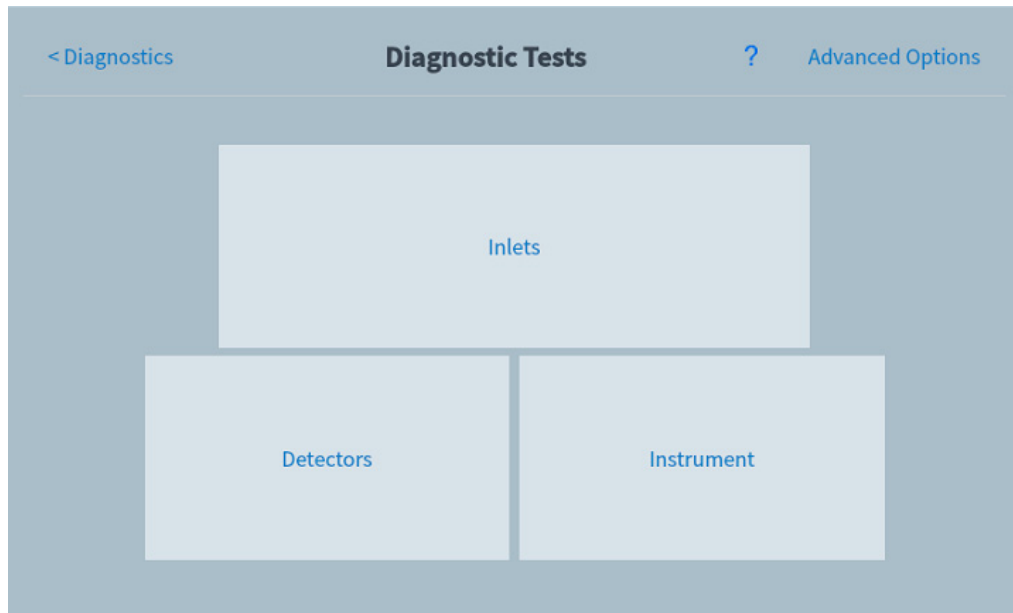

Figure 27 Diagnostic Tests page

- 3 Press **Inlets**, **Detectors** or **Instrument**, as desired. The corresponding page will appear. For example, pressing **Inlets** brings up the Inlet Diagnostic Tests page. See [Figure 28](#).

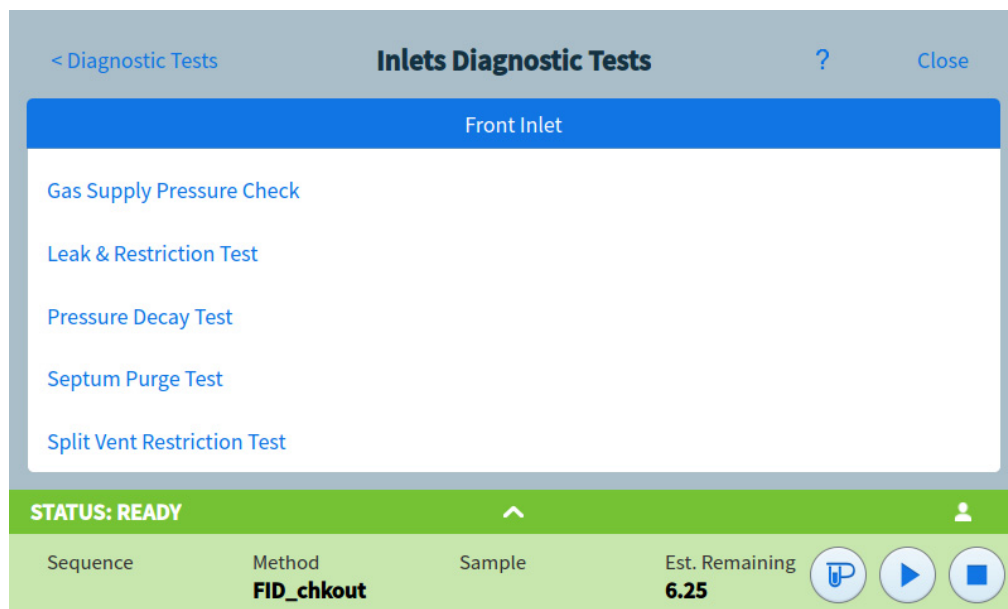

Figure 28 Inlet Diagnostic Tests page

Performing Diagnostic Tests

To perform a diagnostic test:

- 1 Access the desired test from the Diagnostics view. See “Using the Diagnostics View” on page 84.
- 2 Press the desired test. The corresponding test page appears. The test page includes a test description and an indication of the parameter being tested. See Figure 29.

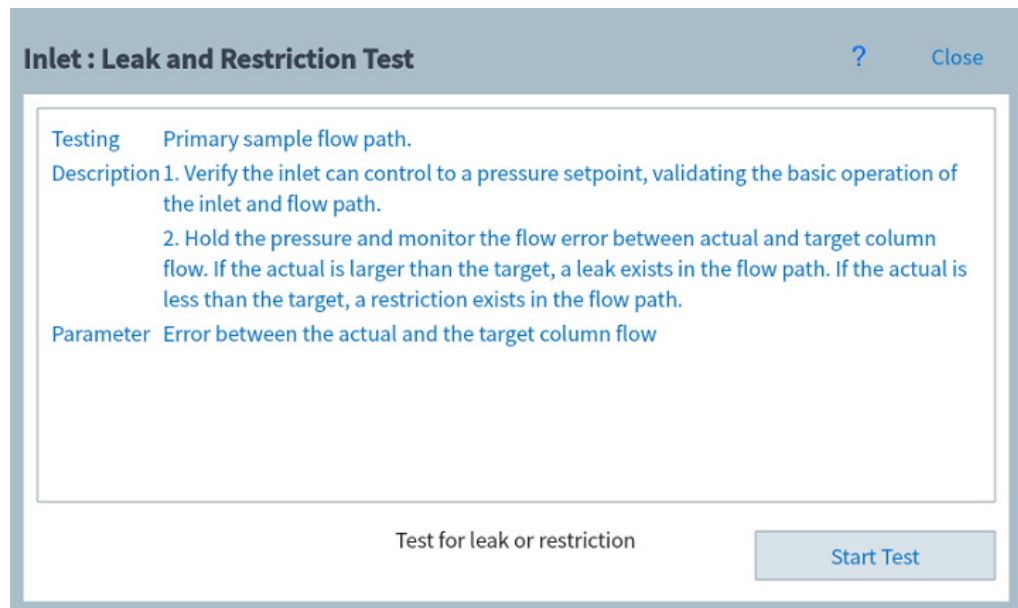

Figure 29 Leak & Restriction Test page

- 3 Press **Start Test**. Testing is initiated. Test details are displayed along with test results. See Figure 30.

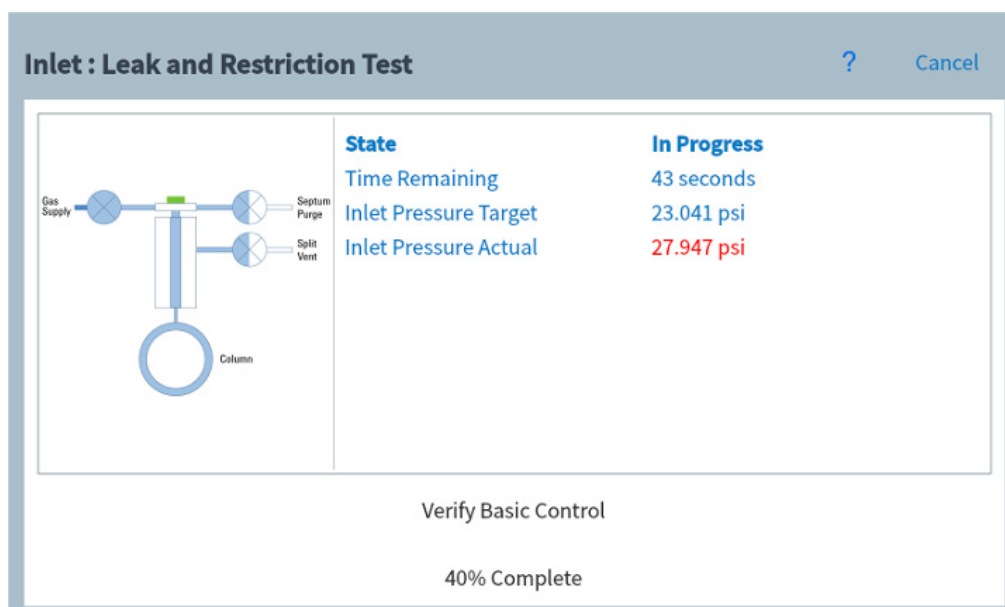

Figure 30 Leak & Restriction Test page

The currently running test can be aborted by pressing **Cancel**. This brings up a dialog box which allows you to confirm that you want to cancel the test. See [Figure 31](#).

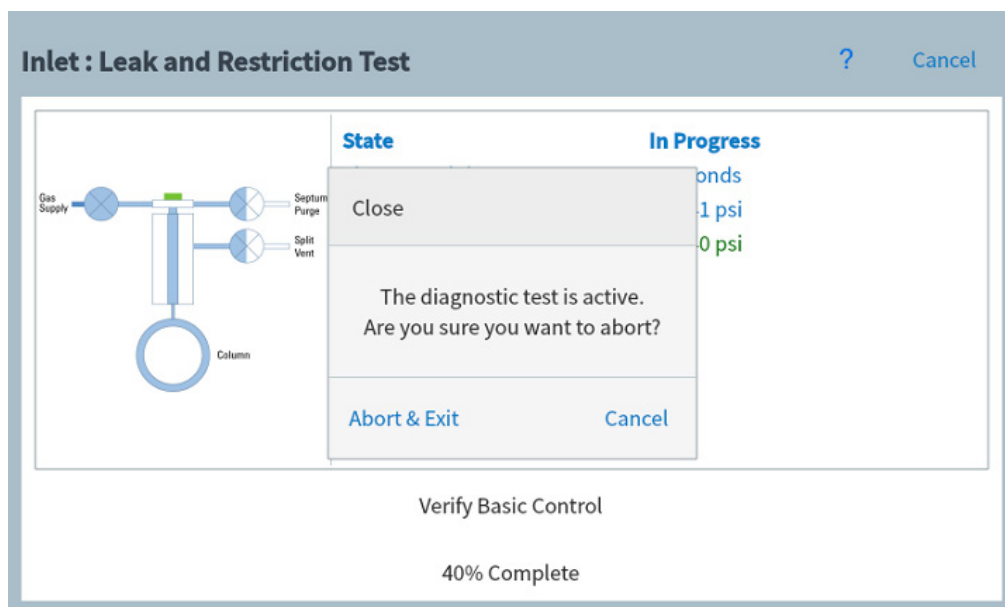
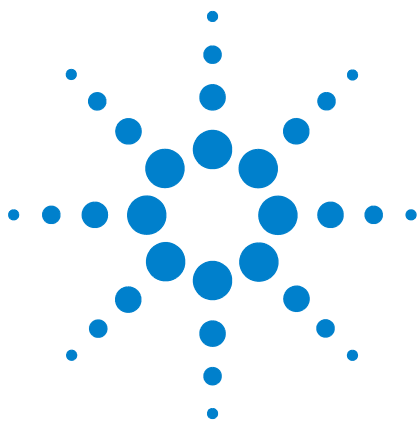

Figure 31 Abort dialog box



6 Early Maintenance Feedback

Early Maintenance Feedback (EMF)	90
Counter types	90
Thresholds	90
Default Thresholds	91
Available Counters	92
Viewing Maintenance Counters	95
To Enable, Reset, or Change a Limit for an EMF Counter	96
EMF Counters for Autosamplers	99
Counters for 7693A and 7650 ALS with EMF-enabled firmware	99
Counters for ALS with earlier firmware	99
EMF Counters for MS Instruments	100

This section describes the Early Maintenance Feedback features available on the Agilent Intuvo 9000 GC.



Early Maintenance Feedback (EMF)

The GC provides injection-, run-, and time-based counters for various consumable and maintenance parts, as well as the instrument itself. Use these counters to track usage so that items can be replaced or reconditioned before potential degradation impacts chromatographic results.

If using an Agilent data system, these counters can be set and reset from within the data system.

Counter types

Counters are provided for injections, runs, and time. Each type is described below.

Injection counters increment whenever an injection occurs on the GC via an ALS injector, headspace sampler, or sampling valve. Manual injections do not increment counters. The GC only increments counters associated with the injection flow path.

Run counters increment against the number of runs performed on the GC.

Time counters increment against the GC clock. Changing the GC clock changes the age of tracked consumables.

Thresholds

The EMF feature provides two warning thresholds: **Service Due** and **Service Warning**. When either threshold is passed, an indication appears on the **Maintenance** button on the GC touch screen ribbon.

Pressing the **Maintenance** button brings up the Maintenance view. See [Figure 32](#).

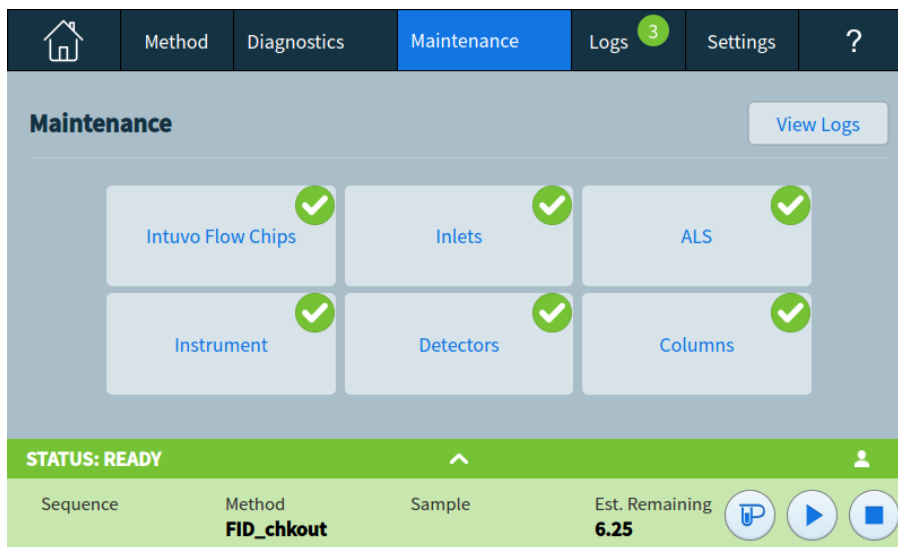

Figure 32 Maintenance view

Selections are available for any installed component.

Two thresholds are settable for any given item:

- **Service Due:** When the counter exceeds this number of injections, runs, or days, a red warning icon appears on the corresponding button, and an entry is made in the **Maintenance Log**.
- **Service Warning:** When the counter exceeds this number of injections or days, an orange warning icon appears on the corresponding button, indicating that the component needs maintenance soon.

Both thresholds are set independently for each counter. You can enable one or both, as desired. The **Service Due** limit must be larger than the **Service Warning** limit.

Default Thresholds

Selected counters have default thresholds to use as a starting point.

If you want to change a default limit, enter a conservative limit based on your experience. Use the warning feature to alert you when service is approaching, then track performance to determine if the **Service Due** threshold is too high or too low.

For any EMF counter, you may need to adjust the threshold values based on the demands of your applications.

Available Counters

Table 5 lists the most common counters available. The available counters will vary based on the installed GC options and consumables.

Table 5 Common EMF counters

GC Component	Parts with a counter	Type	Service Warning Default Value	Service Due Default value
Inlets				
SSL	Septum	Number of injections	160	200
	Liner	Number of injections	160	200
	Liner O-ring	Number of injections	800	1000
	Split vent trap	Number of injections	8,000	10,000
	Top weldment o-ring	Number of injections	8,000	10,000
	Liner	Time	24 days	30 days
	O-ring	Time	48 days	60 days
	Split vent trap	Time	148 days	185 days
	Top weldment insert o-ring	Time	48 days	60 days
	Guard chip	Number of injections	80	100
	Guard chip	Time	72 days	90 days
MMI	Liner	Number of injections		200
	Liner	Time		30 days
	Liner O-ring	Number of injections		1000
	Liner O-ring	Time		60 days
	Septum	Number of injections		200
	Split vent trap	Number of injections		10,000
	Split vent trap	Time		6 months
	Cooling cycles	Number of injections		
Clean bottom seal	Number of injections		1000	
Columns				
	Injections onto column	Number of injections	200,000	250,000
	Run count	Number of runs	200,000	250,000
	Time over programmed max	Time	20 days	25 days

Table 5 Common EMF counters (continued)

GC Component	Parts with a counter	Type	Service Warning Default Value	Service Due Default value
	Time over max temperature	Time	20 days	25 days
	Max applied temperature	Degrees C	360	450
	On time	Time	388.2 days	485.25 days
	Actuations	Cycles	200,000	250,000
Intuvo Flow Chips (Bus)				
	Injections	Number of injections	200,000	250,000
	Run count	Number of runs	200,000	250,000
	Time over max temperature	Time	20 days	25 days
	Max applied temperature	Degrees C	360	450
	On time	Time	388.2 days	485.25 days
Detectors				
FID	Collector assembly	Number of injections	200,000	250,000
	Jet	Number of injections	200,000	250,000
	Ignitor ignitions	Number of ignition attempts	200,000	250,000
	Detector tail	Number of injections	200,000	250,000
	Detector tail	Time	148 days	185 days
TCD	Switching solenoid	On time		
	Filament on time	On time		
	Detector tail	Number of injections	200,000	250,000
	Detector tail	Time	148 days	185 days
ECD	Time since wipe test	On time		6 months
	Detector tail	Number of injections	200,000	250,000
	Detector tail	Time	148 days	185 days
NPD	Bead	Number of injections		
	Ceramics	Number of injections		
	Bead baseline offset	pA Value		
	Applied bead current	Amps		
	Bead current integral	pA-sec Value		

Table 5 Common EMF counters (continued)

GC Component	Parts with a counter	Type	Service Warning Default Value	Service Due Default value
	Bead on time	On time		Bios bead: 2400 h
	Detector tail	Number of injections	200,000	250,000
	Detector tail	Time	148 days	185 days
FPD ⁺	PMT	Number of injections		
	PMT	On time		6 months
	Detector tail	Number of injections	200,000	250,000
	Detector tail	Time	148 days	185 days
Valves				
Valve	Rotor	Activations (number of injections)		
	Maximum temperature	Value		
Instrument				
Instrument	Instrument on time	Time	730 days	912.5 days
	Instrument run count	Number of runs	200,000	250,000
	Gas filter maintenance	Time	148 days	185 days
	Disk usage	Percentage	68%	85%
	Instrument run time	Time	730 days	912.5 days
ALS Injectors				
ALS	Syringe	Number of injections		800
	Syringe	Time		2 months
	Needle	Number of injections		800
	Plunger moves	Value		6000
Mass spectrometers				
Mass spectrometer	Pump	Time (days)		1 year
	Filament 1	Time (days)		1 year
	Filament 2	Time (days)		1 year
	Source (time since last cleaning)	Time (days)		1 year
	EMV at last tune	V		2600

Viewing Maintenance Counters

To view the maintenance counters:

- 1 Press the **Maintenance** button on the GC touch screen ribbon. The Maintenance screen appears. See [Figure 32](#) on page 91.
- 2 Press the desired component type on the GC touch screen. The selected Maintenance page appears. The Status column lists the counter for the corresponding component. See [Figure 33](#).

Detector 1 - FID		
Part	Status	Reset All
✓ Collector assembly injections	46 injections	▲ ▼
✓ Detector tail age	5 wk 3 days 16 hrs	
✓ Detector tail injections	46 injections	
✓ Ignitor ignitions	25 ignitions	

STATUS: READY ^

Sequence	Method	Sample	Est. Remaining
	FID_chkout		6.25

Figure 33 Detector Maintenance page

- 3 Scroll to view additional components, as applicable.

To Enable, Reset, or Change a Limit for an EMF Counter

When using the GC without a data system, enable or change the limit for a counter as follows:

- 1 Locate the counter you wish to change. See [“Viewing Maintenance Counters”](#) on page 95.
- 2 Select the **Details** listing for the counter you want to change. The dialog includes a trend plot for past reset events for this counter. See [Figure 34](#).

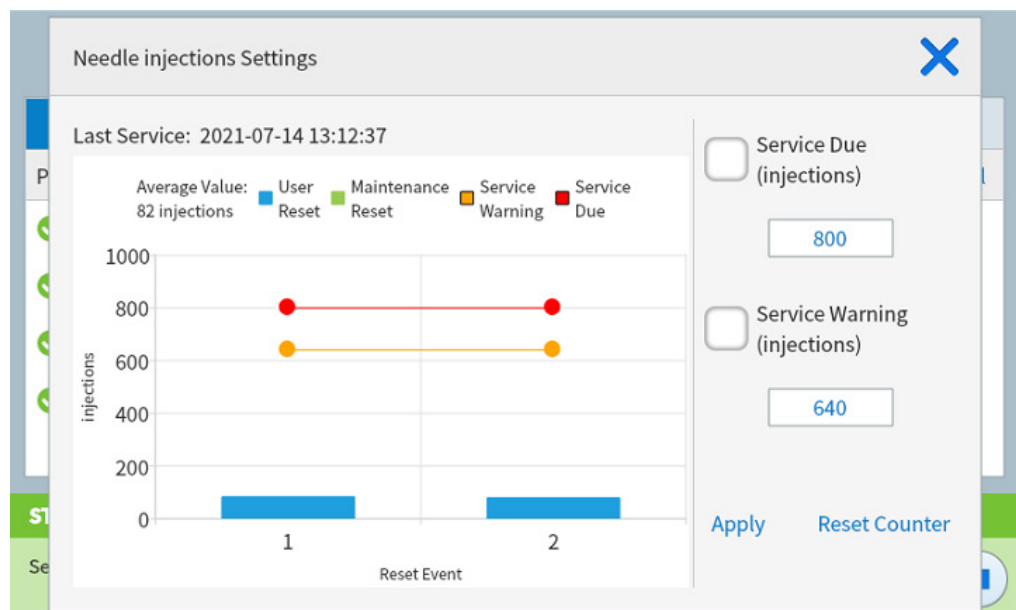

Figure 34 Settings dialog box

The trend plot legend includes the following controls:

- **User Reset:** Select to toggle manual counter resets.
- **Maintenance Reset:** Select to toggle counter resets performed automatically when using an automated maintenance procedure.
- **Service Due:** Select to toggle the Service Due limit on the plot.
- **Service Warning:** Select to toggle the Service Warning limit on the plot.

- 3 To reset the counter:

NOTE

Counters cannot be reset for items which have attached SmartID keys. This includes flow chips, columns, and so on. Counter data is stored in the SmartID key for each component and cannot be manually modified.

- a Press **Reset Counter**. A confirmation dialog box appears.
 - b Press **Yes**. The confirmation dialog box closes.
- 4 To modify a threshold:
 - a Press the threshold entry. A data entry dialog box appears.
 - b Enter the desired value. See “[Default Thresholds](#)” on page 91.
 - c Press **Apply**. The dialog box closes. The entered value is displayed in the corresponding field.
- 5 To enable or disable a warning, select or deselect **Enable** for the corresponding counter.
- 6 Press **Apply**. The Settings dialog box closes.

The GC logs each counter reset. Access this information from the maintenance log.

Note that any change to a Service Due or Service Warning limit does not appear on the plot until the next counter reset.

EMF Counters for Columns

Because GC Columns are sometimes transferred from GC to GC, the EMF counters for GC columns are associated not with the GC, but with the column serial number. This serial number is found from the column's Smart ID key, or the columns database if using an Agilent data system.

- If the column is reconfigured on the same GC, for example, changed from column #1 to column #2, the GC will transfer the EMF data to the new column position, and will continue to cumulatively track EMF data.
- If a column is completely removed from the GC (the current GC configuration no longer includes that column serial number), the GC will track the EMF data for any new column using the new column's data.
- The GC stores column EMF data on the column's Smart ID key or in the columns database. The data in the Smart ID key and columns database do not get reset by the GC.

If not using a Smart ID key or a column database, the column data is available only on the GC while the GC is installed.

- It is important to always enter the column serial number so that EMF data can be tracked for the column.
- Moving a column between configured positions on the same GC maintains the column's EMF counters.
- Column EMF data will not transfer between GCs without a Smart ID key. If using an Agilent data system, column EMF data may not transfer between data system installations (each data system usually has its own columns database).

EMF Counters for Autosamplers

The GC provides access to the counters for an installed autosampler. The functionality for ALS counters depends on the ALS model and firmware version. In all cases, the GC shows EMF counter status, and allows you to enable, disable, and clear the counters using the GC touch screen.

Counters for 7693A and 7650 ALS with EMF-enabled firmware

If using an Agilent 7693 injector with firmware version G4513A.10.8 (or higher), or a 7650 injector with firmware version G4567A.10.2 (or higher), each injector independently tracks its EMF counters.

- The injector counters will increment as long as the injector is used on any Agilent Intuvo 9000 Series GC. You can change positions on the same GC or install the injector on a different GC without losing the current ALS counter data.
- The ALS will report an exceeded limit only when mounted on an Intuvo 9000 Series GC.

Counters for ALS with earlier firmware

If using a 7693 or 7650 injector with earlier firmware, the GC tracks the counters for that injector. The GC uses the injector serial number to distinguish between installed injectors.

Each time the GC detects a new injector (different model or different serial number), the GC resets the ALS counters for the new injector.

EMF Counters for MS Instruments

When configured to an Agilent MS that supports enhanced communications (such as a 5977 Series MSD or 7000C Triple Quadrupole MS), the GC reports the EMF counters as tracked by the MS. The MS provides its own EMF tracking.

When connected to an earlier model MS (for example, a 5975 Series MSD or 7000B MS), the GC tracks the MS counters. The MS itself does not provide its own EMF tracking.

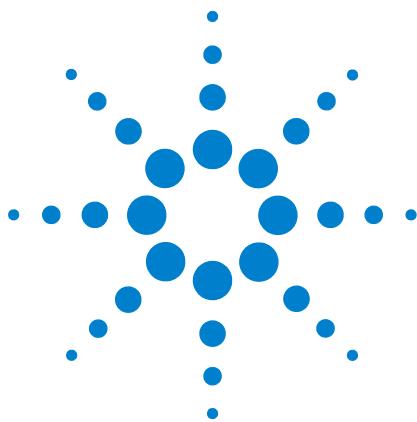

7 Logs

Logs View 102

This section describes the log features available on the Agilent Intuvo 9000 GC.

Logs View

The Logs view provides listings of GC events including maintenance events, run events, system events, sequences events, run history and log for certain connected instruments (such as an 8697 headspace sampler), sorted by date/time. The sequences run log includes sequences run using the browser interface, not sequences run with the data system. See [Figure 35](#).

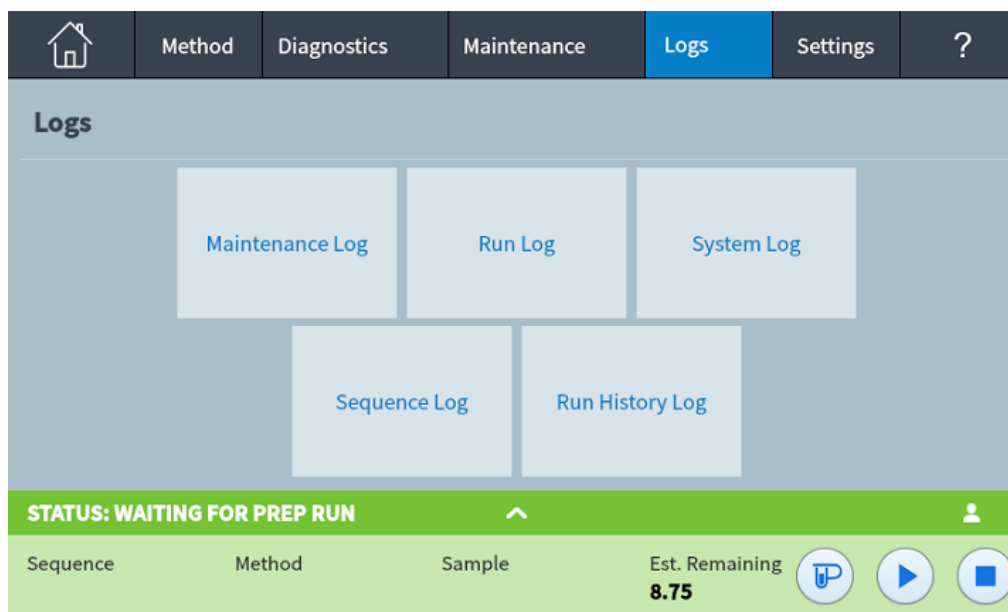

Figure 35 Logs view

Pressing one of the buttons on the Logs view brings up the corresponding log page. See [Figure 36](#).

The screenshot shows a 'Maintenance Logs' window with a title bar containing a question mark and a 'Close' button. The main area is a table with two columns: 'Date/Time' and 'Notes'. The table contains four entries:

Date/Time	Notes
Thu 18 Jul 2019 02:39:35 AM +05	Injector installed (CN13490062)
Wed 03 Nov 1971 12:46:23 PM +05	Backflush Chip installed G4588-60721 (RA9S)
Wed 03 Nov 1971 12:46:21 PM +05	Column 2 installed 19091S-431UI-INT (US18360241)
Wed 03 Nov 1971 12:46:20 PM +05	Column 1 installed 19091S-431UI-INT (US18360240)

Below the table is a green status bar that reads 'STATUS: READY' and includes an upward-pointing arrow and a user icon. At the bottom is a control bar with columns for 'Sequence', 'Method', 'Sample', and 'Est. Remaining'. The 'Est. Remaining' value is '0.53'. To the right of the control bar are three circular icons: a blue square with a white 'P', a blue play button, and a blue square with a white 'X'.

Figure 36 Maintenance Logs page

For Maintenance and System log items, items are sorted by date and time. For Run log items, relative time (from the start of the run) is used.

Use the scroll buttons to scroll through the log entries.

Press **Close** to return to the Logs view.



8 Settings

- About Settings 106
- Service Mode 107
 - Resetting system items 109
- About This GC 111
- Calibration 112
 - Maintaining EPC calibration—inlets, detectors, PCM, and AUX 113
 - To zero a specific flow or pressure sensor 114
- System Settings 115
 - Configuring the IP address for the GC 115
 - To set system date and time 117
 - To change the system locale 118
 - To set system power saving features 119
 - To access stored run data 120
 - To control Browser Interface access 121
 - To change the remote advisor settings 122
 - To run the system setup routine 125
- Tools (Browser Interface) 126
 - Performing a Column Compensation Run 127
- Power Options 128



About Settings

The Settings view provides access to configuration and system settings for the GC.

Pressing **Settings** on the touch screen control ribbon brings up the Settings view. See [Figure 37](#).

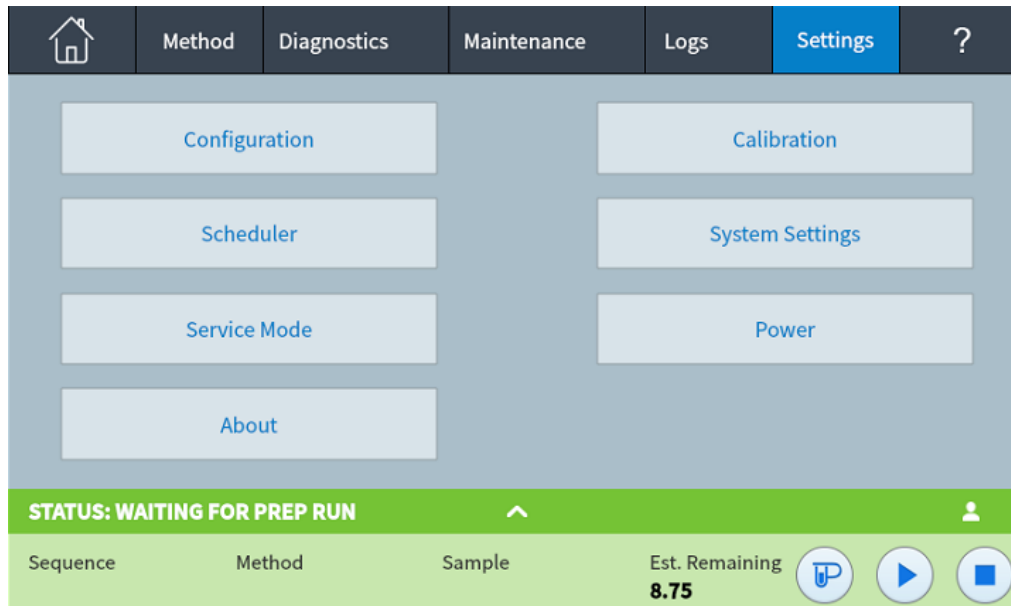

Figure 37 Settings view

- Press **Configuration** to access the GC configuration settings. (See [“Configuration”](#) on page 129.)
- Press **Scheduler** to access the GC Instrument Schedule settings. (See [“Resource Conservation”](#) on page 145.)
- Press **Service Mode** to access the service mode settings for the GC. (See [“Service Mode”](#) on page 107.)
- Press **About** to get information about this GC.
- Press **Calibration** to access the calibration functions. (See [“Calibration”](#) on page 112.)
- Press **System Settings** to access the system settings for the GC, including setting the network address, system date and time, touch screen settings, system setup information, and so on. (See [“System Settings”](#) on page 115.)
- Press **Power** to access the Power dialog box. (See [“Power Options”](#) on page 128.)

Service Mode

The Service Mode feature allows you to view the installed GC system component details. This includes serial numbers, firmware versions, voltages, currents, temperatures, and so on.

NOTE

Your GC must be connected to the Internet in order to check for, and install, available firmware updates.

To check your current firmware version and check for, and install, a version update:

- 1 Press **Settings** on the touch screen control ribbon. The Settings view appears. See [Figure 37](#) on page 106.
- 2 Press **Service Mode**. The Service Mode page appears. See [Figure 38](#).

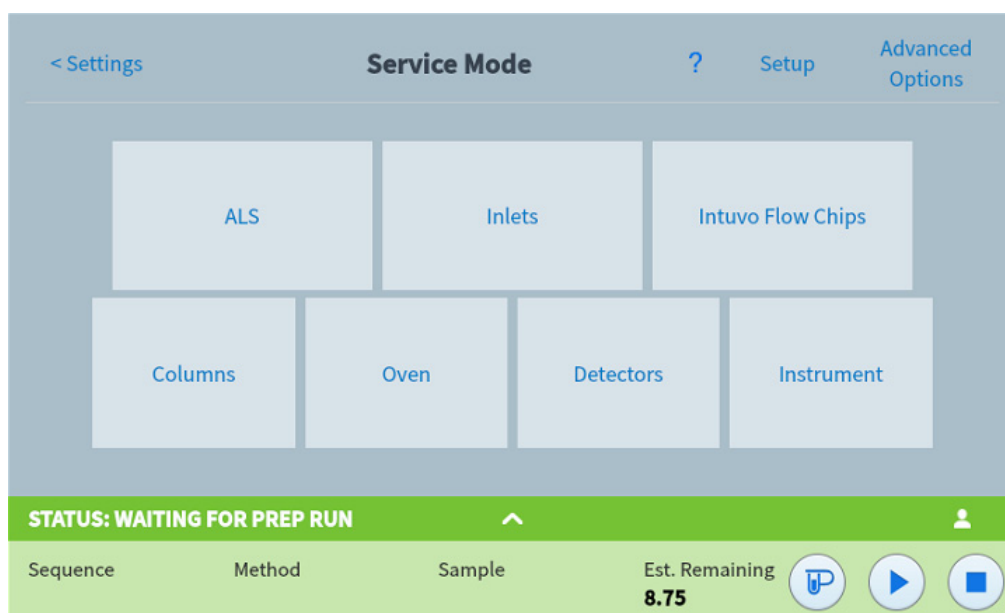
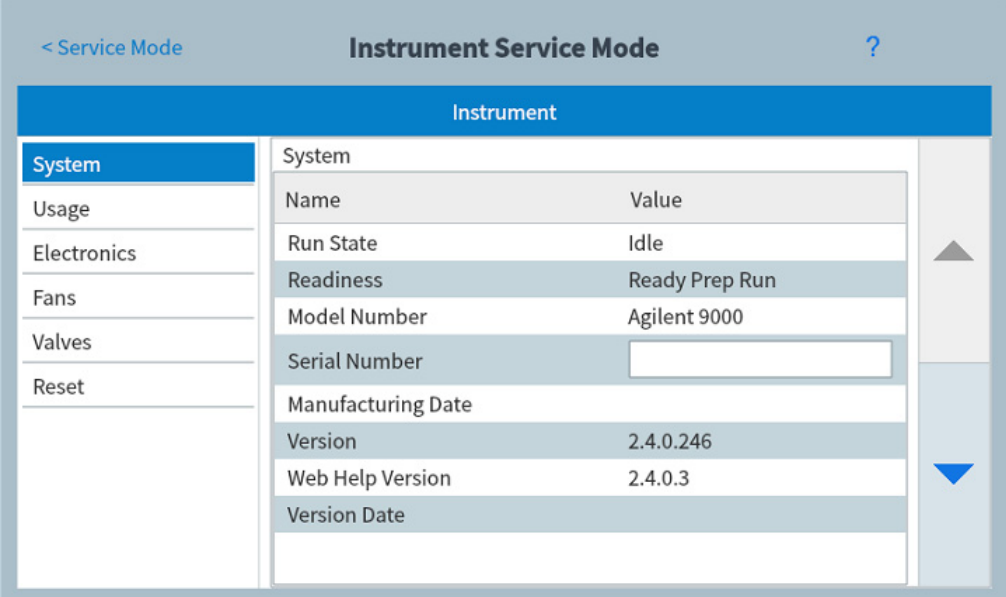

Figure 38 Service Mode page

NOTE

The **Advanced Features** link is for use by Agilent service personnel only.

- 3 Select the desired component type by pressing the corresponding button. The Service Mode page for the selected component appears. See [Figure 39](#).



The screenshot displays the 'Instrument Service Mode' page. At the top, there is a navigation bar with '< Service Mode' on the left, 'Instrument Service Mode' in the center, and a question mark '?' on the right. Below this is a blue header bar labeled 'Instrument'. On the left side, there is a vertical menu with buttons for 'System', 'Usage', 'Electronics', 'Fans', 'Valves', and 'Reset'. The 'System' button is currently selected. The main content area shows a table of system information:

Name	Value
Run State	Idle
Readiness	Ready Prep Run
Model Number	Agilent 9000
Serial Number	<input type="text"/>
Manufacturing Date	
Version	2.4.0.246
Web Help Version	2.4.0.3
Version Date	

On the right side of the table, there are two vertical arrows: an upward-pointing arrow above the table and a downward-pointing arrow below the table.

Figure 39 Instrument Service Mode page

- 4 Use the page selection buttons on the left side of the page to display related functional information.

Resetting system items

Certain items, such as configuration settings, UI defaults, and run data can be reset.

NOTE

System items cannot be reset from the browser interface. Use the GC touch screen to perform these functions.

Reset any item as needed. Clearing data or settings from the GC also clears this information from the Browser UI. **Changes are permanent and cannot be undone.**

- 1 From the System Settings page, press the **Reset** page selection button. The Reset page appears. See [Figure 40](#).

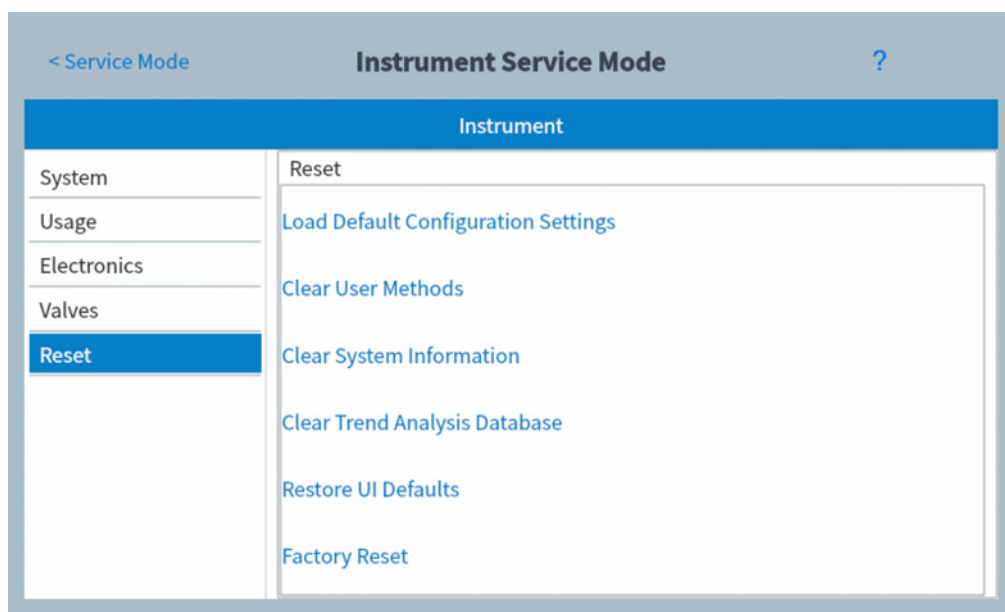

Figure 40 Reset page

- 2 Press the item to be cleared or reset. A confirmation dialog appears.

Load Default Configuration Settings: Resets all configuration settings to factory defaults (gas types, IP address, flow autozero, and similar).

Clear User Methods: Deletes all stored methods from the GC.

Clear System Information: Clears the Diagnostic, Maintenance, and EMF-related data and logs accessed from the Logs tab.

Clear Trend Analysis Database: Delete all data used for trend analysis. No data will be available for trend analysis until new data is collected.

Restore UI Defaults: Restores the touch screen to its factory defaults (brightness is set to 100%, the locale becomes English, the GC runs the system setup wizard on reboot and similar).

Factory Reset: Deletes all saved data, including run data, usage data, logs, configuration settings, browser interface sequences and methods, feature selection choices by a data system, and so forth, and sets the instrument to an unconfigured state.

- 3 Press **OK**. The dialog box closes. The selected items are cleared or reset, as applicable.

About This GC

The About feature allows you to view details about the GC.

The About screen lists the GC manufacturing date, serial number, firmware revision, and help and information revision.

To access the About function:

- 1 Press **Settings** on the touch screen control ribbon. The Settings view appears. See [Figure 37](#) on page 106.
- 2 Press **About**. The About page appears. See [Figure 41](#).

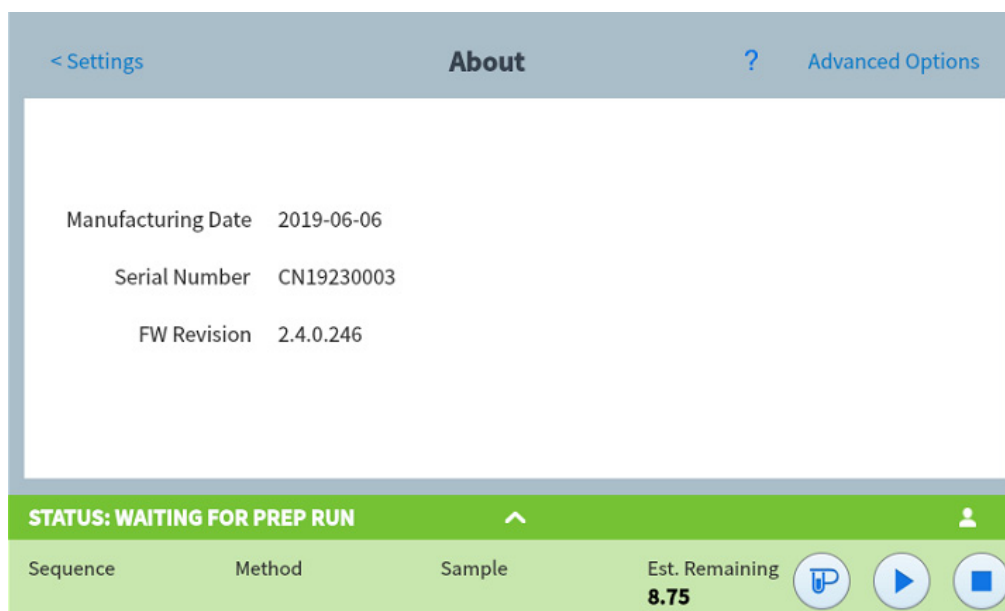

Figure 41 About page

- 3 Press **Close** on the About page to return to the Settings view.

Calibration

Calibration allows you to adjust the following items (when available):

- Inlets
- Oven
- Detectors

To access the Calibration function:

- 1 Press **Settings** on the touch screen control ribbon. The Settings view appears. See [Figure 37](#) on page 106.
- 2 Press **Calibration**. The Calibration page appears. See [Figure 42](#).

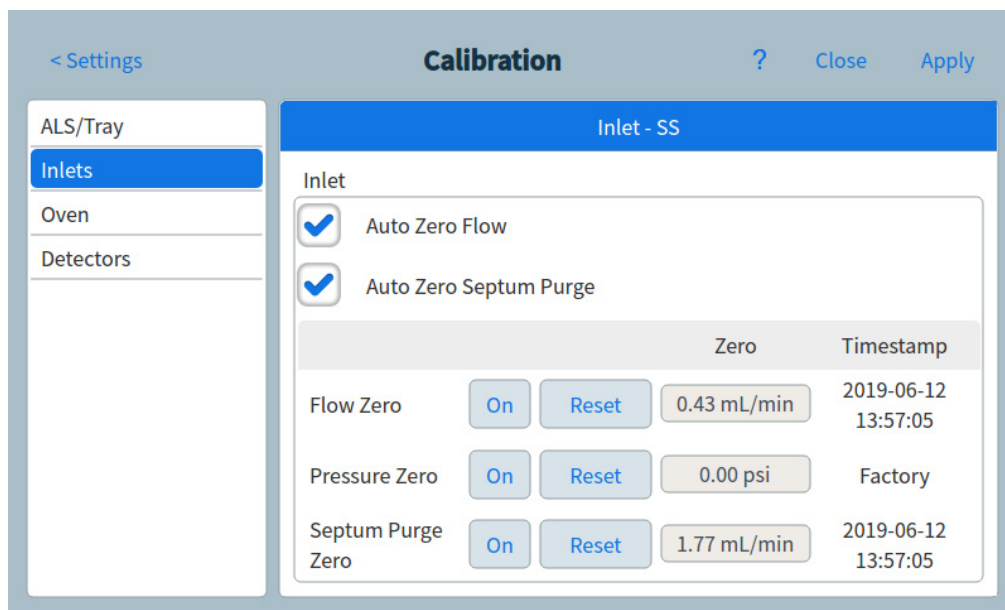

Figure 42 Calibration page

- 3 Use the page selection buttons on the left side of the page to display related functional information.
- 4 Make changes to calibration settings as desired. See [“Maintaining EPC calibration—inlets, detectors, PCM, and AUX”](#) on page 113, and [“To zero a specific flow or pressure sensor”](#) on page 114 or more information.
- 5 Press **Apply**. The entered changes are saved to the GC.

Maintaining EPC calibration—inlets, detectors, PCM, and AUX

The EPC gas control modules contain flow and/or pressure sensors that are calibrated at the factory. Sensitivity (slope of the curve) is quite stable, but zero offset requires periodic updating.

Flow sensors

The split/splitless and MMI inlet modules use flow sensors. If the **Auto flow zero** feature is selected, they are zeroed automatically after each run. This is the recommended setting. They can also be zeroed manually—see [“To zero a specific flow or pressure sensor”](#) on page 114.”

Pressure sensors

All EPC control modules use pressure sensors. They must be zeroed individually. There is no automatic zero for pressure sensors.

Auto Zero flow

A useful calibration option is **Auto Zero flow**. When selected, after the end of a run, the GC shuts down the flow of gases to an inlet, waits for the flow to drop to zero, measures and stores the flow sensor output, and turns the gas back on. This takes about two seconds. The zero offset is used to correct future flow measurements.

Auto zero septum purge

This is similar to **Auto zero flow**, but is for the septum purge flow.

Zero conditions

Flow sensors are zeroed with the carrier gas connected and flowing.

Pressure sensors are zeroed with the supply gas line disconnected from the gas control module.

Zero intervals

Table 6 Flow and Pressure Sensor Zero Intervals

Sensor type	Module type	Zero interval
Flow	All	Use Auto flow zero and/or Auto zero septum purge
Pressure	Inlets	
	Small capillary columns (id 0.32 mm or less)	Every 12 months
	Large capillary columns (id > 0.32 mm)	At 3 months, at 6 months, then every 12 months
	Auxiliary channels	Every 12 months
	Detector gases	Every 12 months

To zero a specific flow or pressure sensor

- 1 For **Flow sensors**. Verify that the gas is connected and flowing (turned on).
- 2 For **Pressure sensors**. Disconnect the gas supply line at the back of the GC. Turning it off is not adequate; the valve may leak.
- 3 Reconnect any gas line disconnected in the previous step and restore operating flows.

System Settings

System settings includes setting the network address, system date and time, touch screen theme, disk space and data settings, locale setting, system setup information, and status parameter settings.

To access system settings:

- 1 Press **Settings** on the touch screen control ribbon. The Settings view appears. See [Figure 37](#) on page 106.
- 2 Press **System Settings**. The System Settings page appears. See [Figure 43](#).

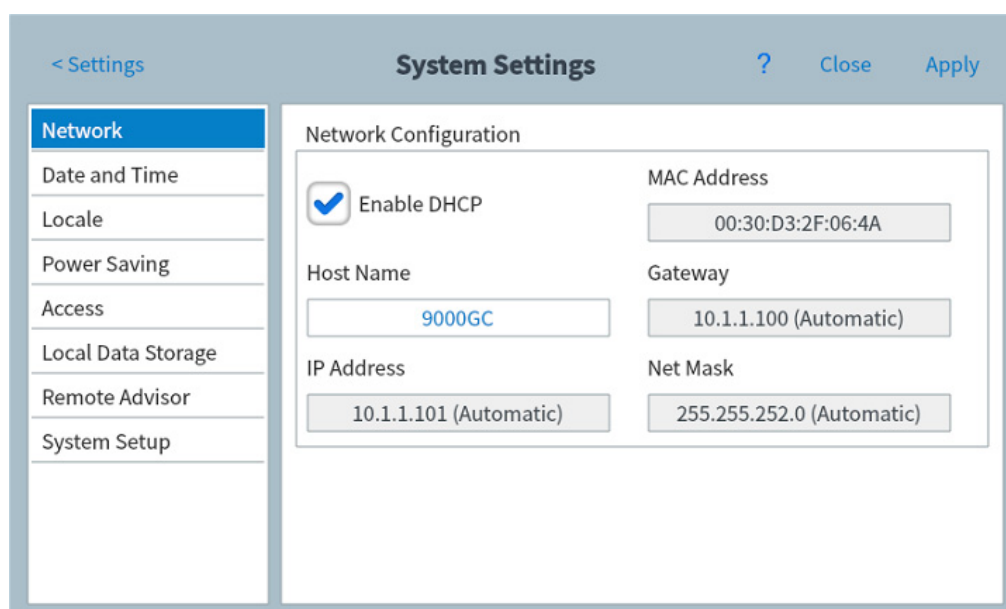

Figure 43 System Settings page

- 3 Use the page selection buttons on the left side of the page to display related functional information.
- 4 Press **Apply** to apply any changes made to the GC.

Configuring the IP address for the GC

For network (LAN) operation, the GC needs an IP address. It can get this from a DHCP server, or it can be entered directly from the touch screen. In either case, see your LAN administrator for appropriate settings.

To use a DHCP server

- 1 From the System Settings page, press the **Network** page selection button. The Network Configuration page appears. See [Figure 44](#).

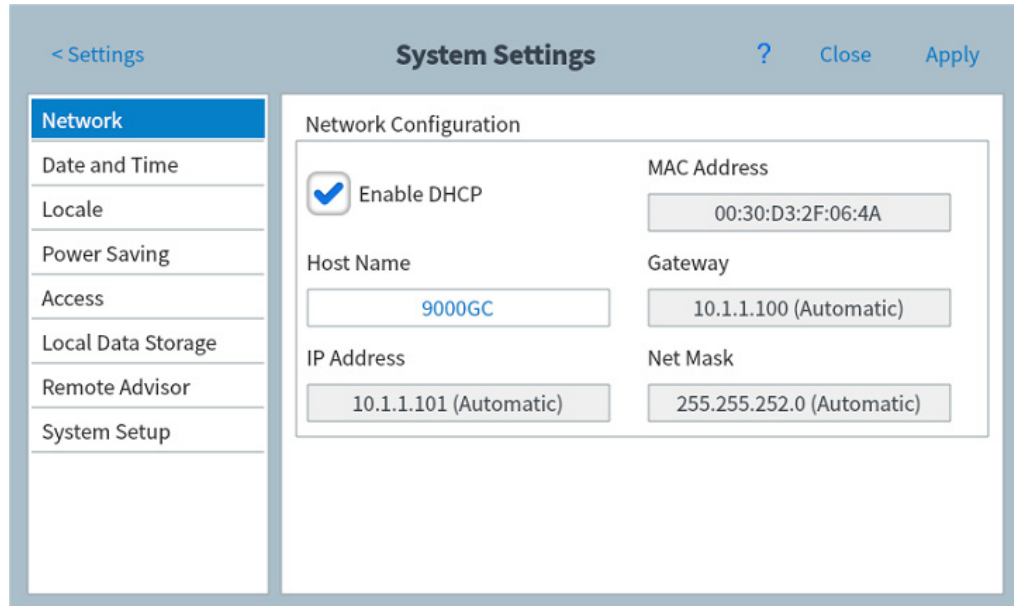

Figure 44 Network Configuration page

- 2 Select **Enable DHCP**.
- 3 Press **Apply**.
- 4 When prompted, restart the GC. (See [“Power Options”](#) on page 128.)

To set the LAN address at the touch screen

- 1 From the System Settings page, press the **Network** page selection button.
- 2 If **Enable DHCP** is selected:
 - a Deselect **Enable DHCP**.
 - b When prompted, restart the GC. (See [“Power Options”](#) on page 128.)
- 3 Return to the System Settings page, and then scroll to the Network Configuration area.
- 4 Enter the **Host Name** in the corresponding field.
- 5 Enter the **Gateway** number in the corresponding field.
- 6 Enter the **IP Address** in the corresponding field.

- 7 Enter the subnet mask in the **Net Mask** field.
- 8 Press **Apply**.
- 9 When prompted, restart the GC. (See “Power Options” on page 128.)

To set system date and time

- 1 From the System Settings page, press the **Date and Time** page selection button. The Date and Time page appears. See Figure 45.

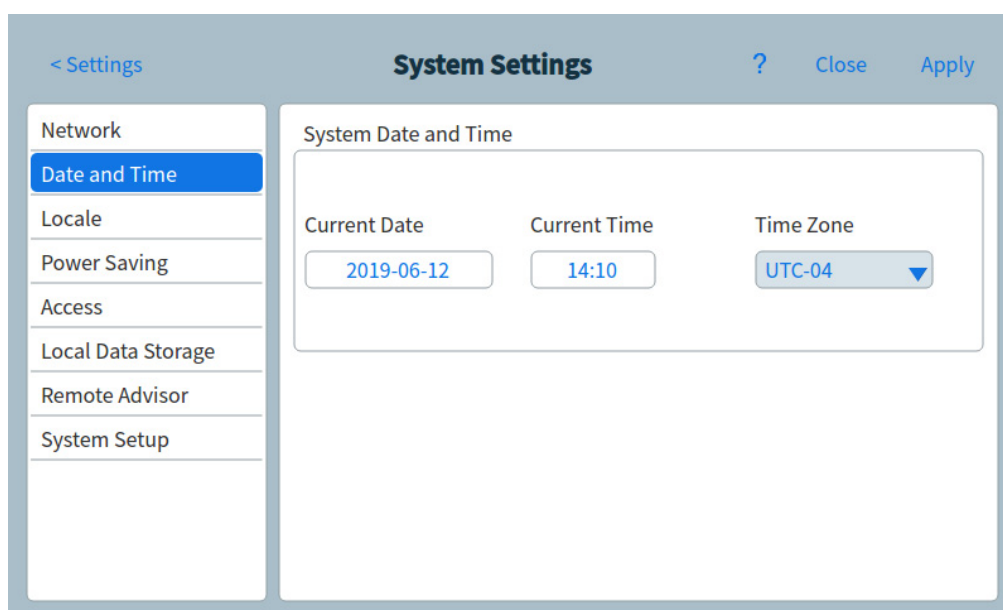

Figure 45 System Settings page

- 2 Press the **Current Date** field. A touch keypad appears.
- 3 Enter the current date.
- 4 Press **Apply**. The touch keypad closes. The selected date is displayed in the field.
- 5 Press the **Current Time** field. A touch keypad appears.
- 6 Enter the current time.
- 7 Press **Apply**. The touch keypad closes. The selected time is displayed in the field.
- 8 Choose the appropriate **Time Zone** from the corresponding drop-down list box.
- 9 Press **Apply**. The GC saves all of the changes made.

To change the system locale

- 1 From the System Settings page, press the **Locale** page selection button. The Locale Settings page appears. See [Figure 46](#).

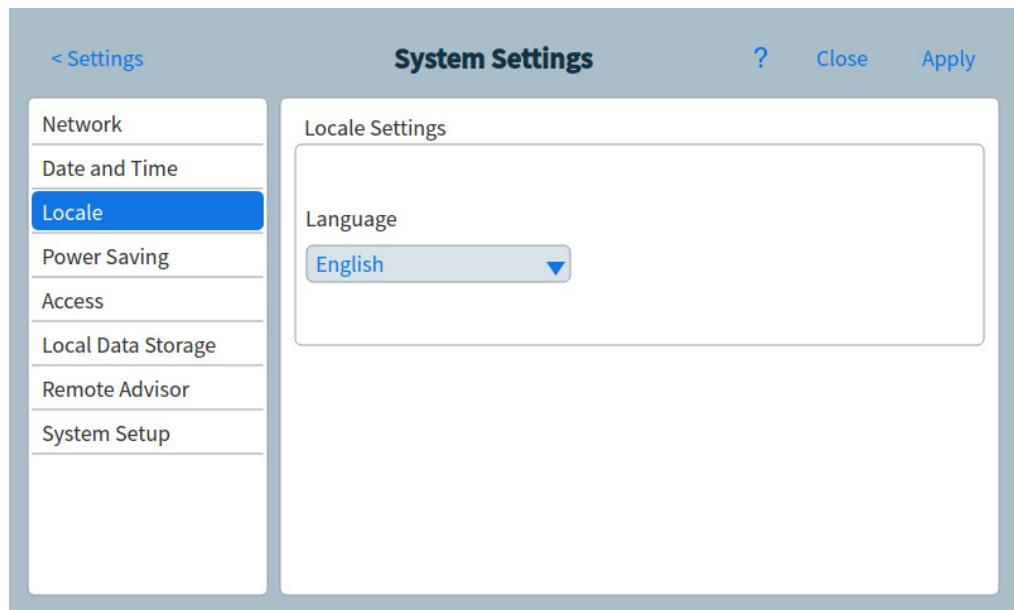

Figure 46 Locale Settings page

- 2 Choose the desired **Language** from the corresponding drop-down list box.
- 3 Press **Apply**. The GC saves the change made. The system is changed to the selected locale. This may take a few moments.

To set system power saving features

- 1 From the System Settings page, press the **Power Saving** page selection button. The Power Saving page appears. See [Figure 47](#).

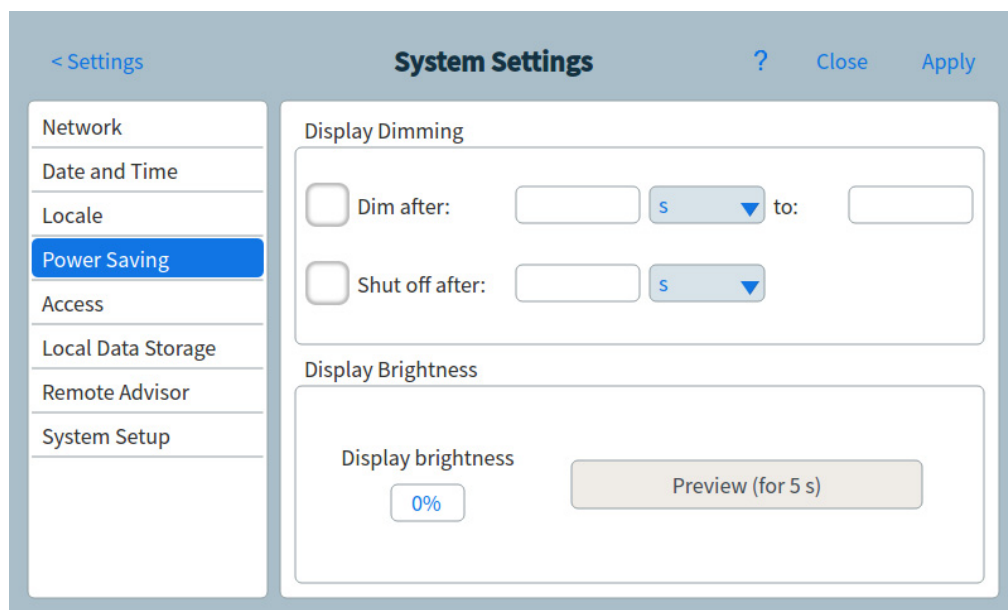

Figure 47 Power Saving page

- 2 To enable display dimming:
 - a Select the **Dim display after:** check box. The corresponding data entry fields and drop-down list box are enabled.
 - b Use the data entry fields and drop-down list box to set the desired values.
- 3 To enable display shut off:
 - a Select the **Shut off display after:** check box. The corresponding data entry field and drop-down list box are enabled.
 - b Use the data entry field and drop-down list box to set the desired values.

- 4 To change the default display brightness:
 - a Press the **Display brightness** field. A touch keypad appears.
 - b Enter the desired brightness value.
 - c Press **Apply**. The touch keypad closes. The selected value is displayed in the **Display brightness** field.
 - d Press **Preview (for 5 seconds)**. The screen brightness adjusts to the specified value for five seconds.

NOTE

The dim display value must be less than the display brightness value.
The display brightness value must be greater than 0.

- 5 Press **Apply**. The GC saves all of the changes made.

To access stored run data

If using the Browser Interface to perform runs and collect data, the GC stores the result data internally. To access that data:

- 1 From the **System Settings** page, select **Access**. Note the displayed PIN.
- 2 Select **Local Data Storage**. Note the path to the GC share.
- 3 On your PC, map a network drive to the GC share. When prompted, connect using the credentials:

user: results

password: the PIN (default: 0000).

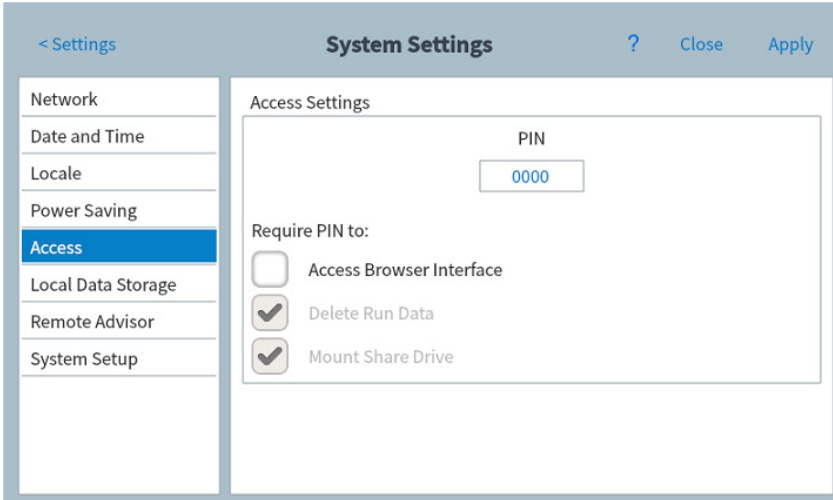

The screenshot shows the 'System Settings' interface. On the left is a navigation menu with options: Network, Date and Time, Locale, Power Saving, Access (highlighted), Local Data Storage, Remote Advisor, and System Setup. The main content area is titled 'Access Settings' and contains a 'PIN' field with the value '0000'. Below this is a section 'Require PIN to:' with three checkboxes: 'Access Browser Interface' (unchecked), 'Delete Run Data' (checked), and 'Mount Share Drive' (checked). At the top right of the settings window are buttons for '?', 'Close', and 'Apply'.

To control Browser Interface access

The GC is set so that a four-digit PIN must be used to perform the following actions for your GC:

- Delete run data.
- Mount a share drive.

By default, the PIN is set to 0000. Additionally, you may choose to require the PIN to access the Browser Interface. To set the PIN:

- 1 From the **System Settings** page, select **Access**.
- 2 Select the four-digit PIN to input a new PIN.
- 3 If desired, select the checkbox next to Access Browser Interface to require the PIN for all browser interface connections.

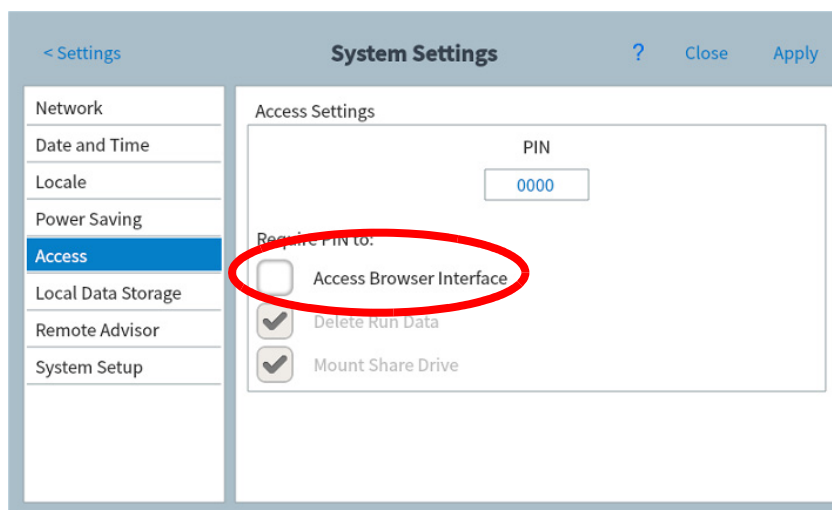

To change the remote advisor settings

Remote advisor is a monitoring service designed to identify and react to problems with the GC. The GC constantly monitors its own health status and generates reporting information which is forwarded to Agilent.

- 1 From the System Settings page, press the **Remote Advisor** page selection button. The Remote Advisor page appears. See [Figure 48](#).

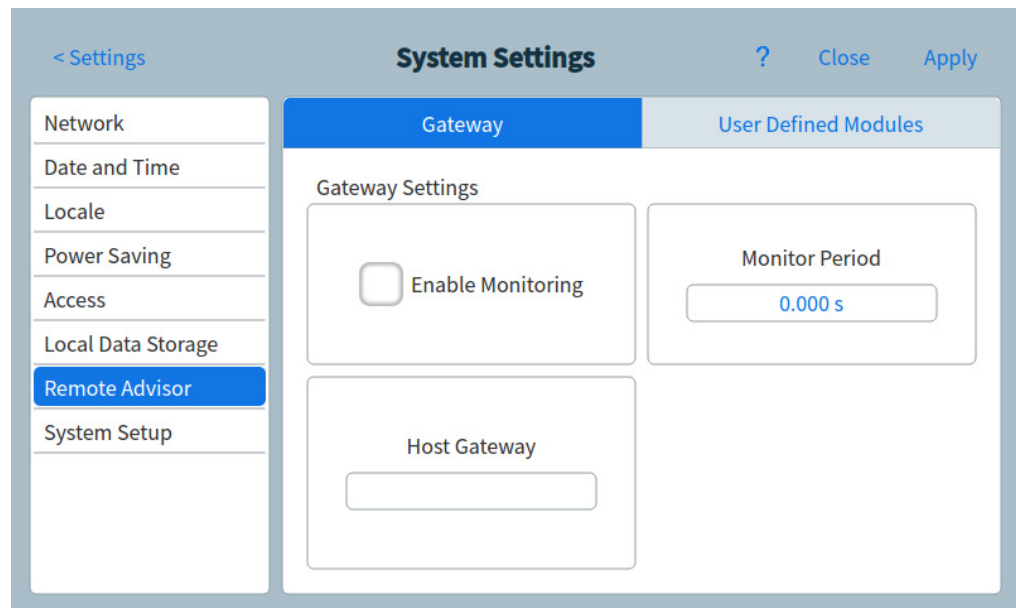

Figure 48 Remote Advisor page

- 2 Enter the IP address of the Remote Advisor service in the **Host Gateway** field.
- 3 Enter the polling frequency for data collection on the GC in the **Monitor Period** field. This determines the frequency at which the GC collects data and sends its health report details to Agilent. This value is in seconds.
- 4 When there are additional devices installed on the GC (such as a purge and trap device) which are covered by the Remote Advisor agreement, these devices are identified on the **User**

Defined Modules tab. To identify these types of devices, do the following:

- a Press the **User Defined Modules** tab. The **User Defined Modules** page appears. See [Figure 49](#).

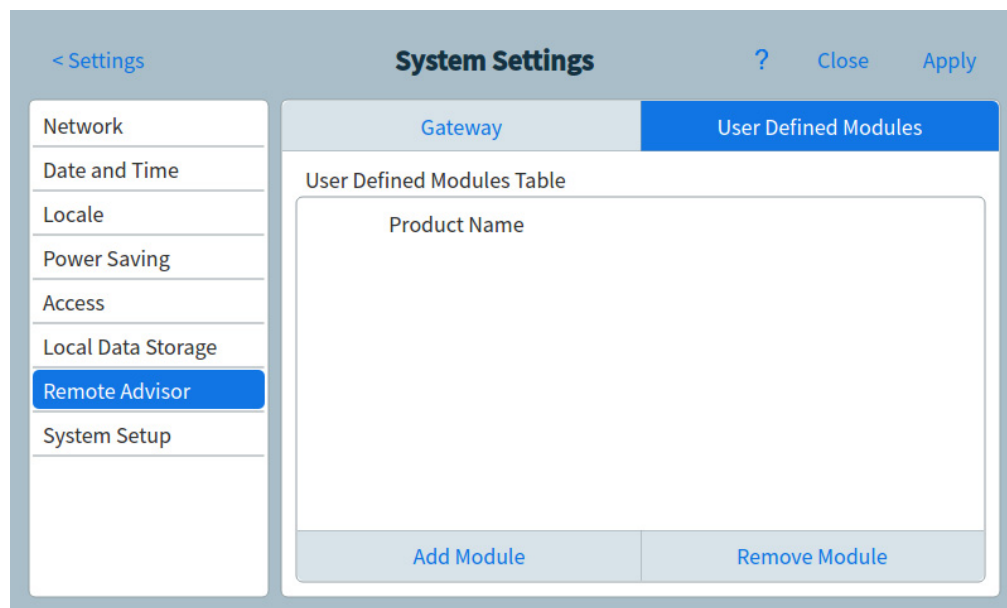

Figure 49 Remote Advisor page - User Defined Modules tab

- b Press **Add Module**. A Product Name entry line appears. See [Figure 50](#).

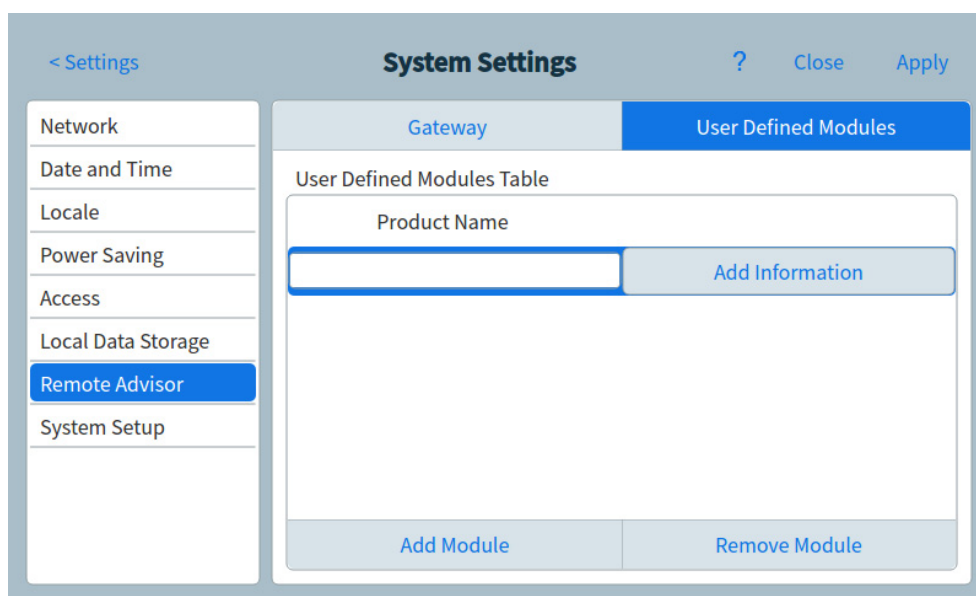

Figure 50 Remote Advisor page - Add Information

- c Enter the Product Name in the corresponding field.
- d Press **Add Information**. The Hardware Info dialog box appears. See [Figure 51](#).

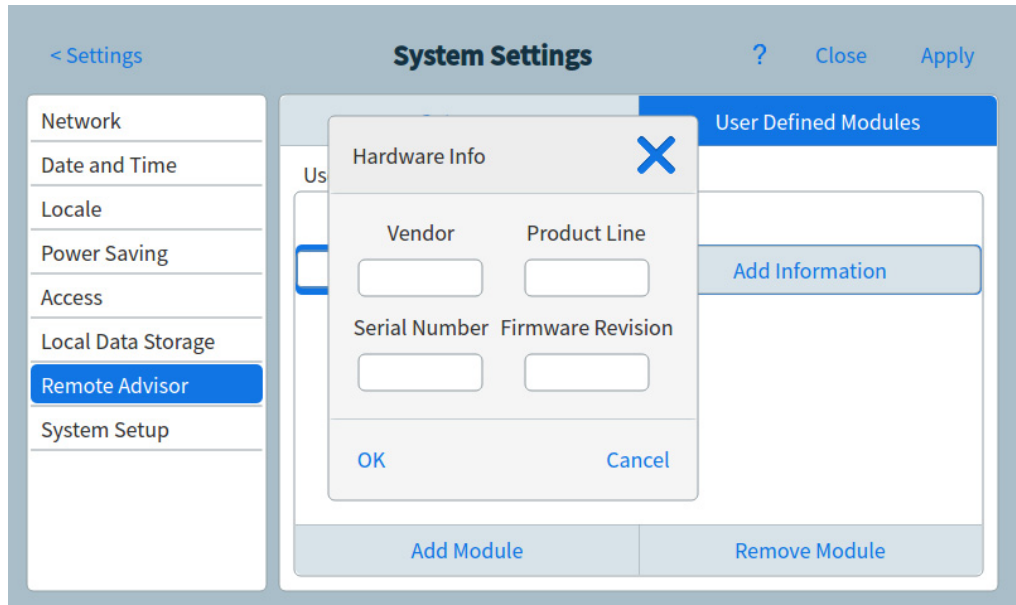

Figure 51 Remote Advisor page - Hardware Info dialog box

- e Enter details for the device in the appropriate fields.
 - f Press **OK**. The dialog box closes.
 - g Repeat [step b](#) through [step f](#) for any additional devices to be added to Remote Advisor.
- 5 Press **Apply**. The GC saves all of the changes made.

To run the system setup routine

- 1 From the System Settings page, press the **System Setup** page selection button. The System Setup page appears. See [Figure 43](#).

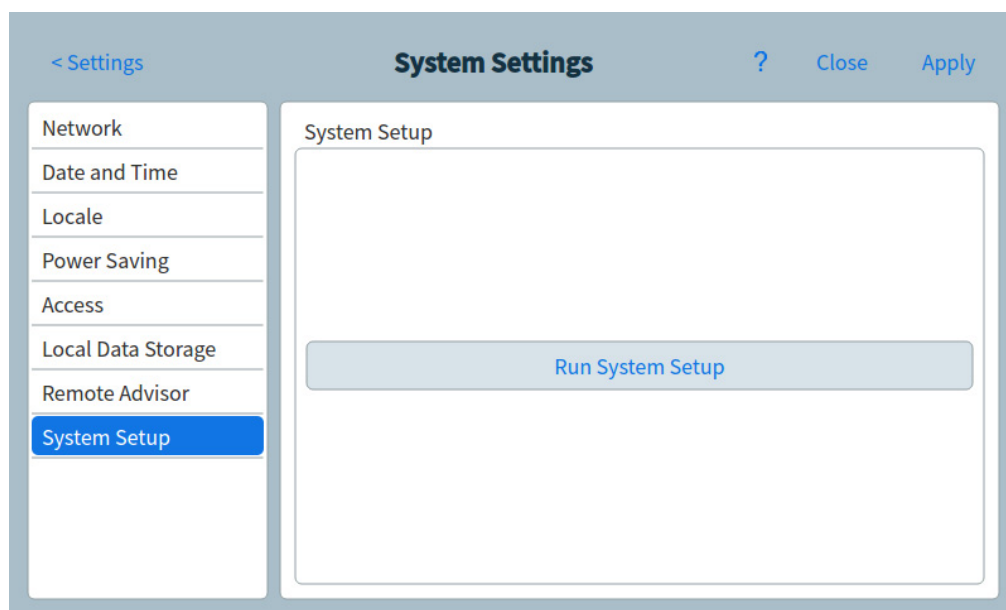

Figure 52 System Setup page

- 2 Press **Run System Setup**. A set of demonstration slides is displayed on the touch screen. These slides illustrate the primary steps for setting up your GC for use. Certain slides allow you to enter setup information which is available elsewhere in the GC user interface. These items include:
 - System data and time (see [“To set system date and time”](#) on page 117)
 - Displayed pressure units (see [“Miscellaneous Settings”](#) on page 143)
 - System network address (see [“Configuring the IP address for the GC”](#) on page 115)
 - Inlet and detector gas types (see [“Inlet Configuration”](#) on page 135)

Additionally, you are asked whether the GC is connected to a data system, and prompted to perform checkout. (See [“Chromatographic Checkout”](#) on page 157.)

- 3 Follow the instructions on the touch screen to view the demonstration.

Tools (Browser Interface)

The Tools page allows you to perform column compensation runs for the installed columns on the GC. See [Figure 53](#).

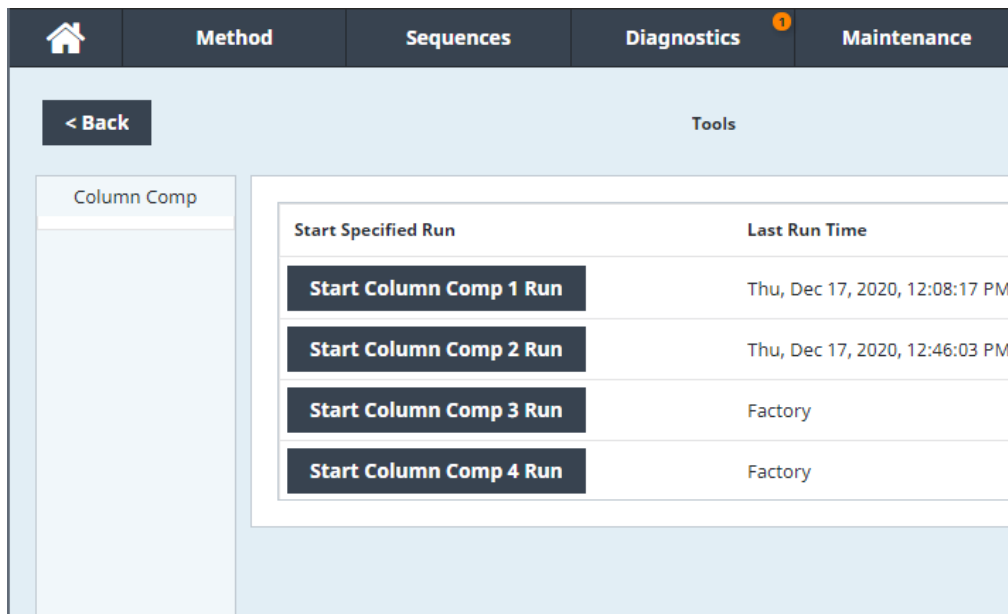

Figure 53 Tools page

In temperature programmed analysis, bleed from the column increases as the oven temperature rises. This causes a rising baseline which makes peak detection and integration more difficult. Column compensation corrects for this baseline rise.

A column compensation run is made with no sample injected. The GC collects an array of data points from any installed detectors. If a detector is not installed or is turned off, that part of the array is filled with zeros.

Each array defines a set of curves, one for each detector, that can be subtracted from the real run to produce a flat baseline.

When a connected data system is used, the raw signal, and the column compensation data, is output to the data system so that a compensated, and uncompensated, signal are available for analysis.

Performing a Column Compensation Run

All conditions must be identical in the column compensation run and the real run. The same detector and column must be used, operating under the same temperature and gas flow conditions.

Up to four column compensation runs can be made. The GC retains the results of these runs for later use.

Any column compensation run can then be used to compensate a rising baseline during a run.

- 1 Connect to the GC using the browser interface, and navigate to **Settings > Tools**.
- 2 With the Tools page displayed (see [Figure 53](#) on page 126), select the desired **Column Compensation** in the **Start Specified Run** column. The GC performs the column compensation run. No injection occurs as a part of this run.
- 3 Set the detector to **Subtract from Signal: Column compensation Curve #x** (where **x** is the number of the column compensation run).
- 4 Run the method. The results use the column compensation run data to compensate for baseline changes in the column.

This feature can be disabled by a connected data system. See [“Touch Screen Functionality When the GC Is Controlled by an Agilent Data System”](#) on page 54

Power Options

The Power Options dialog box allows you to shut down or restart the GC from the touch screen.

To shut down or restart the GC:

- 1 Press **Settings** on the touch screen control ribbon. The Settings view appears. See [Figure 37](#) on page 106.
- 2 Press **Power**. The Power Options dialog box appears.

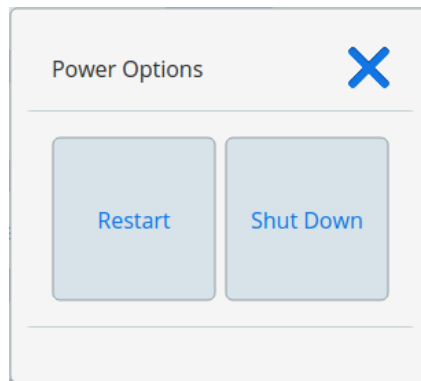
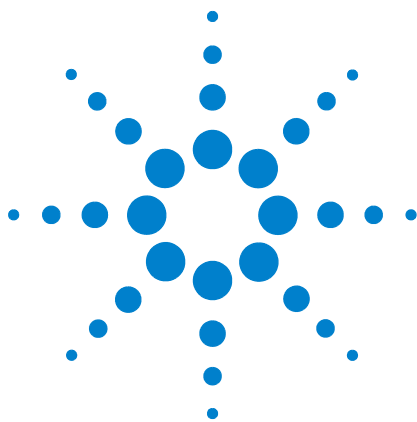

Figure 54 Power Options dialog box

- 3 To restart the GC, press **Restart**. The GC restarts.
- 4 To shut down the GC, press **Shut Down**. The GC shuts down.



9 Configuration

About Configuration	130
Making Configuration Changes	131
Valve Configuration	133
To configure valves	133
Inlet Configuration	135
To configure the Inlet Gas type	135
Shutdown behavior	137
Detector 1/Detector 2 Configuration	138
To configure the makeup/reference gas	138
MSD and Headspace Configuration	140
MSD Configuration	140
Headspace Sampler Configuration (7697)	141
Miscellaneous Settings	143

About Configuration

A device's configuration properties are constant for an instrument hardware setup, unlike method settings which can change from sample run to sample run. Two example configuration settings are the gas type flowing through a pneumatic device and the operation temperature limit of a device.

Making Configuration Changes

To change the setting configuration properties for a device:

- 1 Press **Settings** on the touch screen control ribbon. The Settings view appears. See [Figure 55](#).

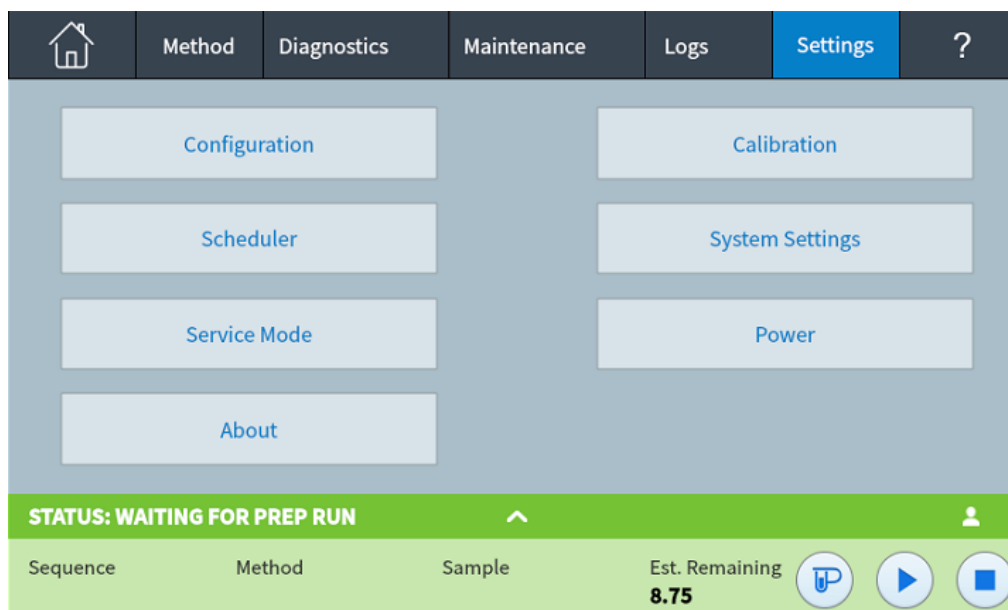

Figure 55 Settings view

- 2 Press **Configuration**. The Configuration page appears. See [Figure 56](#).

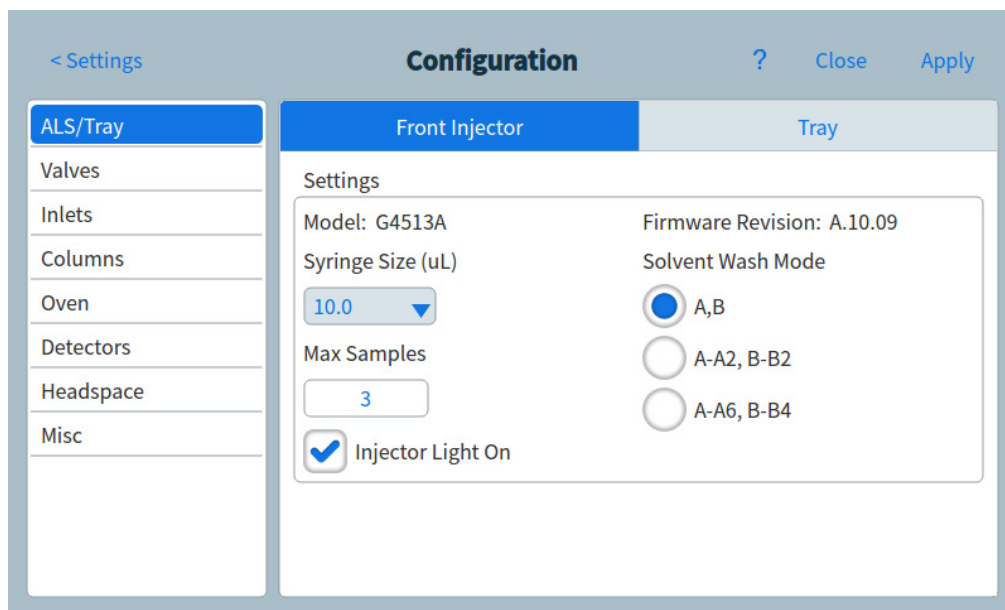

Figure 56 Configuration page

- 3 Press the desired device type from the list on the left side of the screen. The properties for the selected device type appear on the right side of the screen.
- 4 Scroll to the device setting and change the property. This can involve making a selection from a list, or entering a numeric value.
- 5 When all required changes have been made, press **Apply**. The entered changes are saved to the GC.

Valve Configuration

Valve configuration provides the ability to specify valve types, loop volumes, step times, and BCD inversion settings. BCD inversion allows for changing the BCD input (1's become 0's and 0's become 1's). This accommodates coding convention differences between manufacturers.

Valves are numbered 1, 5, 6, 7, and 8. There are no other numbered valve positions in the GC.

Note that the Valves page appears regardless of whether any valves are currently installed in the GC.

To configure valves

- 1 Press **Settings** on the touch screen control ribbon. The Settings view appears. See [Figure 55](#) on page 131.
- 2 Press **Configuration**. The Configuration page appears. See [Figure 56](#) on page 132.
- 3 Press the **Valves** device type from the list on the left side of the screen. The properties for the selected device type appear on the right side of the screen. See [Figure 57](#).

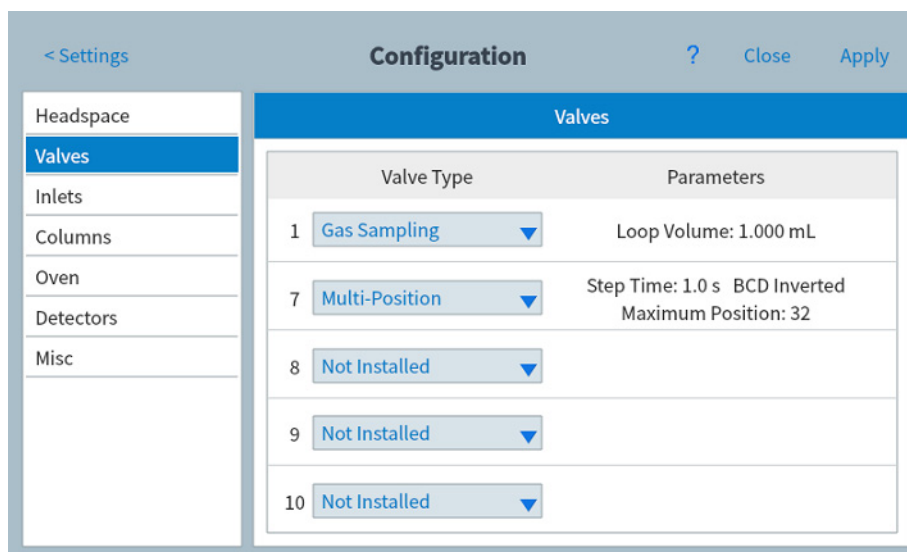

Figure 57 Valves page

- 4 For each installed valve, select the valve type from the drop-down list.

5 Tap the parameter you need to edit. A dialog opens.

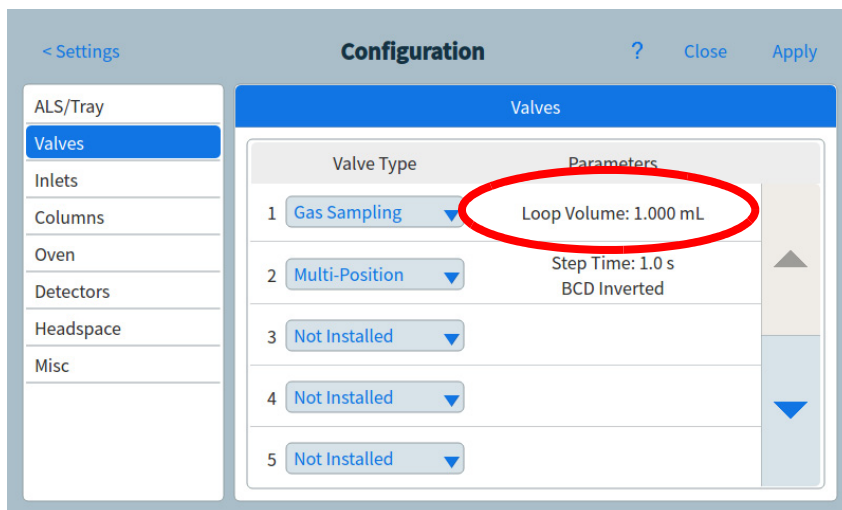

Figure 58 Settings Configuration Dialog

- 6 Enter your value for the parameter.
- 7 Close the dialog to apply the setting.
- 8 Tap **Apply**.

Inlet Configuration

To configure the Inlet Gas type

The GC needs to know what carrier gas is being used. To change the carrier gas type:

- 1 Press **Settings** on the touch screen control ribbon. The Settings view appears. See [Figure 55](#) on page 131.
- 2 Press **Configuration**. The Configuration page appears. See [Figure 56](#) on page 132.
- 3 Press the **Inlets** device type from the list on the left side of the screen. The properties for the selected device type appear on the right side of the screen. See [Figure 59](#).

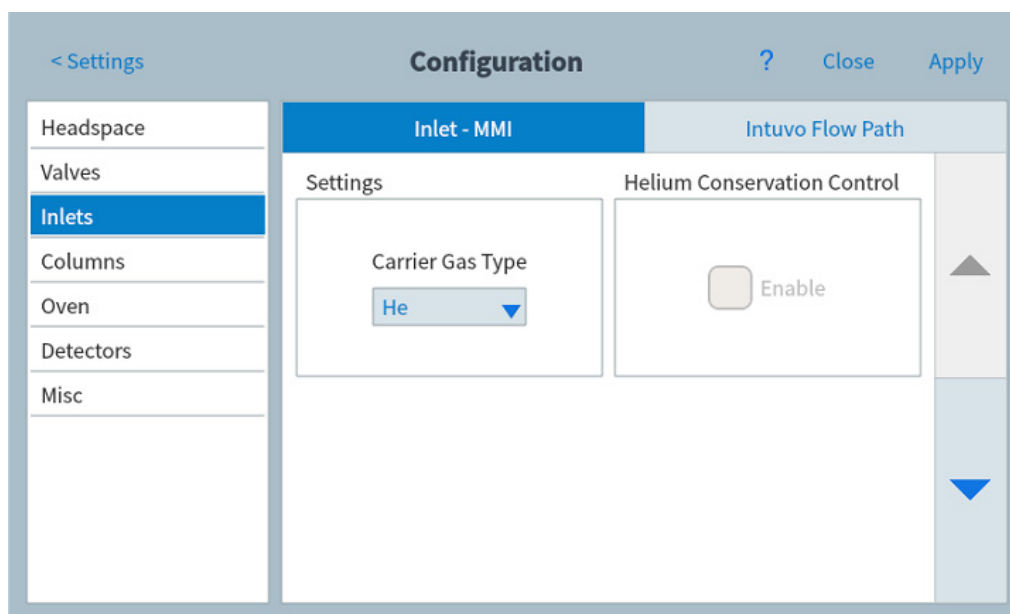

Figure 59 Inlets page

- 4 Select the desired gas type from the **Carrier Gas Type** drop-down list box.
- 5 If using an MMI inlet, the GC automatically detects the cryo coolant type.

If **Compressed air** is the Cooling type, air coolant is used to cool the inlet regardless of the **Use cryo temperature** setpoint during the cooling cycle. If the inlet reaches setpoint, the air coolant is turned off and stays off for the duration of the cooling cycle.

Several other parameters appear. Set them as described below.

- Cryo enables cryogenic cooling of the inlet at the specified **Use cryo temperature** setpoint. Deselecting this option disables cooling. If **N2 cryo** or **C02 cryo** is selected as the Cryo type, this setpoint determines the temperature below which cryogenic cooling is used continuously to hold the inlet at setpoint. Set the **Use cryo temperature** equal to or higher than the inlet setpoint to cool the inlet and hold the setpoint until the inlet temperature program exceeds the **Use cryo temperature**. If the **Use cryo temperature** is less than the inlet setpoint, cryogen will cool the inlet to the initial setpoint and turn off.
 - The **Cryo timeout** parameter is available with **N2 cryo** and **C02 cryo** Cryo types. Use this setting to conserve cryogenic fluid. If selected, the instrument shuts down the inlet and cryogenic cooling when no run starts in the number of minutes specified. The setpoint range is 2 to 120 minutes (default 30 minutes). Turning cryo timeout off disables this feature. We recommend cryo timeout enabling to conserve coolant at the end of a sequence or if automation fails. A Post Sequence method could also be used.
 - The **Cryo fault** parameter is available with **N2 cryo** and **C02 cryo** Cryo types. Shuts down the inlet temperature if it does not reach setpoint in 16 minutes of continuous cryo operation. Note that this is the time to reach the setpoint, not the time to stabilize and become ready at the setpoint.
- 6 Press the **Intuvo Flow Path** tab. The Intuvo Flow Path page appears. See [Figure 60](#).

< Settings **Configuration** ? Close Save

Inlet 1 - SSL **Intuvo Flow Path**

A Smart Key is present. Some fields may be locked.

Manufacturer	Date Manufactured
AGILENT	2016-02-25
Batch Number	Part Number
DB123456	G4581-60033
Max Temperature	Min Temperature
450 °C	0 °C

ALS
Valves
Inlets
Columns
Detectors
Analog Out
Headspace
Misc

Figure 60 Intuvo Flow Path page

- 7 Use the fields on this page to modify the flow path settings as required.
- 8 Press **Apply**. The entered changes are saved to the GC.

Shutdown behavior

Both Cryo timeout and Cryo fault can cause cryo shutdown. If this happens, the inlet heater is turned off and the cryo valve closes. The GC beeps and displays a message.

The inlet heater is monitored to avoid overheating. If the heater remains on at full power for more than 2 minutes, the heater is shut down. The GC beeps and displays a message.

To recover from either condition, turn the GC off, then on, or enter a new setpoint.

Detector 1/Detector 2 Configuration

To configure the makeup/reference gas

The makeup gas line of your detector parameter list changes depending on your instrument configuration.

If you have an inlet with the column not defined, the makeup flow is constant. If you are operating with column defined, you have a choice of two makeup gas modes. To set the makeup gas for a detector:

- 1 Press **Settings** on the touch screen control ribbon. The Settings view appears. See [Figure 55](#) on page 131.
- 2 Press **Configuration**. The Configuration page appears. See [Figure 56](#) on page 132.
- 3 Press the **Detectors** device type from the list on the left side of the screen. The properties for the selected device type appear on the right side of the screen. See [Figure 61](#).

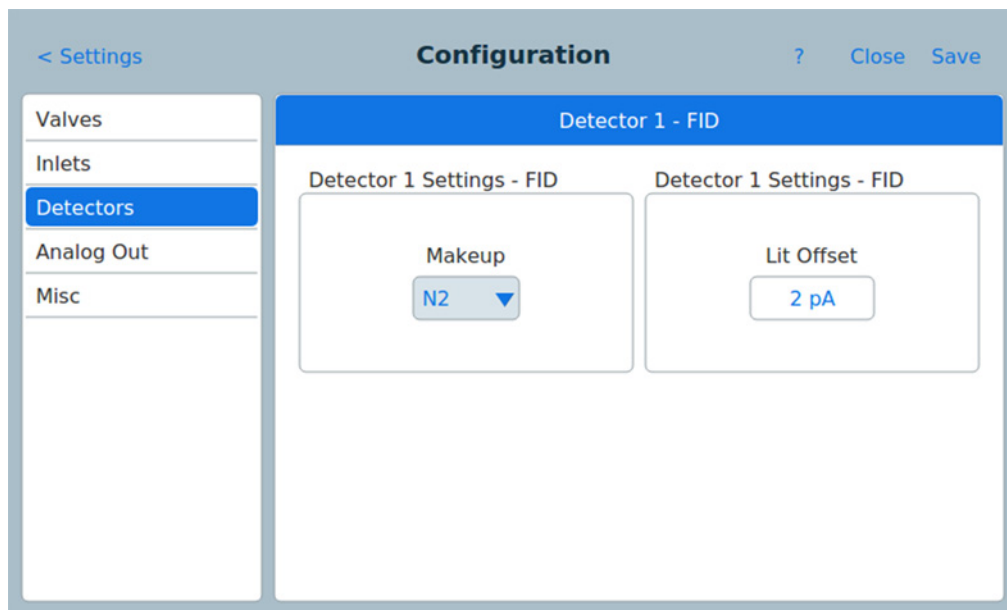

Figure 61 Detectors page

- 4 Use the **Makeup** drop-down list box list to choose the desired gas type for the detector.
- 5 The GC monitors the difference between the detector output with the flame lit and the output when the flame is not lit. If this difference falls below the setpoint, the GC assumes that the flame has gone out and tries to reignite it.

If set too high, the lit detector baseline output can be below the **Lit Offset** setpoint, causing the GC to erroneously try to reignite the flame.

Use the **Lit Offset** text field to specify the offset.

- 6 Press **Apply**. The entered changes are saved to the GC.

MSD and Headspace Configuration

MSD Configuration

The method for configuring a connected MSD varies based on the model of MSD being used.

5977B HES GC/MSD

The 5977B connects to the GC via an LVDS cable to one of the ELVDS communication ports on the rear of the GC. Because of this, the GC treats the MSD as a detector. No communication configuration is necessary.

To change the 5977B settings:

- 1 Press **Settings** on the touch screen control ribbon. The Settings view appears. See [Figure 55](#) on page 131.
- 2 Press **Configuration**. The Configuration page appears. See [Figure 56](#) on page 132.
- 3 Press the **Detectors** device type from the list on the left side of the page. The properties for the selected device type appear on the right side of the page. See [Figure 62](#).

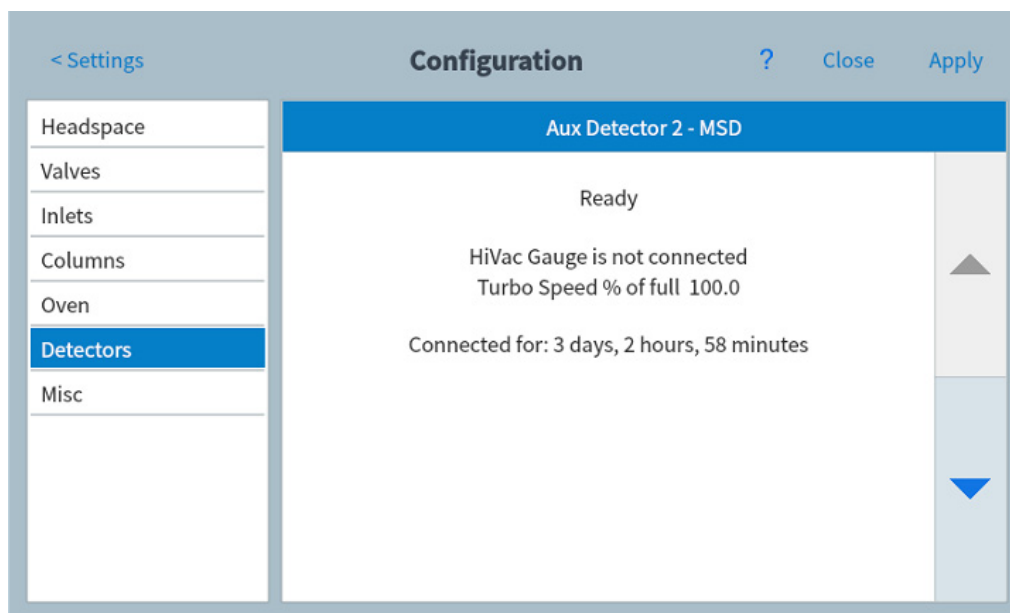

Figure 62 Detector MSD settings page

- 4 Use this page to enter details for, and control, the MSD. This includes temperature setpoints, communication settings,

MSD information and initiating venting, pump downs, and reboots.

- 5 Press **Apply**. The entered changes are saved to the GC.

5977A, 7000C, 7000D, 7010A, 7010B GC/MS

These devices connect to the GC via an LAN cable either to the LAN cable on the rear of the GC or to the GC via the laboratory network. To change the settings:

- 1 Press **Settings** on the touch screen control ribbon. The Settings view appears. See [Figure 55](#) on page 131.
- 2 Press **Configuration**. The Configuration page appears. See [Figure 56](#) on page 132.
- 3 Press the **Detectors** device type from the list on the left side of the page. The properties for the selected device type appear on the right side of the page. See [Figure 62](#) on page 140.
- 4 Use this page to enter details for, and control, the MSD. This includes temperature setpoints, communication settings, MSD information and initiating venting, pump downs, and reboots.
- 5 Press **Apply**. The entered changes are saved to the GC.

Headspace Sampler Configuration (7697)

The 7697A headspace sampler is supported by the GC. The headspace sampler connects to the GC via an LAN cable either to the LAN cable on the rear of the GC or to the GC via the laboratory network. To change the settings:

- 1 Press **Settings** on the touch screen control ribbon. The Settings view appears. See [Figure 55](#) on page 131.
- 2 Press **Configuration**. The Configuration page appears. See [Figure 56](#) on page 132.
- 3 Press the **Headspace** device type from the list on the left side of the page. The properties for the selected device type appear on the right side of the page. See [Figure 63](#).

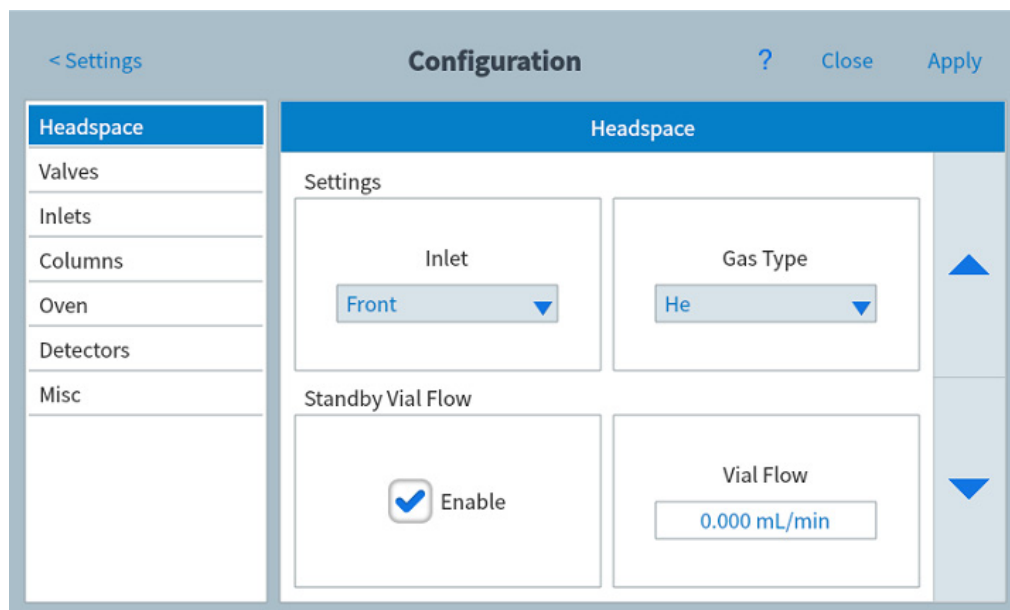

Figure 63 Headspace settings page

- 4 Use this page to enter details for, and control, the headspace sampler.
- 5 Press **Apply**. The entered changes are saved to the GC.

Headspace Sampler Configuration (8697)

The GC considers the Agilent 8697 headspace sampler to be an integrated part. Once installed, no further setup is needed for communication. To configure the headspace sampler, go to **Settings > Configuration > Headspace**. See the 8697 documentation for details.

Miscellaneous Settings

The GC provides two miscellaneous settings.

- Whether to allow columns without SmartID keys to be used.
- The pressure units displayed by the GC

To change the miscellaneous settings:

- 1 Press **Settings** on the touch screen control ribbon. The Settings view appears. See [Figure 55](#) on page 131.
- 2 Press **Configuration**. The Configuration page appears. See [Figure 56](#) on page 132.
- 3 Press the **Misc** device type from the list on the left side of the page. The properties for the selected device type appear on the right side of the page. See [Figure 64](#).

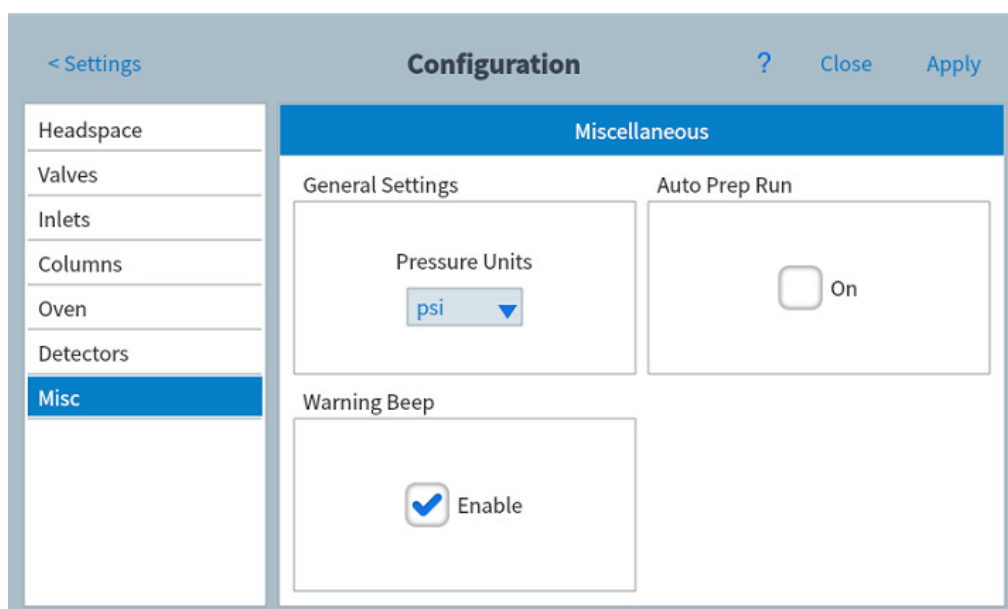
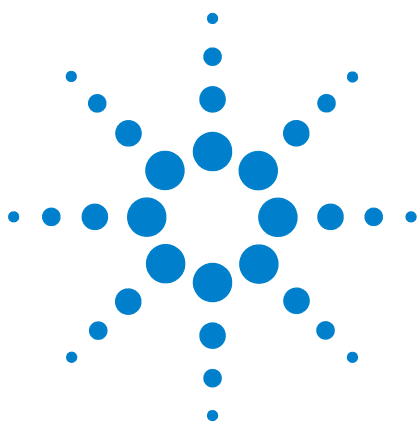

Figure 64 Miscellaneous settings page

- 4 Select the desired units type from the **Pressure Units** list.
 - **psi**—pounds per square inch, lb/in²
 - **bar**—absolute cgs unit of pressure, dyne/cm²
 - **kPa**—mks unit of pressure, 10³ N/m²
- 5 Press **Apply**. The entered changes are saved to the GC.



10 Resource Conservation

Resource Conservation	146
Sleep Methods	147
Wake and Condition Methods	149
To Set the GC to Conserve Resources	150

This section describes the resource-saving features of the GC. When used with other instruments configured for enhanced communications, additional features become available for the GC-MS, GC-HS, or HS-GC-MS system. See “[Intelligent Instrument Features](#)” on page 191.



Resource Conservation

The Agilent Intuvo 9000 GC provides an instrument schedule to conserve resources such as electricity and gases. Using the instrument schedule, you can assign sleep, wake, and conditioning methods that allow you to program resource usage. A SLEEP method sets low flows and temperatures. A WAKE method sets new flows and temperatures, typically to restore operating conditions. A CONDITION method sets flows and temperatures for a specific run time, typically high enough to clean out contamination if present.

Load the sleep method at a specified time during the day to reduce flows and temperatures. Load the wake or condition method to restore analytical settings before operating the GC again. For example, load the sleep method at the end of each day or work week, then load the wake or condition method an hour or so before arriving to work the next day.

A method is the group of settings required to analyze a specific sample.

Since every type of sample reacts differently in the GC—some samples require a higher column temperature, others require a lower gas pressure or a different detector—a unique method must be created for each specific type of analysis.

The Agilent Intuvo 9000 GC touch screen provides access to a single method, referred to as the Active Method.

This method can be edited on the GC using the touch screen.

Additional methods can be created, edited, and stored on the GC using a connected data system. The connected data system can be used to change the active method on the GC.

Although these methods are not visually displayed on the GC, once downloaded to the GC from the data system, they can be used by the GC scheduler functionality.

Sleep Methods

Use a connected data system to create a sleep method to reduce gas and power usage during times of reduced activity.

When creating a sleep method, consider the following:

- The detector. While you can reduce temperatures and gas usage, consider the stabilization time required to prepare the detector for use. See [Table 1](#) on page 30. The power savings is minimal.
- Connected devices. If connected to an external device such as a mass spectrometer, set compatible flows and temperatures.
- The inlets. Maintain sufficient flow to prevent contamination.
- Cryo cooling. Devices which use cryo cooling may start immediately using cryogen if the wake method requires it.

See [Table 7](#) for general recommendations.

Table 7 Sleep method recommendations

GC Component	Comment
Columns	<ul style="list-style-type: none"> • Reduce temperature to save power. • Turn off to save the most power. • Maintain some carrier gas flow to protect the columns.
Inlets	For all inlets: <ul style="list-style-type: none"> • Reduce temperatures. Reduce temperatures to 40 °C or Off to save the most power.
Split/splitless	<ul style="list-style-type: none"> • Use split mode to prevent diffusion of contamination from the vent line. Use reduced split ratio. • Reduce pressure. Consider using current Gas Saver levels, if used.
Multimode	<ul style="list-style-type: none"> • Use split mode to prevent diffusion of contamination from the vent line. Use reduced split ratio. • Reduce pressure. Consider using current Gas Saver levels, if used.
Detectors	
FID	<ul style="list-style-type: none"> • Turn off the flame. (This turns off hydrogen and air flows.) • Reduce temperatures. (Keep at or above 100 °C to reduce contamination and condensation.) • Turn off makeup flow.
FPD ⁺	<ul style="list-style-type: none"> • Turn off the flame. (This turns off hydrogen and air flows.) • Reduce temperatures. (Keep at or above 100 °C to reduce contamination and condensation.) • Turn off makeup flow.

Table 7 Sleep method recommendations

GC Component	Comment
ECD	<ul style="list-style-type: none"> • Reduce makeup flow. Try using 15–20 mL/min and test results. • Maintain temperature to avoid long recovery/stabilization times.
NPD	<ul style="list-style-type: none"> • Maintain flows and temperatures. Sleep not recommended due to recovery times and also thermal cycling can reduce bead life.
TCD	<ul style="list-style-type: none"> • Leave filament on. • Leave block temperature on. • Reduce reference and makeup flows.
Other devices	
Valve box	<ul style="list-style-type: none"> • Reduce temperature. (Keep valve box temperature high enough to prevent sample condensation, if applicable.)
Aux thermal zones	<ul style="list-style-type: none"> • Reduce or turn off. Also refer to the manuals for any connected device (for example, a connected MSD).
Aux pressures or flows	<ul style="list-style-type: none"> • Reduce or turn off as appropriate for connected columns, transfer lines, and so forth. Always refer to the manual for any connected device or instrument (for example, a connected MSD), to maintain at least the minimum recommended flows or pressures.

Wake and Condition Methods

The GC can be programmed to wake in one of several ways:

- By loading the last Active Method used before going to sleep
- By loading the WAKE method
- By running a method called CONDITION, then loading the last Active Method
- By running a method called CONDITION, then loading the WAKE method

NOTE

The GC can also store wake, sleep, and condition methods which have been created by the browser UI or a connected data system. Although these methods are not visually displayed on the GC, once downloaded to the GC from the data system, they can be used by the GC scheduler functionality.

These choices provide flexibility in how you prepare the GC after a sleep cycle.

A **WAKE method** sets a temperatures and flows. The oven temperature program is isothermal since the GC does not start a run. When the GC loads a **WAKE** method, it remains at those settings until you load another method using the touch screen, data system, or by starting a sequence.

A **WAKE** method can include any settings, however it typically will do the following:

- Restore inlet, detector, column, and transfer line flows.
- Restore temperatures.
- Ignite the FID or FPD⁺ flame.
- Restore inlet modes.

A **CONDITION method** sets flows and temperatures for the duration of the method's oven program. When the program ends, the GC loads either the **WAKE** method or the last Active Method before sleep, as specified in the instrument schedule (or when manually exiting the sleep state).

One possible use for a condition method is to set higher than normal temperatures and flows to bake out any possible contamination that may have collected in the GC during sleep.

To Set the GC to Conserve Resources

To set the GC to conserve resources by creating and using an **Instrument Schedule**:

- 1 Press **Settings** on the touch screen control ribbon. The Settings view appears. See [Figure 65](#).

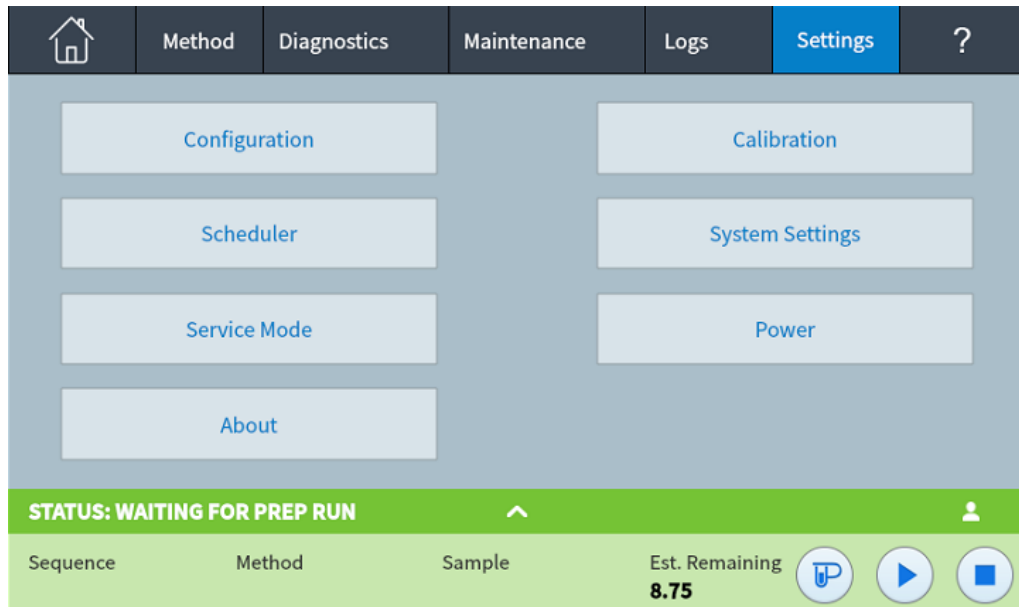
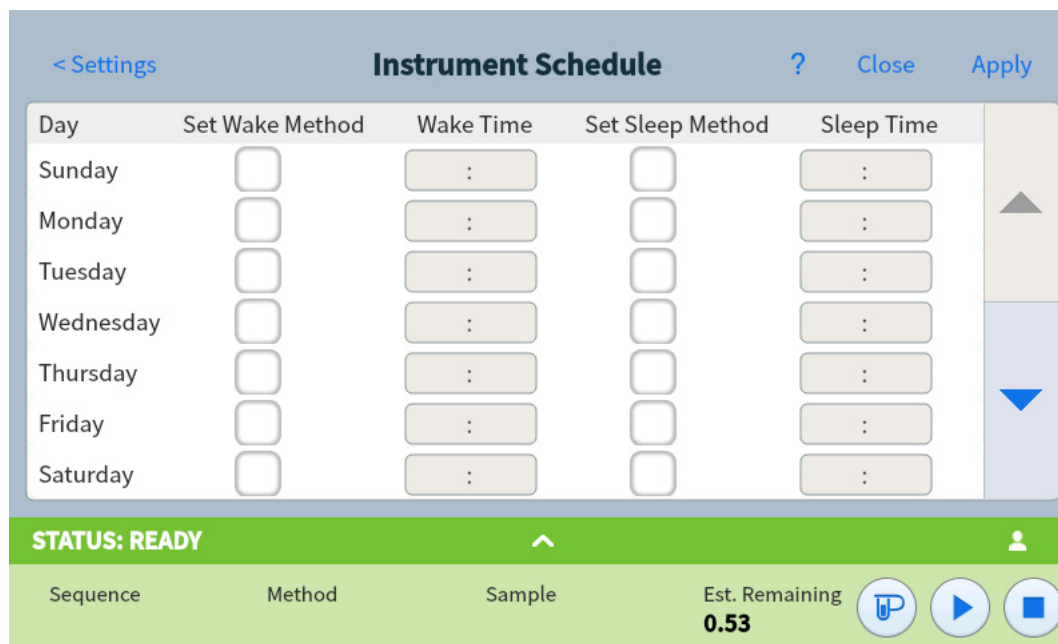

Figure 65 Settings view

- 2 Press **Scheduler**. The Instrument Schedule page appears. See [Figure 66](#).



Day	Set Wake Method	Wake Time	Set Sleep Method	Sleep Time
Sunday	<input type="checkbox"/>	:	<input type="checkbox"/>	:
Monday	<input type="checkbox"/>	:	<input type="checkbox"/>	:
Tuesday	<input type="checkbox"/>	:	<input type="checkbox"/>	:
Wednesday	<input type="checkbox"/>	:	<input type="checkbox"/>	:
Thursday	<input type="checkbox"/>	:	<input type="checkbox"/>	:
Friday	<input type="checkbox"/>	:	<input type="checkbox"/>	:
Saturday	<input type="checkbox"/>	:	<input type="checkbox"/>	:

STATUS: READY

Sequence Method Sample Est. Remaining 0.53

Figure 66 Instrument Schedule page

- 3 Create the **Instrument Schedule**. You do not have to program events for every day. For example, you can program the GC to sleep on Friday evening, then wake on Monday morning, keeping it continuously at operating conditions during weekdays.
 - a Enter a **Wake Time** for each desired day.
 - b Enter a **Sleep Time** for each desired day.
 - c Choose **Set Wake Method** for each desired day, as applicable. This will cause the Wake method to be run when the GC wakes on the selected days. (See [“Wake and Condition Methods”](#) on page 149.)
 - d Choose **Set Sleep Method** for each desired day, as applicable. This will cause the Sleep method to be run prior to the GC going to sleep on the selected days. (See [“Sleep Methods”](#) on page 147.)
- 4 Scroll to the Scheduler Options area. See [Figure 67](#).

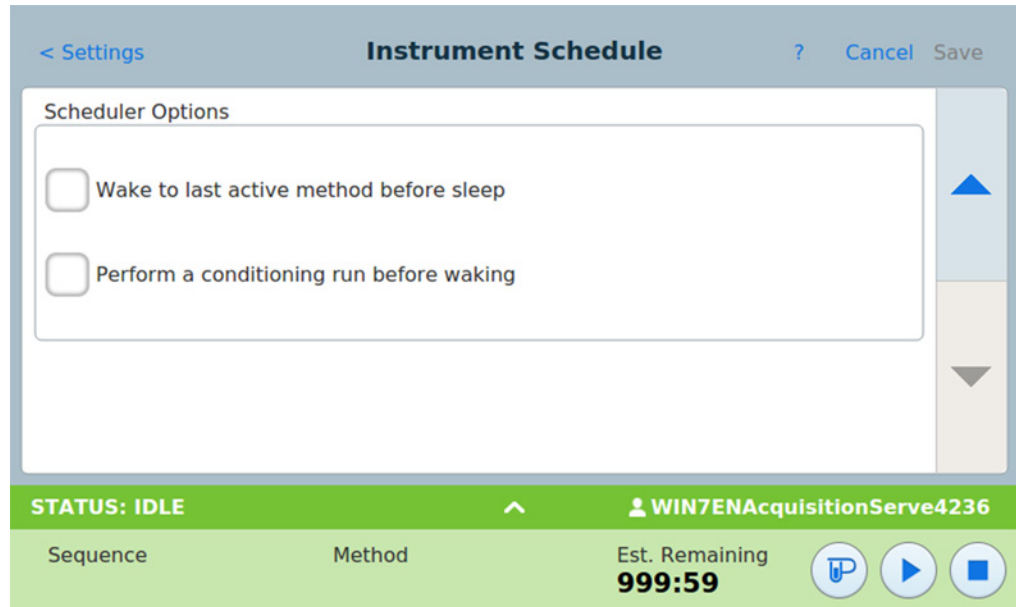
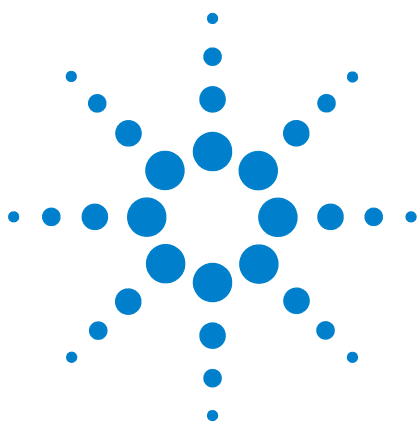

Figure 67 Scheduler Options area

- 5 Decide how to restore flows. Choose the desired options:
 - Wake to last active method before sleep: At the specified time, the GC will restore the last Active Method used before it went to sleep.
 - Perform a conditioning run before waking: At the specified time, the GC will load the condition method. This method runs once. See [“Wake and Condition Methods”](#) on page 149.)
- 6 Press **Save**. The settings are saved to the GC.



11 Programming

Clock Time Programming	154
Using clock time events	154
Adding events to the clock table	154
Deleting clock time events	155

Clock Time Programming

Clock time programming allows certain setpoints to change automatically at a specified time during a 24-hour day. Thus, an event programmed to occur at 14:35 hours will occur at 2:35 in the afternoon. A running analysis or sequence has precedence over any clock table events occurring during this time. When this happens, such events are not executed.

Possible clock time events include:

- Valve control
- Method and sequence loading
- Starting sequences
- Initiating blank and prep runs
- Column compensation changes
- Adjustments of the detector offset

Using clock time events

The Clock Table function allows you to program events to occur during a day based on the 24-hour clock. Clock table events that would occur during a run or sequence are ignored.

For example, the clock table could be used to make a blank run before you even get to work in the morning.

Adding events to the clock table

- 1 Select **Settings** on the touchscreen.
- 2 Select **Scheduler** in the right column of options.
- 3 Select the down arrow on the right side to view the clock table.

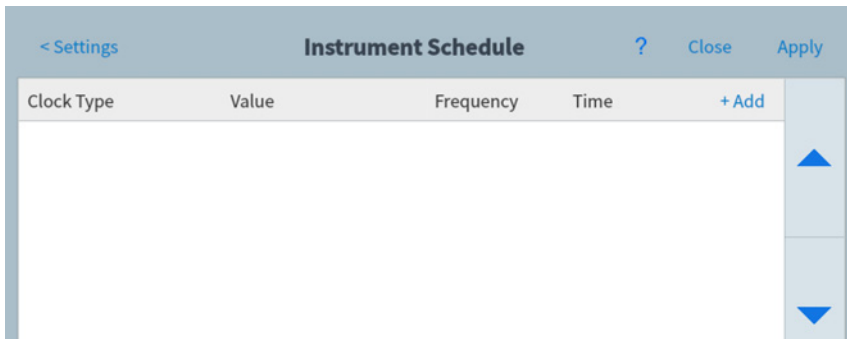

- 4 Select **+Add**.

- 5 Choose your Clock Type and Frequency from their respective dropdown menus.
- 6 Set the Time you want this event to occur at.
- 7 Select **Add** to add this entry to the clock table.
- 8 Repeat this process until all entries are added.

Deleting clock time events

- 1 Select **Settings** on the touchscreen.
- 2 Select **Scheduler** in the left column of options.
- 3 Select the down arrow on the right side to view the clock table.
- 4 Select the **X** to the right of the desired event. You will be asked to confirm the deletion.
- 5 Select **Yes** to delete the event.

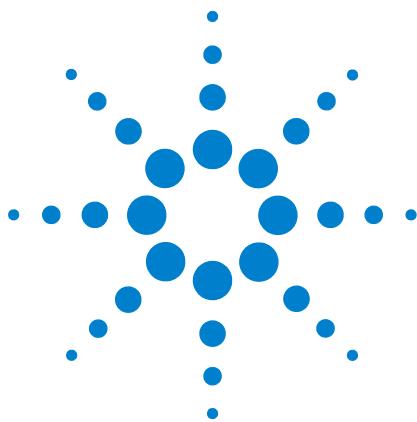

12 Chromatographic Checkout

About Chromatographic Checkout	158
To Prepare for Chromatographic Checkout	159
To Check FID Performance	160
To Check TCD Performance	164
To Check NPD Performance	168
To Check ECD Performance	172
To Check FPD ⁺ Performance (Sample 5188-5953)	177
Preparation	177
Phosphorus performance	178
Sulfur performance	181
To Check FPD ⁺ Performance (Sample 5188-5245, Japan)	183
Preparation	183
Phosphorus performance	184
Sulfur performance	188

This section describes the general procedure for verifying performance against the original factory standards. The checkout procedures described here assume a GC that has been in use for some period of time. Therefore the procedures ask that you perform bakeouts, replace consumable hardware, install the checkout column, and so forth. For a new GC installation, refer to the *Agilent Intuvo 9000 Installation Guide* for the steps you can skip in this case.



About Chromatographic Checkout

The tests described in this section provide basic confirmation that the GC and detectors can perform comparably to factory conditions. However, as detectors and the other parts of the GC age, detector performance can change. The results presented here represent typical outputs for typical operating conditions and are not specifications.

The tests assume the following:

- Use of an automatic liquid sampler. If not available, use a suitable manual syringe instead of the syringe listed.
- Use of a 10 μL syringe in most cases. However, a 5 μL syringe is an acceptable substitute.
- Use of the septa and other hardware (liners, filters, and so on) described. If you substitute other hardware, performance can vary.

To Prepare for Chromatographic Checkout

Because of the differences in chromatographic performance associated with different consumables, Agilent strongly recommends using the parts listed here for all checkout tests. Agilent also recommends installing new consumable parts whenever the quality of the installed ones is not known. For example, installing a new liner and septum ensures that they will not contribute any contamination to the results.

When the GC is delivered from the factory, these consumable parts are new and do not need replacement.

NOTE

For a new GC, check the installed inlet liner. The liner shipped in the inlet may not be the liner recommended for checkout.

- 1 Check the indicators/dates on any gas supply traps. Replace/recondition expended traps.
- 2 Install new consumable parts for the inlet and prepare the correct injector syringe (and needle, as needed).

Table 8 Recommended parts for checkout by inlet type

Recommended part for checkout	Part number
Split splitless inlet	
Syringe, 10- μ L	5181-1267
O-ring	5188-5365
Septum	5183-4757
Liner	5062-3587 or 5181-3316
Multimode inlet	
Syringe, 10- μ L	5181-1267
O-ring	5188-6405
Septum	5183-4757
Liner	5190-3163

To Check FID Performance

- 1 Gather the following:
 - Evaluation column, HP-5 30 m × 0.32 mm × 0.25 μm (19091S-413UI-INT)
 - FID performance evaluation (checkout) sample (5188-5372)
 - Chromatographic-grade isooctane
 - 4-mL solvent and waste bottles or equivalent for autoinjector
 - 2-mL sample vials or equivalent for sample
 - Inlet and injector hardware (See [“To Prepare for Chromatographic Checkout”](#) on page 159.)
- 2 Verify the following:
 - Chromatographic-grade gases plumbed and configured: helium as carrier gas, nitrogen, hydrogen, and air.
 - Empty waste vials loaded in sample turret.
 - 4-mL solvent vial with diffusion cap filled with isooctane and inserted in Solvent A injector position.
- 3 Replace consumable parts (liner, septum, traps, syringe, and so forth) as needed for the checkout. See [“To Prepare for Chromatographic Checkout”](#) on page 159.
- 4 Install the evaluation column. (Refer to the procedure for the SS or MMI inlet in the *Agilent Intuvo 9000 Gas Chromatograph Maintaining Your GC* guide.)
 - Bake out the evaluation column for at least 30 min at 180 °C. (Refer to the procedure for the SS or MMI inlet in the *Agilent Intuvo 9000 Gas Chromatograph Maintaining Your GC* guide.)
- 5 Check the FID baseline output. (Refer to the procedure for the FID detector in the *Agilent Intuvo 9000 Gas Chromatograph Maintaining Your GC* guide.) The output should be between 5 pA and 20 pA and relatively stable. (If using a gas generator or ultra pure gas, the signal may stabilize below 5 pA.) If the output is outside this range, or unstable, resolve this problem before continuing.
- 6 If the output is too low:
 - Check that the electrometer is on.
 - Check that the flame is lit.
 - Check that the signal is set to the correct detector.

- 7 Create or load a method with the parameter values listed in Table 9.

Table 9 FID Checkout Conditions

Column and sample	
Type	HP-5, 30 m × 0.32 mm × 0.25 μm (19091S-413UI-INT)
Sample	FID checkout 5188-5372
Column flow	6.5 mL/min
Column mode	Constant flow
Split/splitless inlet	
Temperature	250 °C
Mode	Splitless
Purge flow	40 mL/min
Purge time	0.5 min
Septum purge	3 mL/min
Gas saver	Off
Guard chip heater mode	Track Oven
Bus heater setting	Use default
Multimode inlet	
Mode	Splitless
Inlet temperature	75 °C
Initial time	0.1 min
Rate 1	720 °C/min
Final temp 1	250 °C
Final time 1	5.0 min
Purge time	1.0 min
Purge flow	40 mL/min
Septum purge	3 mL/min
Guard chip heater mode	Track Oven
Bus heater setting	Use default
Detector	
Temperature	300 °C
H2 flow	30 mL/min

Table 9 FID Checkout Conditions (continued)

Air flow	400 mL/min
Makeup flow (N2)	25 mL/min
Lit offset	Typically 2 pA
Oven	
Initial temp	75 °C
Initial time	0.5 min
Rate 1	20 °C/min
Final temp	190 °C
Final time	0 min
ALS settings (if installed)	
Sample washes	2
Sample pumps	6
Sample wash volume	8 (maximum)
Injection volume	1 µL
Syringe size	10 µL
Solvent A pre washes	2
Solvent A post washes	2
Solvent A wash volume	8
Solvent B pre washes	0
Solvent B post washes	0
Solvent B wash volume	0
Injection mode (7693A)	Normal
Airgap Volume (7693A)	0.20
Viscosity delay	0
Inject Dispense Speed (7693A)	6000
PreInjection dwell	0
PostInjection dwell	0
Manual injection	
Injection volume	1 µL
Data system	
Data rate	5 Hz



- 8 If using a data system, prepare the data system to perform one run using the loaded checkout method. Make sure that the data system will output a chromatogram.

If not using a data system, create a one sample sequence using the GC touch screen.

- 9 Start the run.

If performing an injection using an autosampler, start the run using the data system or navigate to the **Status** screen on the GC touch screen and press **Start** .

If performing a manual injection (with or without a data system):

- a Press **Prep Run**  to prepare the inlet for splitless injection.
- b When the GC becomes ready, inject 1 μL of the checkout sample and press **Start** .

The following chromatogram shows typical results for a new detector with new consumable parts installed and nitrogen makeup gas.

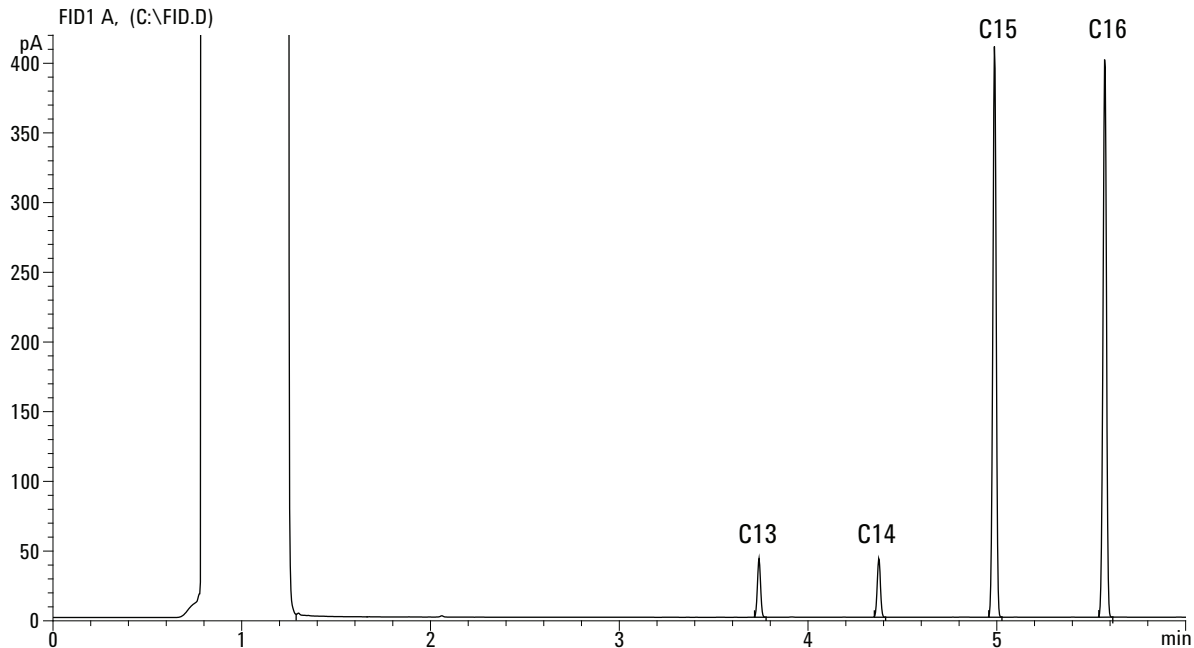

To Check TCD Performance

- 1 Gather the following:
 - Evaluation column, HP-5 30 m × 0.32 mm × 0.25 μm (19091S-413UI-INT)
 - FID/TCD performance evaluation (checkout) sample (18710-60170)
 - 4-mL solvent and waste bottles or equivalent for autoinjector
 - Chromatographic-grade hexane
 - 2-mL sample vials or equivalent for sample
 - Chromatographic-grade helium as carrier, makeup, and reference gas
 - Inlet and injector hardware (See [“To Prepare for Chromatographic Checkout”](#) on page 159.)
- 2 Verify the following:
 - Chromatographic-grade gases plumbed and configured: helium as carrier gas and reference gas.
 - Empty waste vials loaded in sample turret.
 - 4-mL solvent vial with diffusion cap filled with hexane and inserted in Solvent A injector position.
- 3 Replace consumable parts (liner, septum, traps, syringe, and so forth) as needed for the checkout. See [“To Prepare for Chromatographic Checkout”](#) on page 159.
- 4 Install the evaluation column. (Refer to the procedure for the SS or MMI inlet in the *Agilent Intuvo 9000 Gas Chromatograph Maintaining Your GC* guide.)
 - Bake out the evaluation column for at least 30 min at 180 °C. (Refer to the procedure for the SS or MMI inlet in the *Agilent Intuvo 9000 Gas Chromatograph Maintaining Your GC* guide.)
- 5 Create or load a method with the parameter values listed in [Table 10](#).

Table 10 TCD Checkout Conditions

Column and sample	
Type	HP-5, 30 m × 0.32 mm × 0.25 μm (19091S-413UI-INT)
Sample	FID/TCD checkout 18710-60170

Table 10 TCD Checkout Conditions (continued)

Column flow	6.5 mL/min
Column mode	Constant flow
Split/splitless inlet	
Temperature	250 °C
Mode	Splitless
Purge flow	60 mL/min
Purge time	0.75 min
Septum purge	3 mL/min
Guard chip heater mode	Track Oven
Bus heater setting	Use default
Multimode inlet	
Mode	Splitless
Inlet temperature	40 °C
Initial time	0.1 min
Rate 1	720 °C/min
Final temp 1	350 °C
Final time 1	2 min
Purge time	1.0 min
Purge flow	40 mL/min
Septum purge	3 mL/min
Guard chip heater mode	Track Oven
Bus heater setting	Use default
Detector	
Temperature	300 °C
Reference flow (He)	30 mL/min
Makeup flow (He)	2 mL/min
Baseline output	< 30 display counts on Agilent OpenLab CDS ChemStation Edition (< 750 μ V)
Oven	
Initial temp	75 °C
Initial time	0.5 min

Table 10 TCD Checkout Conditions (continued)



Rate 1	20 °C/min
Final temp	190 °C
Final time	0 min
ALS settings (if installed)	
Sample washes	2
Sample pumps	6
Sample wash volume	8 (maximum)
Injection volume	1 µL
Syringe size	10 µL
Solvent A pre washes	2
Solvent A post washes	2
Solvent A wash volume	8
Solvent B pre washes	0
Solvent B post washes	0
Solvent B wash volume	0
Injection mode (7693A)	Normal
Airgap Volume (7693A)	0.20
Viscosity delay	0
Inject Dispense Speed (7693A)	6000
PreInjection dwell	0
PostInjection dwell	0
Manual injection	
Injection volume	1 µL
Data system	
Data rate	5 Hz

- 6** Display the signal output. A stable output at any value between 12.5 and 750 µV (inclusive) is acceptable.
- If the baseline output is < 0.5 display units (< 12.5 µV), verify that the detector filament is on. If the offset is still < 0.5 display units (< 12.5 µV), your detector requires service.

- If baseline output is > 30 display units ($> 750 \mu\text{V}$), there may be chemical contamination contributing to the signal. bakeout the TCD. (Refer to the bakeout procedure for the TCD in the *Agilent Intuvo 9000 Gas Chromatograph Maintaining Your GC* guide.) If repeated cleanings do not give an acceptable signal, check gas purity. Use higher purity gases and/or install traps.
- 7 If using a data system, prepare the data system to perform one run using the loaded checkout method. Make sure that the data system will output a chromatogram.
 - 8 Start the run.

If performing an injection using an autosampler, start the run using the data system or navigate to the **Status** screen on the GC touch screen and press **Start** .

If performing a manual injection (with or without a data system):

- a Press **Prep Run**  to prepare the inlet for splitless injection.
- b When the GC becomes ready, inject $1 \mu\text{L}$ of the checkout sample and press **Start** .

The following chromatogram shows typical results for a new detector with new consumable parts installed.

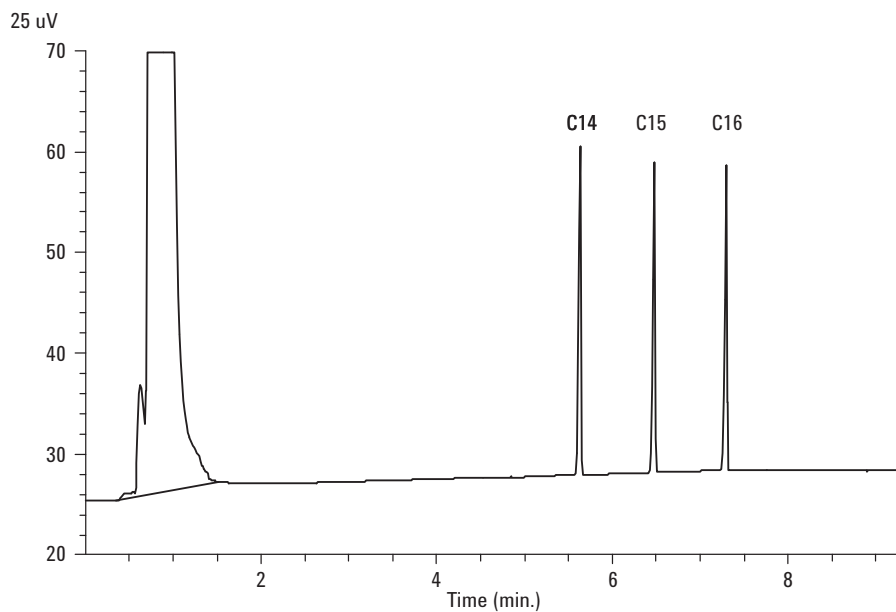

To Check NPD Performance

- 1 Gather the following:
 - Evaluation column, HP-5 30 m × 0.32 mm × 0.25 μm (19091S-413UI-INT)
 - NPD performance evaluation (checkout) sample (18789-60060)
 - 4-mL solvent and waste bottles or equivalent for autoinjector.
 - Chromatographic-grade isooctane
 - 2-mL sample vials or equivalent for sample.
 - Inlet and injector hardware (See [“To Prepare for Chromatographic Checkout”](#) on page 159.)
- 2 Verify the following:
 - Chromatographic-grade gases plumbed and configured: helium as carrier gas, nitrogen, hydrogen, and air.
 - Empty waste vials loaded in sample turret.
 - 4-mL vial with diffusion cap filled with isooctane and inserted in Solvent A injector position.
- 3 Replace consumable parts (liner, septum, traps, syringe, and so forth) as needed for the checkout. See [“To Prepare for Chromatographic Checkout”](#) on page 159.
- 4 If present, remove any protective caps from the inlet manifold vents.
- 5 Install the evaluation column. (Refer to the procedure for the SS or MMI inlet in the *Agilent Intuvo 9000 Gas Chromatograph Maintaining Your GC* guide.)
 - Bake out the evaluation column for at least 30 min at 180 °C. (Refer to the procedure for the SS or MMI inlet in the *Agilent Intuvo 9000 Gas Chromatograph Maintaining Your GC* guide.)
- 6 Create or load a method with the parameter values listed in [Table 11](#).

Table 11 NPD Checkout Conditions

Column and sample	
Type	HP-5, 30 m × 0.32 mm × 0.25 μm (19091S-413UI-INT)
Sample	NPD checkout 18789-60060

Table 11 NPD Checkout Conditions (continued)

Column mode	Constant flow
Column flow	6.5 mL/min (helium)
Split/splitless inlet	
Temperature	200 °C
Mode	Splitless
Purge flow	60 mL/min
Purge time	0.75 min
Septum purge	3 mL/min
Guard chip heater mode	Track Oven
Bus heater setting	Use default
Multimode inlet	
Mode	Splitless
Inlet temperature	60 °C
Initial time	0.1 min
Rate 1	720 °C/min
Final temp 1	350 °C
Final time 1	2 min
Purge time	1.0 min
Purge flow	60 mL/min
Septum purge	3 mL/min
Guard chip heater mode	Track Oven
Bus heater setting	Use default
Detector	
Temperature	300 °C
H2 flow	3 mL/min
Air flow	60 mL/min
Makeup flow (N2)	3 mL/min
Carrier Gas Flow Correction	None (Constant makeup and fuel flow)
Output	20 display units (20 pA)
Oven	
Initial temp	60 °C
Initial time	0 min

Table 11 NPD Checkout Conditions (continued)

Rate 1	20 °C/min
Final temp	200 °C
Final time	3 min
ALS settings (if installed)	
Sample washes	2
Sample pumps	6
Sample wash volume	8 (maximum)
Injection volume	1 µL
Syringe size	10 µL
Solvent A pre washes	2
Solvent A post washes	2
Solvent A wash volume	8
Solvent B pre washes	0
Solvent B post washes	0
Solvent B wash volume	0
Injection mode (7693A)	Normal
Airgap Volume (7693A)	0.20
Viscosity delay	0
Inject Dispense Speed (7693A)	6000
PreInjection dwell	0
PostInjection dwell	0
Manual injection	
Injection volume	1 µL
Data system	
Data rate	5 Hz

- 7 If using a data system, prepare the data system to perform one run using the loaded checkout method. Make sure that the data system will output a chromatogram.
- 8 Start the run.

If performing an injection using an autosampler, start the run using the data system, or navigate to the **Status** screen on the GC touch screen and press **Start** .

If performing a manual injection (with or without a data system):

- a Press **Prep Run**  to prepare the inlet for splitless injection.

When the GC becomes ready, inject 1 μL of the checkout sample and press **Start** .

The following chromatogram shows typical results for a new detector with new consumable parts installed.

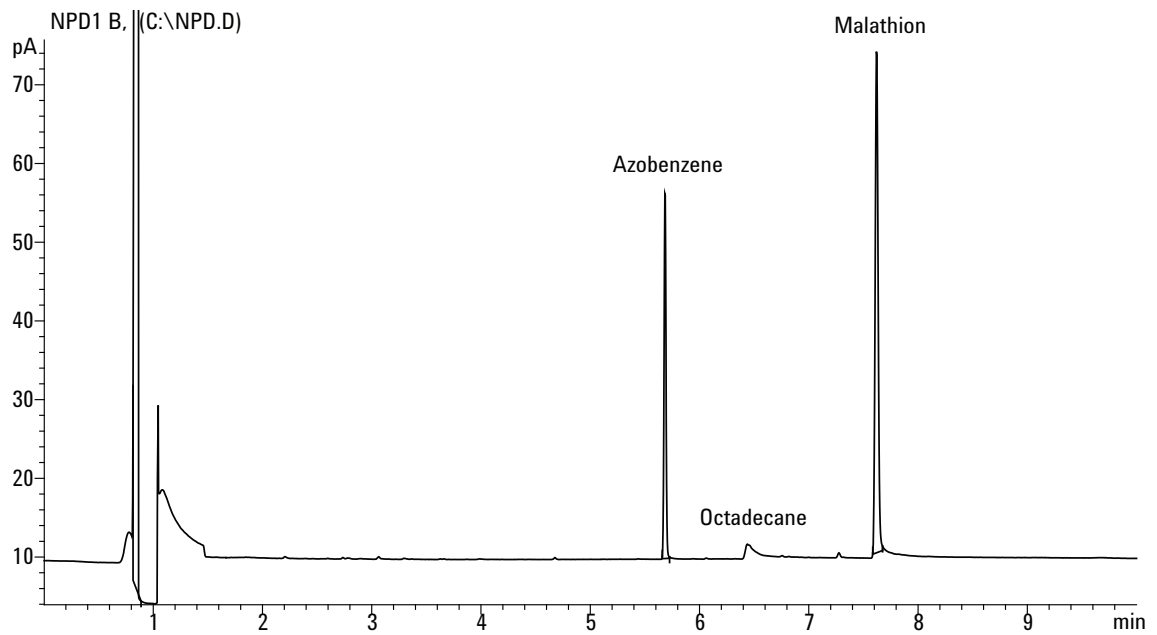

To Check ECD Performance

- 1 Gather the following:
 - Evaluation column, HP-5 30 m × 0.32 mm × 0.25 μm (19091S-413UI-INT)
 - ECD performance evaluation (checkout) sample (18713-60040, Japan: 5183-0379)
 - 4-mL solvent and waste bottles or equivalent for autoinjector.
 - Chromatographic-grade isooctane
 - 2-mL sample vials or equivalent for sample.
 - Inlet and injector hardware (See [“To Prepare for Chromatographic Checkout”](#) on page 159.)
- 2 Verify the following:
 - Chromatographic-grade gases plumbed and configured: helium for carrier gas, nitrogen for makeup.
 - Empty waste vials loaded in sample turret.
 - 4-mL vial with diffusion cap filled with hexane and inserted in Solvent A injector position.
- 3 Replace consumable parts (liner, septum, traps, syringe, and so forth) as needed for the checkout. See [“To Prepare for Chromatographic Checkout”](#) on page 159.
- 4 Install the evaluation column. (Refer to the procedure for the SS or MMI inlet in the *Agilent Intuvo 9000 Gas Chromatograph Maintaining Your GC* guide.)
 - Bake out the evaluation column for at least 30 minutes at 180 °C. (Refer to the procedure for the SS or MMI inlet in the *Agilent Intuvo 9000 Gas Chromatograph Maintaining Your GC* guide.)
- 5 Display the signal output to determine baseline output. A stable baseline output at any value between 0.5 and 1000 Hz (OpenLab CDS ChemStation Edition display units) (inclusive) is acceptable.
 - If the baseline output is < 0.5 Hz, verify that the electrometer is on. If the offset is still < 0.5 Hz, your detector requires service.

- If the baseline output is > 1000 Hz, there may be chemical contamination contributing to the signal. Bakeout the ECD. (Refer to the ECD bakeout procedure in the *Agilent Intuvo 9000 Gas Chromatograph Maintaining Your GC* guide.) If repeated cleanings do not give an acceptable signal, check gas purity. Use higher purity gases and/or install traps.
- 6 Create or load a method with the parameter values listed in [Table 12](#).

Table 12 ECD Checkout Conditions

Column and sample	
Type	HP-5, 30 m × 0.32 mm × 0.25 μm (19091S-413UI-INT)
Sample	ECD checkout (18713-60040 or Japan: 5183-0379)
Column mode	Constant flow
Column flow	6.5 mL/min (helium)
Split/splitless inlet	
Temperature	200 °C
Mode	Splitless
Purge flow	60 mL/min
Purge time	0.75 min
Septum purge	3 mL/min
Guard chip heater mode	Track Oven
Bus heater setting	Use default
Multimode inlet	
Mode	Splitless
Inlet temperature	80 °C
Initial time	0.1 min
Rate 1	720 °C/min
Final temp 1	250 °C
Final time 1	5 min
Purge time	1.0 min
Purge flow	60 mL/min
Septum purge	3 mL/min

Table 12 ECD Checkout Conditions (continued)

Guard chip heater mode	Track Oven
Bus heater setting	Use default
Detector	
Temperature	300 °C
Makeup flow (N2)	30 mL/min (constant + makeup)
Baseline output	Should be < 1000 display counts. In Agilent OpenLab CDS ChemStation Edition (< 1000 Hz)
Oven	
Initial temp	80 °C
Initial time	0 min
Rate 1	15 °C/min
Final temp	180 °C
Final time	10 min
ALS settings (if installed)	
Sample washes	2
Sample pumps	6
Sample wash volume	8 (maximum)
Injection volume	1 µL
Syringe size	10 µL
Solvent A pre washes	2
Solvent A post washes	2
Solvent A wash volume	8
Solvent B pre washes	0
Solvent B post washes	0
Solvent B wash volume	0
Injection mode (7693A)	Normal
Airgap Volume (7693A)	0.20
Viscosity delay	0
Inject Dispense Speed (7693A)	6000
PreInjection dwell	0
PostInjection dwell	0

Table 12 ECD Checkout Conditions (continued)



Manual injection	
Injection volume	1 μ L
Data system	
Data rate	5 Hz

7 If using a data system, prepare the data system to perform one run using the loaded checkout method. Make sure that the data system will output a chromatogram.

8 Start the run.

If performing an injection using an autosampler, start the run using the data system or navigate to the **Status** screen on the GC touch screen and press **Start** .

If performing a manual injection (with or without a data system):

- a** Press **Prep Run**  to prepare the inlet for splitless injection.
- b** When the GC becomes ready, inject 1 μ L of the checkout sample and press **Start** .

The following chromatogram shows typical results for a new detector with new consumable parts installed. The Aldrin peak will be missing when using the Japanese sample 5183-0379.

12 Chromatographic Checkout

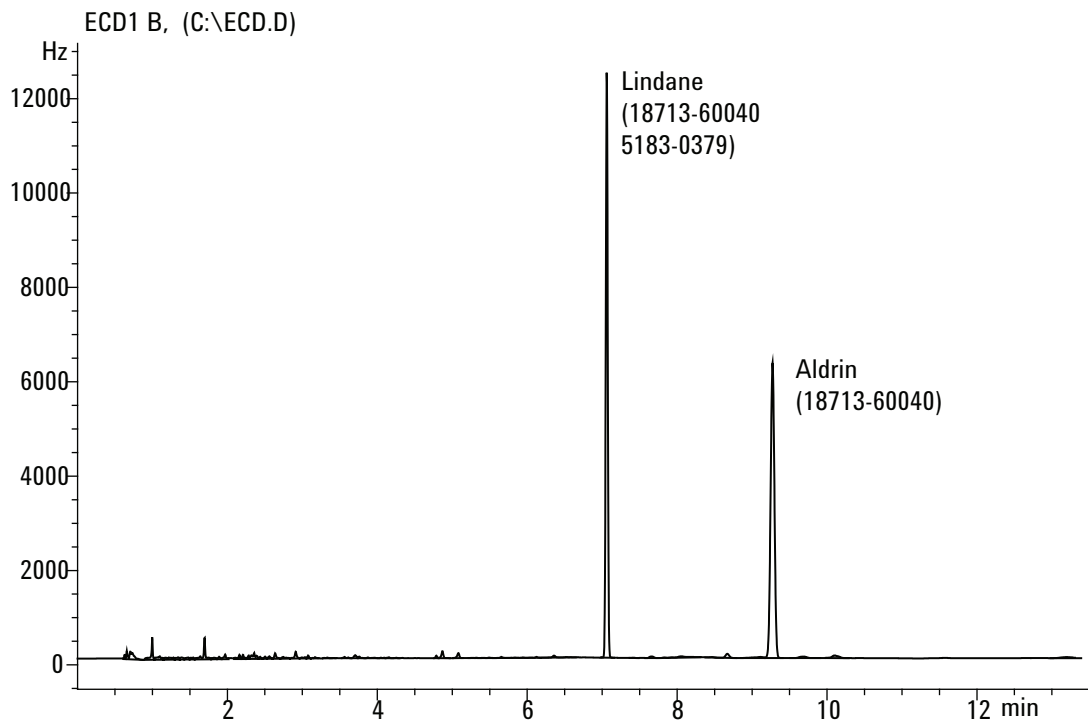

To Check FPD⁺ Performance (Sample 5188-5953)

To check FPD⁺ performance, first check the phosphorus performance, then the sulfur performance.

Preparation

- 1 Gather the following:
 - Evaluation column, HP-5 30 m × 0.32 mm × 0.25 μm (19091S-413UI-INT)
 - FPD performance evaluation (checkout) sample (5188-5953), 2.5 mg/L (± 0.5%) methylparathion in isooctane
 - Phosphorus filter
 - Sulfur filter and filter spacer
 - 4-mL solvent and waste bottles or equivalent for autoinjector.
 - 2-mL sample vials or equivalent for sample.
 - Chromatographic-grade isooctane for syringe wash solvent.
 - Inlet and injector hardware (See [“To Prepare for Chromatographic Checkout”](#) on page 159.)
- 2 Verify the following:
 - Chromatographic-grade gases plumbed and configured: helium as carrier gas, nitrogen, hydrogen, and air.
 - Empty waste vials loaded in sample turret.
 - 4-mL vial with diffusion cap filled with isooctane and inserted in Solvent A injector position.
- 3 Replace consumable parts (liner, septum, traps, syringe, and so forth) as needed for the checkout. See [“To Prepare for Chromatographic Checkout”](#) on page 159.
- 4 Verify that the **Lit Offset** is set appropriately. Typically, it should be about 2.0 pA for the checkout method.
- 5 Install the evaluation column. (Refer to the procedure for the SS or MMI inlet in the *Agilent Intuvo 9000 Gas Chromatograph Maintaining Your GC* guide.)
 - Set the oven, inlet, and detector to 250 °C and bake out for at least 15 minutes. (Refer to the procedure for the SS or MMI inlet in the *Agilent Intuvo 9000 Gas Chromatograph Maintaining Your GC* guide.)

Phosphorus performance

- 1 If it is not already installed, install the phosphorus filter.
(Refer to the FPD wavelength filter replacement procedure in the *Agilent Intuvo 9000 Gas Chromatograph Maintaining Your GC* guide.)
- 2 Create or load a method with the parameter values listed in [Table 13](#).

Table 13 FPD⁺ Checkout Conditions (P)

Column and sample	
Type	HP-5, 30 m × 0.32 mm × 0.25 μm (19091S-413UI-INT)
Sample	FPD checkout (5188-5953)
Column mode	Constant flow
Column flow	6.5 mL/min
Split/splitless inlet	
Temperature	180 °C Split/splitless
Mode	Splitless
Purge flow	60 mL/min
Purge time	0.75 min
Septum purge	3 mL/min
Guard chip heater mode	Track Oven
Bus heater setting	Use default
Multimode inlet	
Mode	Splitless
Inlet temperature	75 °C
Initial time	0.1 min
Rate 1	720 °C/min
Final temp 1	250 °C
Final time 1	5.0 min
Purge time	1.0 min
Purge flow	60 mL/min
Septum purge	3 mL/min
Guard chip heater mode	Track Oven

Table 13 FPD⁺ Checkout Conditions (continued)(P)

Bus heater setting	Use default
Detector	
Heater and Aux Transfer Line temp	200 °C
Emission Block Temperature	125 °C
Hydrogen flow	60 mL/min (On)
Air (Oxidizer) flow	60 mL/min (On)
Carrier Gas Flow Correction	None (Constant makeup flow)
Makeup flow	60 mL/min (On)
Makeup gas type	Nitrogen
Flame	On
Lit offset	Typically 2 pA
PMT voltage	On
Oven	
Initial temp	70 °C
Initial time	0 min
Rate 1	25 °C/min
Final temp	150 °C
Final time	0 min
Rate 2	5 °C/min
Final temp	190 °C
Final time	7 min
ALS settings (if installed)	
Sample washes	2
Sample pumps	6
Sample wash volume	8 (maximum)
Injection volume	1 µL
Syringe size	10 µL
Solvent A pre washes	2
Solvent A post washes	2
Solvent A wash volume	8
Solvent B pre washes	0
Solvent B post washes	0

Table 13 FPD⁺ Checkout Conditions (continued)(P)

Solvent B wash volume	0
Injection mode (7693A)	Normal
Airgap Volume (7693A)	0.20
Viscosity delay	0
Inject Dispense Speed (7693A)	6000
PreInjection dwell	0
PostInjection dwell	0
Manual injection	
Injection volume	1 μ L
Data system	
Data rate	5 Hz

- 3 Ignite the FPD flame, if not lit.
- 4 Display the signal output and monitor. This output typically runs between 40 and 55 but can be as high as 70. Wait for the output to stabilize. This takes approximately 1 hour.

If the baseline output is too high:

- Check for leaks.
- Bake out the detector and column at 250 °C.
- Wrong flows set for installed filter.

If the baseline output is zero, verify the electrometer is on and the flame is lit.

- 5 If using a data system, prepare the data system to perform one run using the loaded checkout method. Make sure that the data system will output a chromatogram.
- 6 Start the run.

If performing an injection using an autosampler, start the run using the data system or press **Start** on the GC.

If performing a manual injection (with or without a data system):

- a Press **Prep Run** to prepare the inlet for splitless injection.
- b When the GC becomes ready, inject 1 μ L of the checkout sample and press **Start** on the GC.
- c The following chromatogram shows typical results for a new detector with new consumable parts installed.

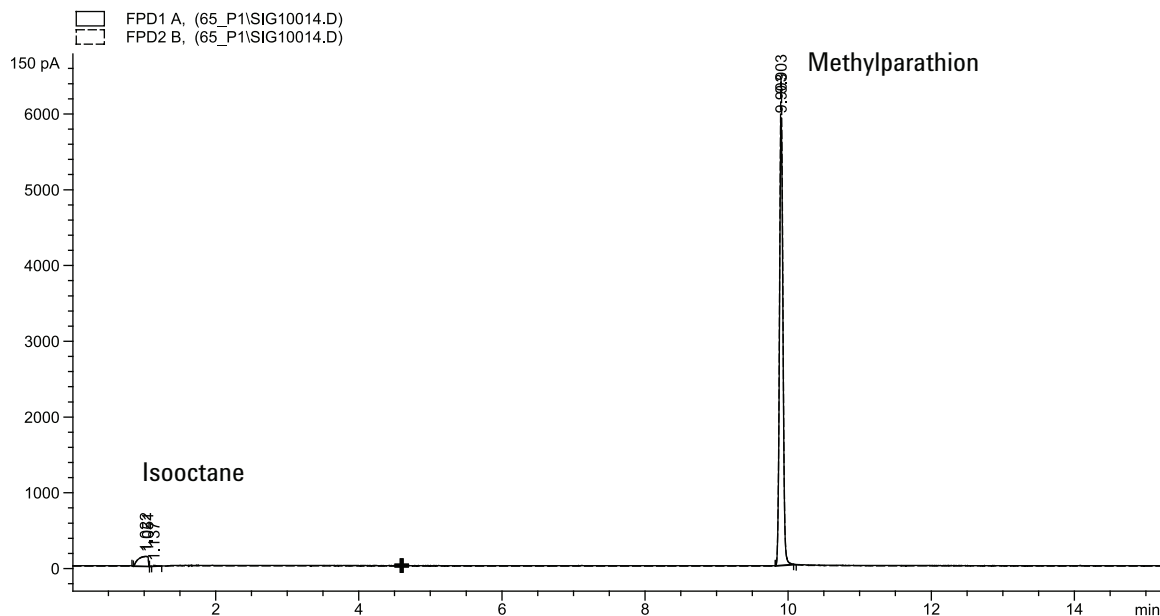

Sulfur performance

- 1 Install the sulfur filter and filter spacer. (Refer to the FPD wavelength filter replacement procedure in the *Agilent Intuvo 9000 Gas Chromatograph Maintaining Your GC* guide.)
- 2 Ignite the FPD flame if not lit.
- 3 Display the signal output and monitor. This output typically runs between 50 and 60 but can be as high as 70. Wait for the output to stabilize. This takes approximately 1 hour.

If the baseline output is too high:

- Check for leaks.
- Bake out the detector and column at 250 °C.
- Wrong flows set for installed filter.



If the baseline output is zero, verify the electrometer is on and the flame is lit.

- 4 If using a data system, prepare the data system to perform one run using the loaded checkout method. Make sure that the data system will output a chromatogram.
- 5 Start the run.

If performing an injection using an autosampler, start the run using the data system or navigate to the **Status** screen on the GC touch screen and press **Start** .

12 Chromatographic Checkout

If performing a manual injection (with or without a data system):

- a Press **Prep Run**  to prepare the inlet for splitless injection.
- b When the GC becomes ready, inject 1 μL of the checkout sample and press **Start** .

The following chromatogram shows typical results for a new detector with new consumable parts installed.

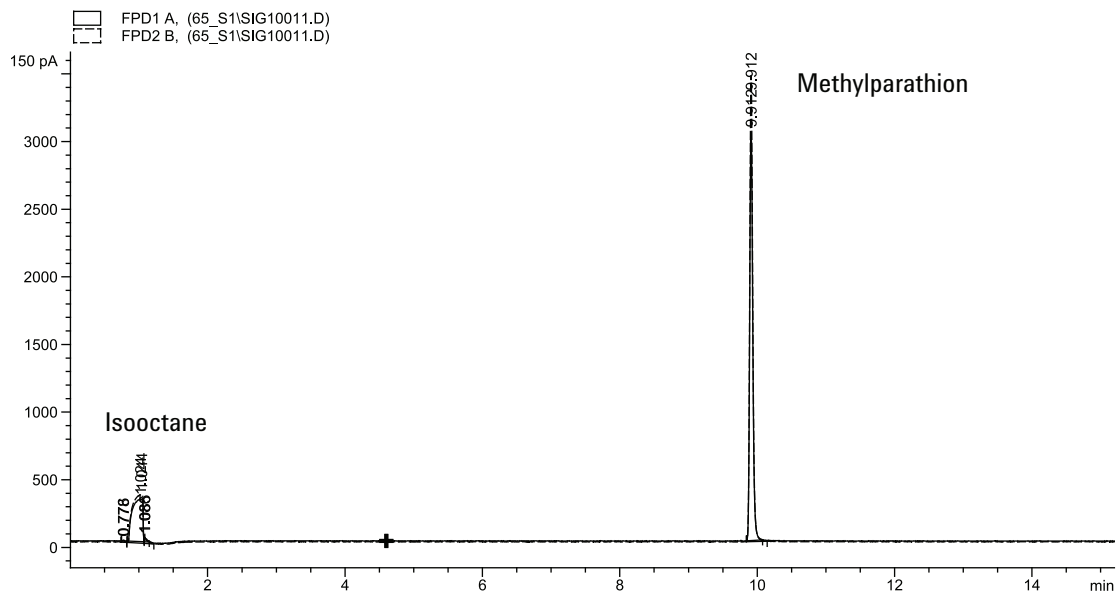

To Check FPD⁺ Performance (Sample 5188-5245, Japan)

To verify FPD⁺ performance, first check the phosphorus performance, then the sulfur performance.

Preparation

- 1 Gather the following:
 - Evaluation column, HP-5ms, Ultra Inert, 30 m × 0.32 mm × 0.25 μm (19091S-413UI-INT)
 - FPD performance evaluation (checkout) sample (5188-5245, Japan), composition: n-Dodecane 7499 mg/L (± 5%), Dodecanethiol 2.0 mg/L (± 5%), Tributyl Phosphate 2.0 mg/L (± 5%), tert-Butyldisulfide 1.0 mg/L (± 5%), in isooctane as solvent.
 - Phosphorus filter.
 - Sulfur filter and filter spacer.
 - 4-mL solvent and waste bottles or equivalent for autoinjector.
 - 2-mL sample vials or equivalent for sample.
 - Chromatographic-grade isooctane for syringe wash solvent.
 - Inlet and injector hardware (See [“To Prepare for Chromatographic Checkout”](#) on page 159.)
- 2 Verify the following:
 - Chromatographic-grade gases plumbed and configured: helium as carrier gas, nitrogen, hydrogen, and air.
 - Empty waste vials loaded in sample turret.
 - 4-mL vial with diffusion cap filled with isooctane and inserted in Solvent A injector position.
- 3 Replace consumable parts (liner, septum, traps, syringe, and so forth) as needed for the checkout. See [“To Prepare for Chromatographic Checkout”](#) on page 159.
- 4 Verify the lit offset is set appropriately. Typically, it should be about 2.0 pA for the checkout method.
- 5 Install the evaluation column. (Refer to the procedure for the SS or MMI inlet in the *Agilent Intuvo 9000 Gas Chromatograph Maintaining Your GC* guide.)

- Set the oven, inlet, and detector to 250 °C and bake out for at least 15 minutes. (Refer to the procedure for the SS or MMI inlet in the *Agilent Intuvo 9000 Gas Chromatograph Maintaining Your GC* guide.)

Phosphorus performance

- 1 If it is not already installed, install the phosphorus filter. (Refer to the FPD wavelength filter replacement procedure in the *Agilent Intuvo 9000 Gas Chromatograph Maintaining Your GC* guide.)
- 2 Create or load a method with the parameter values listed in [Table 14](#).

Table 14 FPD⁺ Phosphorus Checkout Conditions

Column and sample	
Type	HP-5ms, Ultra Inert, 30 m × 0.32 mm × 0.25 μm (19091S-413UI-INT)
Sample	FPD checkout (5188-5245)
Column mode	Constant flow
Column flow	7.5 mL/min
Split/splitless inlet	
Temperature	250 °C
Mode	Splitless
Total purge flow	69.5 mL/min
Purge flow	60 mL/min
Purge time	0.75 min
Septum purge	3 mL/min
Guard chip heater mode	Track Oven
Bus heater setting	Use default
Multimode inlet	
Mode	Splitless
Inlet temperature	80 °C
Initial time	0.1 min
Rate 1	720 °C/min
Final temp 1	250 °C
Final time 1	5.0 min

Table 14 FPD⁺ Phosphorus Checkout Conditions (continued)

Purge time	1.0 min
Purge flow	60 mL/min
Septum purge	3 mL/min
Guard chip heater mode	Track Oven
Bus heater setting	Use default
Detector	
Heater and Aux Transfer Line	200 °C (On)
Emission Block Temperature	125 °C
Hydrogen flow	60.0 mL/min (On)
Air (oxidizer) flow	60.0 mL/min (On)
Carrier Gas Flow Correction	None (Constant makeup and flow)
Makeup flow	60.0 mL/min (On)
Makeup gas type	Nitrogen
Flame	On
Lit offset	Typically 2 pA
PMT voltage	On
Oven	
Initial temp	70 °C
Initial time	0 min
Rate 1	10 °C/min
Final temp	105 °C
Final time	0 min
Rate 2	20 °C/min
Final temp	190 °C
Final time	7.25 min for sulfur 12.25 min for phosphorous
ALS settings (if installed)	
Sample washes	2
Sample pumps	6
Sample wash volume	8 (maximum)
Injection volume	1 µL
Syringe size	10 µL

Table 14 FPD⁺ Phosphorus Checkout Conditions (continued)

Solvent A pre washes	2
Solvent A post washes	2
Solvent A wash volume	8
Solvent B pre washes	0
Solvent B post washes	0
Solvent B wash volume	0
Injection mode (7693A)	Normal
Airgap Volume (7693A)	0.20
Viscosity delay	0
Inject Dispense Speed (7693A)	6000
PreInjection dwell	0
PostInjection dwell	0
Manual injection	
Injection volume	1 μ L
Data System	
Data rate	5 Hz

- 3 Ignite the FPD flame, if not lit.
- 4 Display the signal output and monitor. This output typically runs between 40 and 55 but can be as high as 70. Wait for the output to stabilize. This takes approximately 1 hour.

If the baseline output is too high:



- Check for leaks.
- Bake out the detector and column at 250 °C.
- Wrong flows set for installed filter.

If the baseline output is zero, verify the electrometer is on and the flame is lit.

- 5 If using a data system, prepare the data system to perform one run using the loaded checkout method. Make sure that the data system will output a chromatogram.
- 6 Start the run.

If performing an injection using an autosampler, start the run using the data system or navigate to the **Status** screen on the GC touch screen and press **Start** .

If performing a manual injection (with or without a data system):

- a Press **Prep Run**  to prepare the inlet for splitless injection.
- b When the GC becomes ready, inject 1 μL of the checkout sample and press **Start** .

The following chromatogram shows typical results for a new detector with new consumable parts installed.

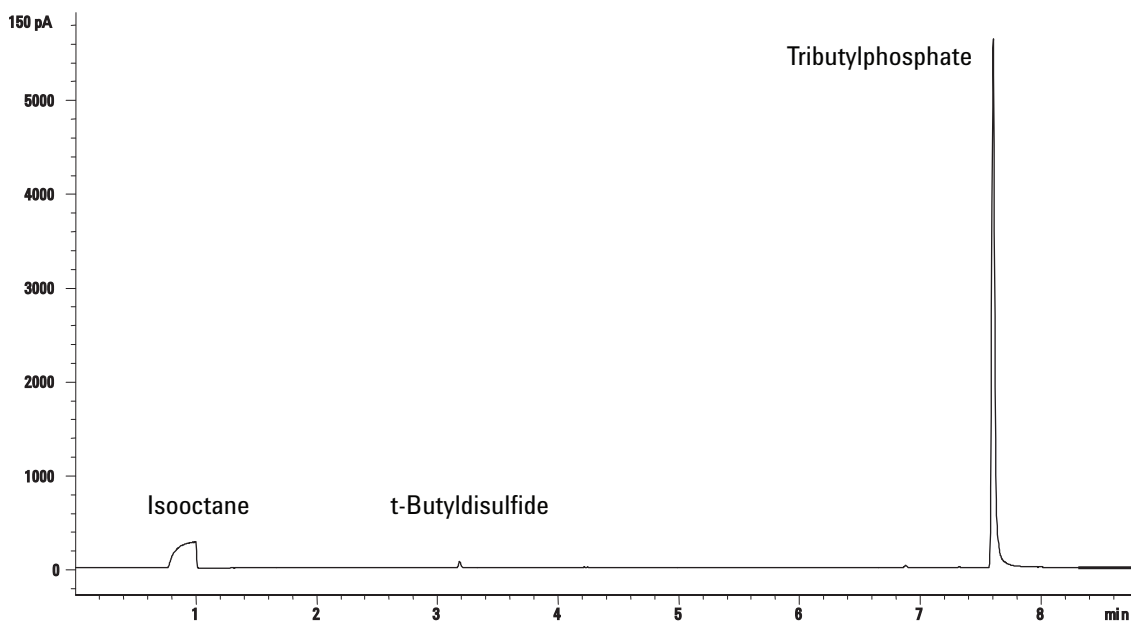

Table 15 Evaluating checkout runs

FPD P filter	Typical range after 24 hours	Limits at installation
MDL (pg/sec)	0.06 to 0.08	≤ 0.10
Peak area	19000 to 32000	≥ 19000
Signal height	5000 to 11000	—
Noise	1.6 to 3.0	≤ 4
Half-width (min)	0.05 to 0.07	—
Output	34 to 80	≤ 80

Sulfur performance

- 1 Install the sulfur filter. (Refer to the FPD wavelength filter replacement procedure in the *Agilent Intuvo 9000 Gas Chromatograph Maintaining Your GC* guide.)
- 2 Ignite the FPD flame, if not lit.
- 3 Display the signal output and monitor. This output typically runs between 50 and 60 but can be as high as 70. Wait for the output to stabilize. This takes approximately 2 hours.

If the baseline output is too high:



- Check for leaks.
- Bake out the detector and column at 250 °C.
- Wrong flows set for installed filter.

If the baseline output is zero, verify the electrometer is on and the flame is lit.

- 4 If using a data system, prepare the data system to perform one run using the loaded checkout method. Make sure the data system will output a chromatogram.
- 5 Start the run.

If performing an injection using an autosampler, start the run using the data system or navigate to the **Status** screen on the GC touch screen and press **Start** .

If performing a manual injection (with or without a data system):

- a Press **Prep Run**  to prepare the inlet for splitless injection.
- b When the GC becomes ready, inject 1 µL of the checkout sample and press **Start** .

The following chromatogram shows typical results for a new detector with new consumable parts installed.

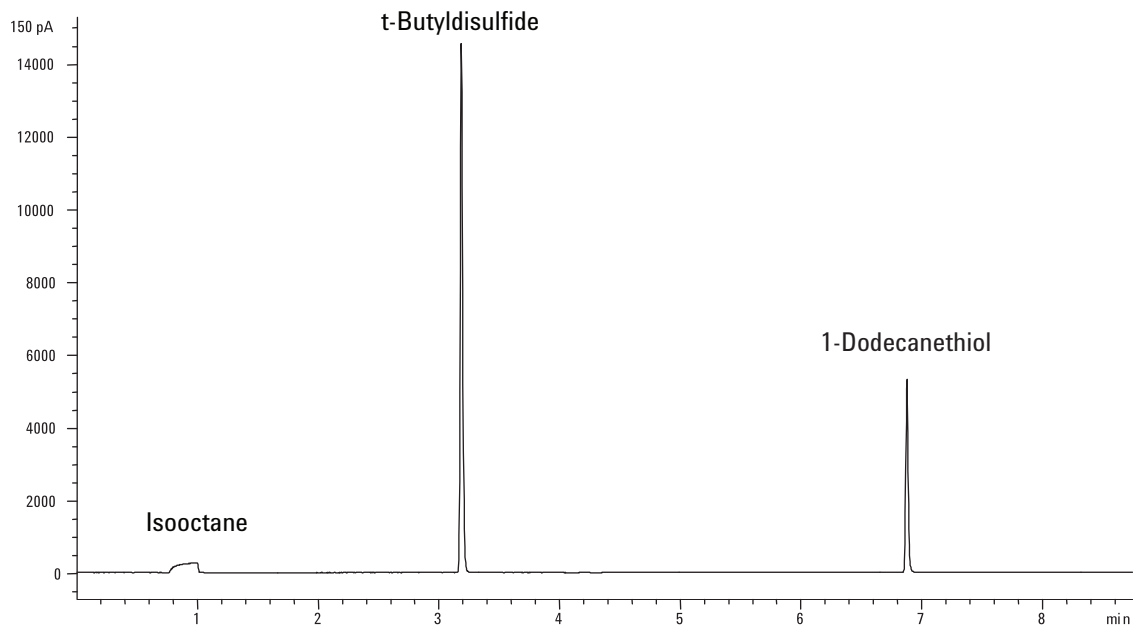

12 Chromatographic Checkout

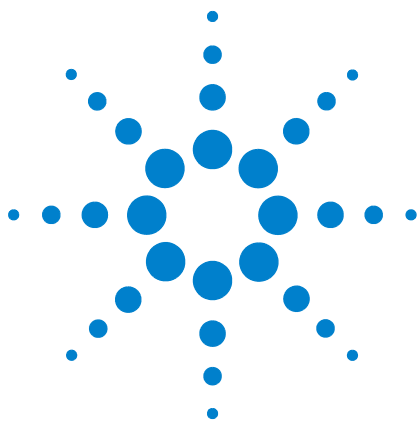

13 Intelligent Instrument Features

System-Level Communications	192
GC/MS Systems	193
Venting the MS	193
MS Shutdown events	193
GC Pressure Shutdown events	194

The Intuvo 9000 GC supports Agilent's Intelligent Instrument features. When multiple instruments that support this technology are configured as a system, the enhanced communications and data sharing between them provide features and capabilities that are not available in earlier systems that communicate only through a remote start/stop signal.

This section describes the additional features of an Intuvo 9000 GC when properly configured as part of a system with other Intelligent Instruments, such as an MS or headspace sampler (HS).



System-Level Communications

When the Intuvo 9000 GC and other Agilent instruments that support enhanced communications, such as an MS or HS, are configured together, they communicate with and react to each other. The instruments share events and data to provide interaction and efficiency. As the state of one instrument changes, the other instruments react accordingly. For example if you start to vent an MS, the GC automatically changes flows and temperatures. If the GC enters its “sleep” state to conserve resources, so do the MS and HS. When programming the HS, the HS automatically incorporates the current GC method setpoints to calculate timing and throughput.

One of the primary advantages of enhanced communications is that instruments can protect themselves and each other from damage. Events that cause this type of interaction include:

- GC shutdowns
- MS venting
- MS shutdowns

Another advantage of enhanced communications is the convenience provided at a system level:

- Consolidated EMF tracking
- Synchronized instrument clocks (requires Agilent data system)
- Synchronized instrument schedules (sleep/wake)
- Pass-through display of connected instrument errors to the GC touch screen

GC/MS Systems

This section describes GC behaviors and features that require an MS or MSD that supports enhanced GC-MS communications. (Refer to the MS documentation.)

Venting the MS

When you use the MS keypad to initiate fast venting, or when you use the Agilent data system to start venting, the MS alerts the GC. The GC loads the special MS Vent method. The GC keeps the MS Vent method loaded until:

- The MS becomes ready again.
- You manually clear the MS Vent state.

During the venting process the MS will notify the GC that venting is complete. The GC will then set very low flows at each flow- or pressure-controlled device leading back through the column configuration chain to the inlet. For example, for a configuration that uses a purged union at the transfer line, the GC will set the pressure at the purged union to 1.0 psi, and the pressure at the inlet to 1.25 psi.

If using hydrogen carrier gas, the GC will simply turn the gas off to prevent hydrogen accumulation in the MS.

Note that while in the MS Vent state, the GC will not go into MS Shutdown after losing communications with the MS.

MS Shutdown events

When configured with an MS or MSD that supports enhanced GC-MS communications, the following events will cause an MS Shutdown in the GC:

- Loss of communications with the MS, when not venting the MS. (Requires no communications for a length of time.)
- MS reports a high vacuum pump failure.

When the GC enters an MS shutdown:

- The GC aborts any current run.
- The MS transfer line temperature is turned off.
- If using a flammable carrier gas, the gas is turned off after the oven cools (for the MS column flow path only).

- If not using a flammable carrier gas, the GC will set very low flows at each flow- or pressure-controlled device leading back through the column configuration chain to the inlet. For example, for a configuration that uses a purged union at the transfer line, the GC will set the pressure at the purged union to 1.0 psi, and the pressure at the inlet to 1.25 psi.
- The GC displays the error state and notes the events in the logs.

The GC will not be usable until the error state is cleared or until the MS is unconfigured from the GC.

If the MS is repaired or clears its error, or if communications are restored, the GC will automatically clear this error state.

GC Pressure Shutdown events

If the GC goes into a pressure shutdown for the carrier gas going to the MS transfer line, the MS will log this event. As part of the shutdown steps, the GC will also turn off the MS transfer line.

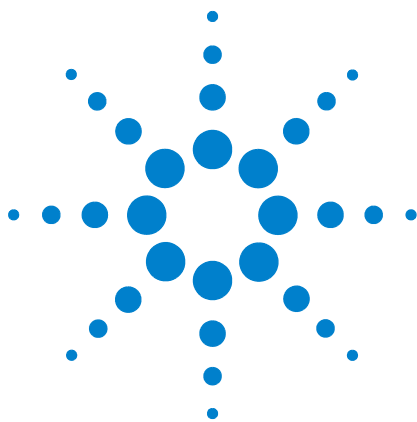

14 Operating Splitter and Backflush Accessories

G7322A Mid-Column Backflush to D1 with EPC Accessory	196
G7323A Mid-Column Backflush to D2/MS with EPC Accessory	199
G7324A Post-Column Backflush to D1 with EPC Accessory	202
G7325A Post-Column Backflush to D2/MS with EPC Accessory	206
G7326A Inlet Splitter to Two Columns Accessory	210
G7329A 1:1 D1-MS Detector Splitter Accessory	213
G3950A #886 1:1 D1-D2 Detector Splitter Accessory	217

This section provides an overview of the backflush and splitter options available to the Agilent Intuvo 9000 GC. Details and specific procedures for each accessory may be found in their respective installation instruction manuals.



G7322A Mid-Column Backflush to D1 with EPC Accessory

The Agilent G7322A Mid-Column Backflush to D1 with EPC Accessory provides capillary column backflush capabilities to the detector in the D1 position when installed on an Intuvo 9000 GC.

Introduction

Installation of the G7322A Mid-Column Backflush to D1 with EPC Accessory, which includes an electronic pressure control (EPC) module called a pneumatic switching device (PSD), provides the Agilent Intuvo 9000 GC system with backflush capability. Backflushing uses an additional pressure source at the end of a column to flow carrier gas backwards through the column and out the inlet split vent. This removes high boiling point compounds from the head of the column, which reduces carryover and matrix contaminant effects and increases sample throughput.

Principles of Operation

In a mid-column backflush setup, two columns are used. Column one is the backflush column and column two is the analytical column. An additional pressure source, the pneumatic switching device (PSD), is placed between two columns to adjust carrier gas flow in one of two modes. In regular flow operation, the PSD adds a small amount of flow in addition to the column 1 flow to provide flow to column 2. In this mode, analytes will pass from column 1 to column 2 as if it were one continuous column. The analytes are carried through column 2 to the detector. See [Figure 68](#) on page 196.

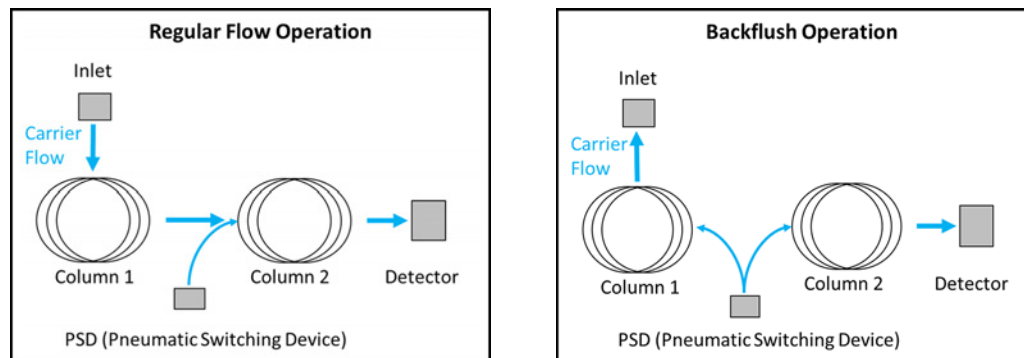

Figure 68 Regular flow and backflush operation

During backflush operation, at a specified time after sample introduction (that is, the backflush time) the inlet pressure is reduced. The PSD compensates to maintain the same flow rate through column 2 as before the backflush operation began. However, since the inlet pressure is now lower than the PSD pressure, the flow through column 1 reverses and flows out through the inlet split vent trap.

When attaching the backflush gas source line to the PSD EPC module for the backflush accessory, use a Tee fitting at the carrier gas supply, and connect the new line to the EPC module for the backflush accessory using a 1/8 inch Swagelok connection. You may need to increase the carrier gas pressure supplied to the GC, depending on the backflush settings. The PSD EPC pressure setpoint varies by application. PSD EPC purge flow should be initially set to 3 mL/min.

Operation

Column Considerations

The goal of any chromatographic separation is to obtain the necessary amount of resolution between analyte(s) of interest, while performing the separation in the fastest amount of time possible. Each analysis will be different and require different columns, but some general guidelines are as follows. A common backflush setup uses a 5 m backflush column and a 15 m analytical column. With mid-column backflush, the first column is often a coated column. The use of stationary phase (versus an uncoated backflush column) helps separate the analytes of interest from undesirable compounds and, additionally, provides phase ratio focusing for heavy analytes that will keep them at the head of the backflush column for easier backflushing. The column dimensions will vary for different samples and analyses, so choose columns that work for the required sample. Generally, the first column is a short column used to trap matrix compounds and heavy analytes, while the analytical column is as long as necessary to perform the required separation. However, the maximum length of column the Intuvo 9000 GC can handle is two 30 m x 320 μm i.d. columns.

Inlet Considerations

Any inlet that supports a split mode can be used with the mid-column backflush system.

Detector Considerations

The mid-column backflush flow chip works with any of the detectors that can be used on the Intuvo 9000 GC platform in the D1 position. The only limitation is that the detector chosen must be compatible with the flow rates coming out of column 2.

Column Flow Rate Considerations

Column two, the analytical column, should run at the optimal flow rate for the separation required. There are two main limitations regarding column flow. One is that column two be at least 10 % higher in flow than column one. For example, if column 1 is set to 2.0 mL/min, column two should be at least 2.2 mL/min or more. Additionally, the flow rate of column two should be set such that it does not exceed the operating range of the detector.

Determining Backflush Parameters

The backflush time is the specified time after sample introduction that the backflushing occurs. This is done when the last analyte of interest has eluted from column 1. The user can specify this time directly by performing a non-backflush run and estimating the time to reverse the flow in column one. Agilent also offers a Backflush Wizard which aids the user in making a series of injections to determine the optimal backflush time. The duration of backflush should be such that at least two column void volumes are flushed. (The Backflush Wizard uses five void volumes.) If carryover is observed, this value should be increased.

G7323A Mid-Column Backflush to D2/MS with EPC Accessory

The Agilent G7323A Mid-Column Backflush to D2/MS with EPC Accessory provides capillary column backflush capabilities to the detector in the D2 accessory or MS when installed on an Intuvo 9000 GC.

Introduction

Installation of the G7323A Mid-Column Backflush to D2/MS with EPC Accessory, which includes an electronic pressure control (EPC) module called a pneumatic switching device (PSD), provides the Agilent Intuvo 9000 GC system with backflush capability. Backflushing uses an additional pressure source at the end of a column to flow carrier gas backwards through the column and out the inlet split vent. This removes high boiling point compounds from the head of the column, which reduces carryover and matrix contaminant effects, avoids fouling of the mass spectrometer source, and increases sample throughput.

Principles of Operation

In a mid-column backflush setup, two columns are used. Column one is the backflush column and column two is the analytical column. An additional pressure source, the pneumatic switching device (PSD), is placed between two columns to adjust carrier gas flow in one of two modes. In regular flow operation, the PSD adds a small amount of flow in addition to the column 1 flow to provide flow to column 2. In this mode, analytes will pass from column 1 to column 2 as if it were one continuous column. The analytes are carried through column 2 to the detector. See [Figure 69](#) on page 199.

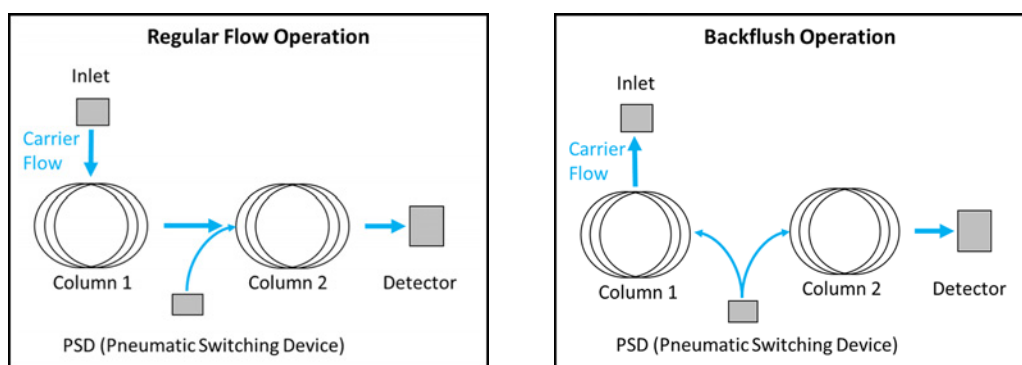

Figure 69 Regular flow and backflush operation

During backflush operation, at a specified time after sample introduction (that is, the backflush time) the inlet pressure is reduced. The PSD maintains the same flow rate through column 2. However, since the inlet pressure is now lower than the PSD pressure, the flow through column 1 reverses and flows out through the inlet split vent trap.

When attaching the backflush gas source line to the EPC module for the backflush accessory, use the same gas as the carrier gas. Use a Tee fitting at the carrier gas supply, and connect the new line to the EPC module for the backflush accessory using a 1/8 inch Swagelok connection. You may need to increase the carrier gas pressure supplied to the GC, depending on the backflush settings. The EPC pressure setpoint varies by application. EPC purge flow should be initially set to 3 mL/min.

Operation

Column Considerations

The goal of any chromatographic separation is to obtain the necessary amount of resolution between analyte(s) of interest, while performing the separation in the fastest amount of time possible. Each analysis will be different and require different columns, but some general guidelines are as follows. A common backflush setup uses a 5 m backflush column and a 15 m analytical column. With mid-column backflush, the first column is often a coated column. The use of stationary phase (versus an uncoated backflush column) helps separate the analytes of interest from undesirable compounds and, additionally, provides phase ratio focusing for heavy analytes that will keep them at the head of the backflush column for easier backflushing. The column dimensions will vary for different samples and analyses, so choose columns that work for the required sample. Generally, the first column is a short column used to trap matrix compounds and heavy analytes, while the analytical column is as long as necessary to perform the required separation. However, the maximum length of column the Intuvo 9000 GC can handle is two 30 m x 320 μm i.d. columns.

Inlet Considerations

Any inlet that supports a split mode can be used with the mid-column backflush system.

Detector Considerations

The mid-column backflush flow chip works with any of the detectors that can be used on the Intuvo 9000 GC platform. The only limitation is that the detector chosen must be compatible with the flow rates coming out of column 2.

Column Flow Rate Considerations

Column two, the analytical column, should run at the optimal flow rate for the separation required. There are two main limitations regarding column flow. One is that column two be at least 10 % higher in flow than column one. For example, if column 1 is set to 2.0 mL/min, column two should be at least 2.2 mL/min or more. Additionally, the flow rate of column two should be set such that it does not exceed the operating range of the detector (that is, MS).

Determining Backflush Parameters

The backflush time is the specified time after sample introduction that the backflushing occurs. This is done when the last analyte of interest has eluted from column 1. The user can specify this time directly by performing a non-backflush run and estimating the time to reverse the flow in column one. Agilent also offers a Backflush Wizard which aids the user in making a series of injections to determine the optimal backflush time. The duration of backflush should be such that at least two column void volumes are flushed. (The Backflush Wizard uses five void volumes.) If carryover is observed, this value should be increased.

G7324A Post-Column Backflush to D1 with EPC Accessory

The Agilent G7324A Post-Column Backflush to D1 with EPC Accessory provides capillary column backflush capabilities to the detector in the D1 position when installed on an Intuvo 9000 GC.

Introduction

Installation of the G7324A Post-Column Backflush to D1 with EPC Accessory, which includes an electronic pressure control (EPC) module called a pneumatic switching device (PSD), provides the Agilent Intuvo 9000 GC system with backflush capability. Backflushing uses an additional pressure source at the end of a column to flow carrier gas backwards through the column and out the inlet split vent. This removes high boiling point compounds from the head of the column, which reduces carryover and matrix contaminant effects, avoids fouling of the detector, and increases sample throughput.

Principles of Operation

In a post-column backflush setup, a single analytical column is used, in conjunction with a backflush restrictor situated between the end of the analytical column and the detector. The backflush restrictor is built into the Agilent G7324A Post-Column Backflush flow chip, which makes backflushing with the Intuvo 9000 GC user friendly. An additional pressure source, the PSD EPC, is connected via a node (also built into the Post-Column Backflush flow chip) between the column and the restrictor to adjust carrier gas flow in one of two modes.

In regular flow operation, the PSD EPC adds a small amount of carrier gas, in addition to the column carrier gas, to provide flow through the restrictor to the detector. In this mode, analytes will pass from the column through the restrictor to the detector as if it were one continuous column. See [Figure 70](#) on page 203.

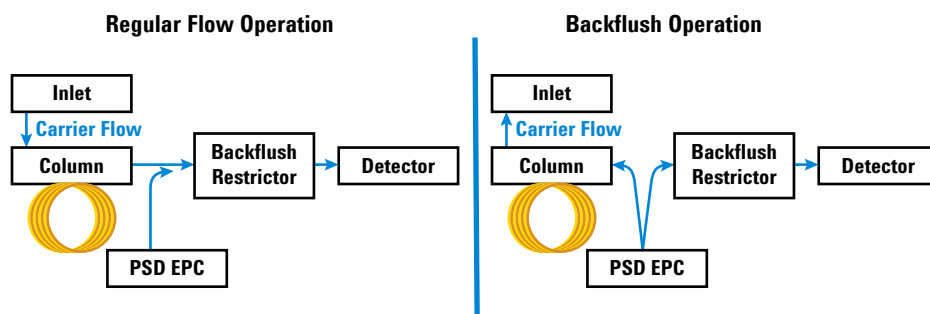

Figure 70 Regular flow and backflush operation

During backflush operation, at a specified time after sample introduction (that is, the backflush time) the inlet pressure is dropped (generally to 1-2 psi). The PSD EPC pressure is raised to reverse the flow of carrier gas and flush any remaining analytes out through the inlet split vent trap.

To enable backflush operation, the user specifies a time for the system to perform backflush. The backflush time is generally the end of the run when the last peak of interest has eluted from the column and been detected. At the backflush time, the inlet pressure is reduced while simultaneously the PSD pressure is increased. The higher the PSD pressure is raised during backflush, the faster the backflushing will occur. However, when increasing the PSD pressure during backflush, part of the flow is also sent through the restrictor to the detector. The flow during backflush cannot be greater than the operational limits of the detector.

When attaching the backflush gas source line to the EPC module for the backflush accessory, use the same gas as the carrier gas. Use a Tee fitting at the carrier gas supply, and connect the new line to the EPC module for the backflush accessory using a 1/8 inch Swagelok connection.

You may need to increase the carrier gas pressure supplied to the GC, depending on the backflush settings. The PSD EPC pressure setpoint varies by application. PSD EPC purge flow should be initially set to 3 mL/min.

Operation

General Considerations

The goal of any chromatographic separation is to obtain the necessary amount of resolution between analyte(s) of interest, while performing the separation in the fastest amount of time possible. Total analysis time is a sum of the chromatographic run time, any post-run holds required to elute high boiling (very retained) analytes, and the cooldown time before the system is thermally ready for the next run. Using post-column backflush to reverse the flow after the last analyte of interest has eluted can help reduce the amount of time spent holding at extended temperatures to elute significantly retained analytes. The flushing of the column can also help remove matrix contaminants and help avoid carryover.

Inlet Considerations

Any inlet that supports a split mode can be used with the post-column backflush system.

Detector Considerations

The post-column backflush flow chip works with any of the detectors that can be used on the Intuvo 9000 GC platform. The only limitation is that the detector chosen must be compatible with the flow rate of the column and the flow rate during backflush.

Column Flow Rate Considerations

The analytical column should be run at the optimal flow rate for the separation required. There are two main limitations regarding column flow. First, the flow provided to the backflush restrictor from the PSD should be at least 10 % higher in flow than the analytical column. For example, if column 1 is set to a flow rate of 1.0 mL/min, the flow through the backflush restrictor should be at least 1.1 mL/min, or more. Additionally, the flow rate out of the backflush restrictor should be such that it does not exceed the operating range of the detector.

Determining Backflush Parameters

The backflush time is the specified time after sample introduction that the backflushing occurs. This is done when the last analyte of interest has eluted from the system. The user can specify this time directly by performing a non-backflush run and determining the retention time of the last peak of

interest. The backflush is a post-run operation. The duration of backflush should be such that at least two column void volumes are flushed. (The Backflush Wizard uses five void volumes.) If carryover is observed, this value should be increased.

G7325A Post-Column Backflush to D2/MS with EPC Accessory

The Agilent G7325A Post-Column Backflush to D2/MS with EPC Accessory provides capillary column backflush capabilities to the detector in the D2 accessory or MS when installed on an Intuvo 9000 GC.

Introduction

Installation of the G7325A Post-Column Backflush to D2/MS with EPC Accessory, which includes an electronic pressure control (EPC) module called a pneumatic switching device (PSD), provides the Agilent Intuvo 9000 GC system with backflush capability. Backflushing uses an additional pressure source at the end of a column to flow carrier gas backwards through the column and out the inlet split vent. This removes high boiling point compounds from the head of the column, which reduces carryover and matrix contaminant effects, avoids fouling of the detector or MS, and increases sample throughput.

Principles of Operation

In a post-column backflush setup, a single analytical column is used, in conjunction with a backflush restrictor situated between the end of the analytical column and the detector or MS. The backflush restrictor is built into the Agilent G7325A Post-Column Backflush flow chip, which makes backflushing with the Intuvo 9000 GC user friendly. An additional pressure source, the PSD EPC, is connected via a node (also built into the Post-Column Backflush flow chip) between the column and the restrictor to adjust carrier gas flow in one of two modes.

In regular flow operation, the PSD EPC adds a small amount of carrier gas, in addition to the column carrier gas, to provide flow through the restrictor to the detector or MS. In this mode, analytes will pass from the column through the restrictor to the detector or MS, as if it were one continuous column.

See [Figure 71](#) on page 207.

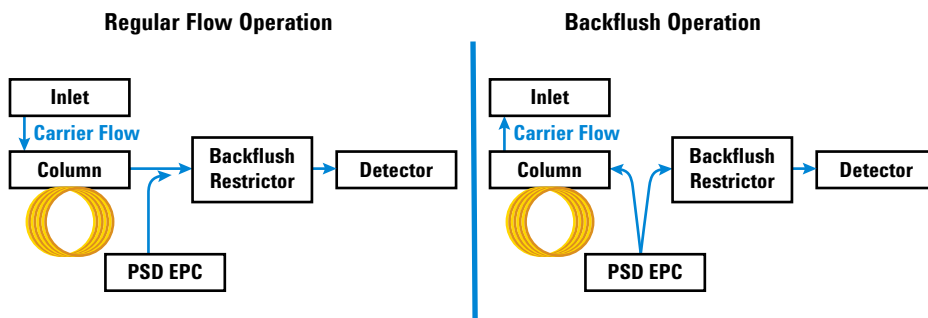

Figure 71 Regular flow and backflush operation

During backflush operation, at a specified time after sample introduction (that is, the backflush time) the inlet pressure is dropped (generally to 1-2 psi). The PSD EPC pressure is raised to reverse the flow of carrier gas and flush any remaining analytes out through the inlet split vent trap.

To enable backflush operation, the user specifies a time for the system to perform backflush. The backflush time is generally the end of the run when the last peak of interest has eluted from the column and been detected. At the backflush time, the inlet pressure is reduced while simultaneously the PSD pressure is increased. The higher the PSD pressure is raised during backflush, the faster the backflushing will occur. However, when increasing the PSD pressure during backflush, part of the flow is also sent through the restrictor to the detector or MS. The flow during backflush cannot be greater than the operational limits of the detector or MS.

When attaching the backflush gas source line to the EPC module for the backflush accessory, use the same gas as the carrier gas. Use a Tee fitting at the carrier gas supply, and connect the new line to the EPC module for the backflush accessory using a 1/8 inch Swagelok connection.

You may need to increase the carrier gas pressure supplied to the GC, depending on the backflush settings. The PSD EPC pressure setpoint varies by application. PSD EPC purge flow should be initially set to 3 mL/min.

Operation

General Considerations

The goal of any chromatographic separation is to obtain the necessary amount of resolution between analyte(s) of interest, while performing the separation in the fastest amount of time possible. Total analysis time is a sum of the chromatographic run time, any post-run holds required to elute high boiling (very retained) analytes, and the cooldown time before the system is thermally ready for the next run. Using post-column backflush to reverse the flow after the last analyte of interest has eluted can help reduce the amount of time spent holding at extended temperatures to elute significantly retained analytes. The flushing of the column can also help remove matrix contaminants and help avoid carryover.

Inlet Considerations

Any inlet that supports a split mode can be used with the post-column backflush system.

Detector Considerations

The post-column backflush flow chip works with any of the detectors that can be used on the Intuvo 9000 GC platform. The only limitation is that the detector chosen must be compatible with the flow rate of the column and the flow rate during backflush.

Column Flow Rate Considerations

The analytical column should be run at the optimal flow rate for the separation required. There are two main limitations regarding column flow. First, the flow provided to the backflush restrictor from the PSD should be at least 10 % higher in flow than the analytical column. For example, if column 1 is set to a flow rate of 1.0 mL/min, the flow through the backflush restrictor should be at least 1.1 mL/min, or more. Additionally, the flow rate out of the backflush restrictor should be such that it does not exceed the operating range of the detector.

Determining Backflush Parameters

The backflush time is the specified time after sample introduction that the backflushing occurs. This is done when the last analyte of interest has eluted from the system. The user can specify this time directly by performing a non-backflush run and determining the retention time of the last peak of

interest. The backflush is a post-run operation. The duration of backflush should be such that at least two column void volumes are flushed. (The Backflush Wizard uses five void volumes.) If carryover is observed, this value should be increased.

G7326A Inlet Splitter to Two Columns Accessory

The Agilent G7326A Inlet Splitter to Two Columns Accessory provides the capability to support two columns and two detectors fed from a single inlet when installed on an Intuvo 9000 GC.

Introduction

Installation of the G7326A Inlet Splitter to Two Columns Accessory provides the Agilent Intuvo 9000 GC system with the capability to support two columns and two detectors fed from a single inlet.

Use of the inlet splitter requires an atmospheric detector in the D1 position and either an atmospheric detector or below ambient pressure detector in the D2 position (installed D2 accessory or MSD).

Principles of Operation

The inlet splitter is used to split the effluent from the GC inlet to two, separate columns and their corresponding detectors for analyte detection.

The inlet splitter supports the use of any two Intuvo analytical columns and any combination of detectors:

Atmospheric pressure detectors:

- FID (flame ionization detector)
- TCD (thermal conductivity detector)
- NPD (nitrogen phosphorus detector)
- μ ECD (micro electron capture detector)
- FPD+ (flame photometric detector); Note: the FPD+ is not supported in the Intuvo D2 position

Below ambient pressure detectors

- MS (mass spectrometer)
- SCD (sulfur chemiluminescence detector)
- NCD (nitrogen chemiluminescence detector)

The inlet splitter is a one piece flow chip that incorporates the inlet flow chip and the detector flow chip into one piece, splitting the column flow internally. The inlet splitter is deactivated to prevent the adsorption or decomposition of

active compounds. The inlet splitter also has minimal internal volume designed to minimize any extra column band broadening.

The Intuvo Inlet Splitter is a passive device that does not require an additional pressure source (for example, a PSD EPC). The split ratio delivered by the inlet splitter is determined by the dimensions of the two analytical columns. For example, a pair of identical columns would provide a 1:1 split of the inlet effluent to both detectors. In cases where columns of dissimilar dimensions are chosen, the effective split ratio can be calculated based on the ratio of carrier flow going through each column. The carrier flow going through a given column can be determined using the Agilent Pressure/Flow Calculator included in the instrument's software driver.

Operation

Requirements

The inlet splitter requires the use of two Intuvo columns, which requires the installation and use of a second column header heater.

The inlet splitter also requires that a second detector, either a supported atmospheric detector, or a supported sub ambient detector, be installed as the second (D2) detector.

Column Considerations

The choice of the pair of columns to be used with the inlet splitter defines the effective split ratio.

Typically, the inlet splitter is used to implement a pair of columns that are matched, or are similar in restriction, to provide a 1:1 split ratio between columns. In this configuration, the stationary phase composition (that is, polarity) is typically disparate between the two columns to allow confirmatory changes in retention time of reference analytes, or to introduce changes to elution order or peak resolution between critical pairs of peaks.

Alternatively, the same column type (both in dimension and stationary phase composition) can be used for both channels of the inlet splitter while two different detectors are used.

NOTE

Column 1 connects the Intuvo Inlet to the detector in the D1 position. Column 2 connects the Intuvo Inlet to the detector in the D2 position.

Detector Considerations

The choice of detectors to use with the inlet splitter is dependent upon the application. The detector configuration is typically one of two types:

- Each detector is selective for different classes of compounds.
- One detector is designated for quantitative work and the other for qualitative identification (for example, an FID-MSD configuration).

Carrier Gas

The choice of carrier gas type, and flow rate, should be determined based on the conditions that will provide the optimal chromatographic performance for the application of interest. The choice of carrier gas flow rate should also be made based on what detectors are being used and whether or not those detectors have recommended flow rates. For example, the recommended optimal total flow rate entering an Agilent MS is 1.2 mL/min.

When setting the carrier gas flow rate, the flow rate can only be defined for Column 1. Because there is only one pressure source for supplying column flow (that is, the inlet EPC), whatever pressure is used to supply the requested Column 1 flow is what will determine the flow through Column 2.

G7329A 1:1 D1-MS Detector Splitter Accessory

The Agilent G7329A 1:1 D1-MS Detector Splitter Accessory equally splits column effluent between the detector in the GC D1 position and the connected MS, when installed on an Intuvo 9000 GC.

When attaching the gas source line to the PSD EPC module for the Intuvo 1:1 D1-MS Detector Splitter Accessory, use the same gas as the carrier gas. Use a Tee fitting at the carrier gas supply, and connect the new line to the PSD EPC module for the accessory using a 1/8 inch Swagelok connection.

The EPC pressure setpoint varies by application. EPC purge flow should be initially set to 3 mL/min.

Principles of Operation

The Intuvo 1:1 D1-MS Detector Splitter is used to split the effluent from the analytical column to two different detectors, where one detector is operated at atmospheric pressure and the other is operated at sub-ambient pressure. The D1 detector can be any of the supported atmospheric detectors. The D2 is a mass spectrometer (MS). See [Figure 72](#).

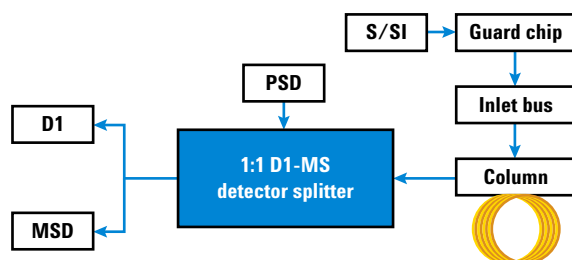

Figure 72 1:1 D1-MS Detector Splitter flow diagram

The Intuvo 1:1 D1-MS Detector Splitter requires the use of an Intuvo pneumatic switching device electronic pressure control (PSD EPC) module. The PSD EPC provides a constant pressure drop across the restrictions built into the splitter, which are necessary to compensate for the differences in operating pressure between the D1 and MS detectors.

Supported D1 atmospheric detectors:

- FID (flame ionization detector)
- TCD (thermal conductivity detector)
- NPD (nitrogen phosphorus detector)

- μ ECD (micro electron capture detector)
- FPD+ (flame photometric detector)

Supported mass spectrometers:

- 5975A, 5977A, 5977B single quadrupole MS - High Efficiency Source (HES) and non HES
- 7000 series, and 7010 triple quadrupole MS - HES and non HES

The 1:1 D1-MS Detector Splitter Chip is an active splitting device. The PSD EPC maintains a constant pressure at the split point throughout the oven temperature program. By maintaining a constant pressure at the split point, the carrier flow rate going to each detector remains constant throughout the run. Keeping the carrier flow rate constant is important to maintain a constant response on detectors such as the MS.

The split ratio delivered by the splitter is built into the 1:1 D1-MS Detector Splitter Chip. Slight differences in the split ratio of column effluent being directed to the different detectors can be achieved by changing method setpoints. However, the 1:1 D1-MS splitter chip was designed to provide a 1:1 split for a specific set of conditions: carrier gas type, PSD EPC pressure, and temperature setpoints.

Hardware Details

The Intuvo 1:1 D1-MS Detector Splitter replaces the existing detector flow chip. The splitter provides flow paths for both detectors, with restriction added to the MS path in order to achieve the 1:1 split.

The GC otherwise uses standard hardware (detector tails, inlet chip, and so on).

The PSD EPC is calibrated for control of all supported gas types and pressure/flow ranges. As a result, no special or specific flow restricting frits are required to be installed into the module.

PSD EPC

The PSD EPC should be supplied with the same gas type as the GC's inlet EPC module.

The PSD EPC has two pneumatic control channels. The first (primary) channel controls the pressure applied to the node in the 1:1 D1-MS Detector Splitter Chip where the column effluent is split. The second channel acts as an engineered bleed

restrictor for the first channel. The second channel is referred to as the Purge Flow. A typical purge flow of 3 mL/min ensures that the PSD EPC Pressure setpoint remains high enough to be easily controlled.

The purge flow exhausts through a 1/8 inch O.D. tube routed out of the back of the GC. If needed, the tube can be connected to a fume hood or other appropriate ventilation system.

PSD EPC Setpoints

Because the restrictions built into the 1:1 D1-MS Detector Splitter Chip are of predetermined size and cannot be altered, the splitter was designed to operate at a 1:1 split for the column effluent under the following, specific method setpoints:

- Carrier gas = He
- Column flow = 2.5 mL/min (constant)
- Oven program maximum temperature = 325 °C
- PSD EPC pressure = 26.2 kPa (3.8 psig)

If the actual method parameters used deviate from these setpoints, the split ratio provided by the 1:1 D1-MS Detector Splitter will also deviate from 1:1. (The actual flows being delivered to each detector at a given set of conditions will be displayed in the PSD EPC section of the method editor on the GC.) The split ratio performance is most sensitive to deviations in temperature and carrier gas type.

Columns

Because the PSD EPC controls the pressure at the column effluent splitting node, the choice of column is independent of the detector splitting. The pressure of the inlet is adjusted appropriately to compensate for the outlet of the analytical column being at the PSD EPC pressure.

Typically, MS methods will use constant flow mode. However, by correctly controlling the inlet pressure based on the PSD EPC defining the outlet pressure, all modes of column operation are still accessible: constant pressure, constant flow, ramped pressure, or ramped flow. For pressure-controlled modes, you will need to use a flow calculator or method translator utility to adjust the inlet pressure setpoints.

MSD Tuning

It is recommended that the MS be re-tuned once the 1:1 D1-MS Detector Splitter has been installed and the Intuvo actuals have achieved their method setpoints. This will ensure that the MS was tuned with the same flow entering its ion source as during the analytical run.

Carrier Gas

The carrier gas flow rate should be 2.5 mL/min. The choice of carrier gas type and flow rate should be determined based on the conditions that will provide the optimal chromatographic performance for the application of interest.

Quick Column Swap

In addition to providing the 1:1 D1-MS Detector Splitter pressure, the PSD EPC can also be used to maintain flow to the MS without the need for venting the MS, while performing inlet maintenance or column replacement.

To perform column or inlet maintenance with the 1:1 D1-MS Detector Splitter, do the following:

- 1 Cool down the inlet.
- 2 Ensure that the PSD EPC pressure is ³ 26.2 kPa (3.8 psig).
- 3 Remove the existing column.
- 4 Install the new column into the flow path. Use the Intuvo torque driver to tighten only the bolt for the connection to the inlet flow chip.
- 5 Turn on the carrier gas to purge air from the column.
- 6 Use the Intuvo torque driver to tighten the bolt of the column exit to the detector splitter.
- 7 Return the splitter pressure to the original setpoint.

G3950A #886 1:1 D1-D2 Detector Splitter Accessory

The Agilent G3950A #886 1:1 D1-D2 Detector Splitter Accessory splits the effluent from the analytical column to two different detectors, each operating at atmospheric pressure, when installed on an Intuvo 9000 GC.

Introduction

The G3950A #886 1:1 D1-D2 Detector Splitter Accessory is used to split the effluent from the analytical column to two different detectors, each operating at atmospheric pressure, when installed on the Agilent Intuvo 9000 GC.

Principles of Operation

As mentioned above, the G3950A #886 1:1 D1-D2 Detector Splitter Accessory is used to split the effluent from the analytical column to two different detectors, each operating at atmospheric pressure.

The detector splitter is passive, in that it does not require the use of an Intuvo pneumatic switching device electronic pressure control (PSD EPC) module. Based on the outlet pressure of both the D1 and D2 detectors being at atmospheric pressure, the column effluent is evenly split between the two detectors. See [Figure 73](#).

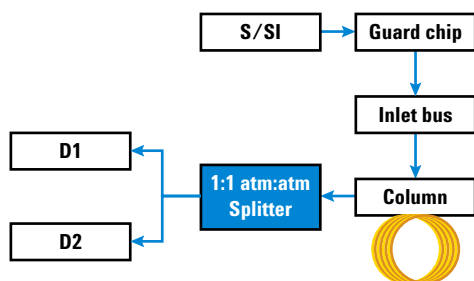

Figure 73 Principles of operation

The detector splitter supports the use of any combination of detectors from each of the following two groups.

Atmospheric pressure detectors for D1:

- FID (flame ionization detector)
- TCD (thermal conductivity detector)
- NPD (nitrogen phosphorus detector)

- μ ECD (micro electron capture detector)
- FPD+ (flame photometric detector)

Atmospheric pressure detectors for D2:

- FID (flame ionization detector)
- TCD (thermal conductivity detector)
- NPD (nitrogen phosphorus detector)
- μ ECD (micro electron capture detector)

Operation

Column Considerations

The detector splitter is installed post column, so the use of the splitter does not introduce any stipulations regarding which columns can be used.

Detector Considerations

The choice of detectors to use with the detector splitter is not dependent on the use of the splitter. However, since the injected amount will be split evenly between the two detectors, the user should take care when working at trace concentration levels if using detectors with disparate limits of detection.

Carrier Gas Considerations

The choice of carrier gas type and flow rate is not impacted by the use of the detector splitter.

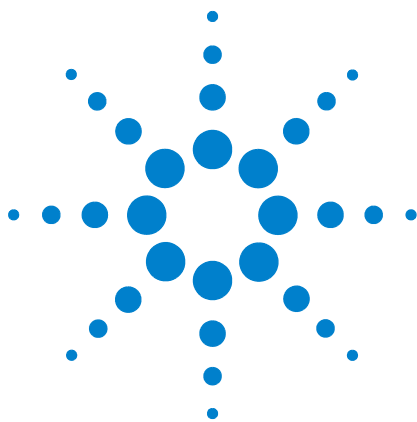

15 Chinese Metrology Testing

FPD+ and ECD Unit Conversion Factors 220

Conversion factors for the FPD+ 220

Conversion factor for the ECD 221

Using the Conversion Factors 222

References 223

The 9000 GC complies with the following company standard:
Q31/0115000033C005-2016-02.

China Metrology testing of the 9000 GC is performed in accordance with company standard Q31/0115000033C005-2016-02. This chapter provides information and techniques to correctly identify noise and drift when testing an FPD+ or ECD.



FPD⁺ and ECD Unit Conversion Factors

At the time of publication, China Metrology testing requires noise and drift metrics as shown below:

Detector	Reporting units
FID	A
TCD	mV
NPD	A
FPD ⁺	A
ECD	mV

However, data collection is required to come through the digital output available through the GC and data system. For the FID, NPD, and TCD, the data system provides data in the desired reporting units. However, for the ECD and FPD⁺, Agilent reports output to its data systems in “display units,” (DU). This section describes how to accurately convert/scale the FPD⁺ and ECD digital results to make them consistent with Chinese Metrology requirements.

The conversion factors for the FPD⁺ and ECD take the display unit output from the Agilent data system digital path to an absolute value for current or voltage. Agilent developed the conversion factors empirically, based on measurements from a single system that simultaneously output both the digital and analog data. The conversion factors also incorporate:

- The scaling applied to analog versus digital signals
- An analog signal range setting of 5 (2⁵) at the GC
- The unique filtering applied by the 35900 ADC
- The differences in bandwidth (BW) associated with the GC digital channel (5 Hz) and the 35900 ADC analog path (3 Hz)

The differences in channel bandwidth between the analog and digital signal paths can be taken into consideration as follows:

$$BW = 35900 \text{ ADC path} / \text{GC digital path} = \sqrt{(3 \text{ Hz} / 5 \text{ Hz})} = 0.7$$

Conversion factors for the FPD⁺

For the FPD⁺, the conversion factor is the same whether the phosphorus or sulfur filter is used:

$$\text{FPD}^+ \text{ (phosphorus): } 1 \text{ DU} = 1 \times 10^{-12} \text{ A}$$

$$\text{FPD}^+ \text{ (sulfur): } 1 \text{ DU} = 1 \times 10^{-12} \text{ A}$$

Conversion factor for the ECD

For the ECD, the China Metrology standard was established based on an earlier model ECD. Agilent relates display units and Hz (the base unit of measure for the ECD) at a different ratio for the ECD compared to the ECD used to develop the standard. The ECD correlates a DU to 1 Hz, whereas the older ECD correlates 1 DU to 5 Hz. Therefore the conversion also includes the difference in the digital signal reporting between the ECD and the ECD. To convert the ECD noise output into a value comparable to the CMC specification, use the following formula:

$$\text{ECD: } 1 \text{ DU} = 0.2 \text{ mV}$$

The ECD conversion factor shows that the comparable conversion factor for the ECD would be $1 \text{ mV/DU} = 1 \text{ mV/1 Hz}$.

Using the Conversion Factors

To use the conversion factors, multiply the ASTM noise reported from the Agilent data system for the GC digital signal path by the appropriate conversion factor.

For example, consider applying the FPD⁺ and ECD conversion factors to a statistical sampling of digital noise performances measured for both detectors at Agilent:

Average FPD⁺ ASTM noise, DU^{*†}: 1.54

Average ECD ASTM noise, DU[‡]: 0.16

Applying the conversion factors:

FPD⁺: $1.54 \text{ DU} \times (1 \times 10^{-12} \text{ A/1 DU}) = 1.54 \times 10^{-12} \text{ A}$

ECD: $0.16 \text{ DU} \times (0.2 \text{ mV/1 DU}) = 0.032 \text{ mV}$

*. Agilent data for FPD+ noise in this example represents sulfur mode only.

†. Data collected for purposes of comparison should be acquired with a nominal FPD offset of < 100 DU in sulfur mode and < 20 DU in phosphorus mode and at a data rate of 5 Hz.

‡. Data collected for purposes of comparison should be acquired with a nominal ECD baseline at or below 150 DU and at a data rate of 5 Hz.

References

“Calculation of Performance Factors for the HP 6890 Gas Chromatograph Using Different Data Handling Devices” Agilent Technologies publication 5964-0282E.

“Calculation of Performance Factors for the HP 6890 Gas Chromatograph Using Different Data Handling Devices” Agilent Technologies publication 5091-9207E.

“Calculation of Performance Factors for the HP 6890 Gas Chromatograph Using Different Data Handling Devices” Agilent Technologies publication 5965 8901E.

